

Holz-Metallfenster

System : M-4 75/78

„top class“

Vermasste Standard-Details

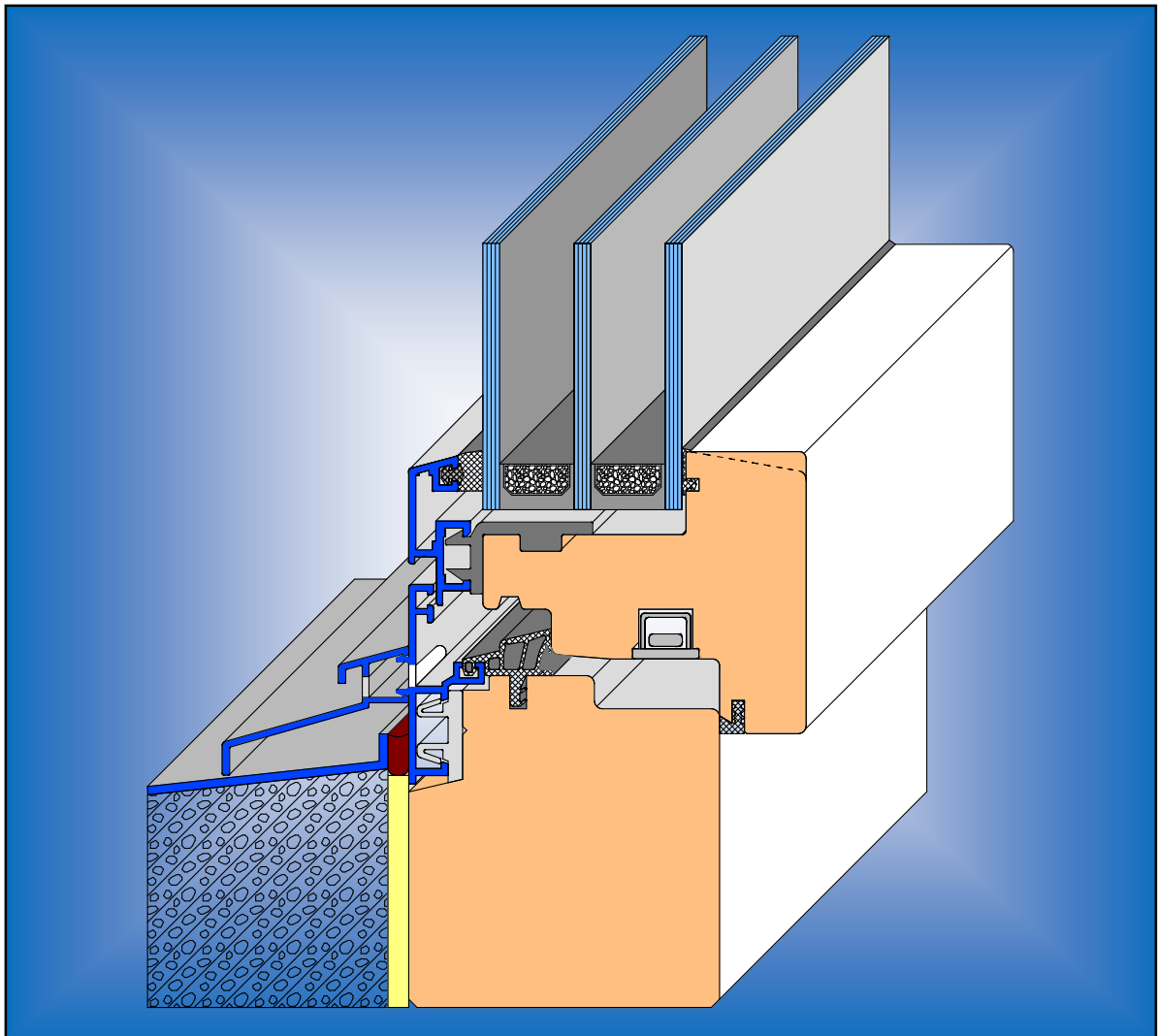

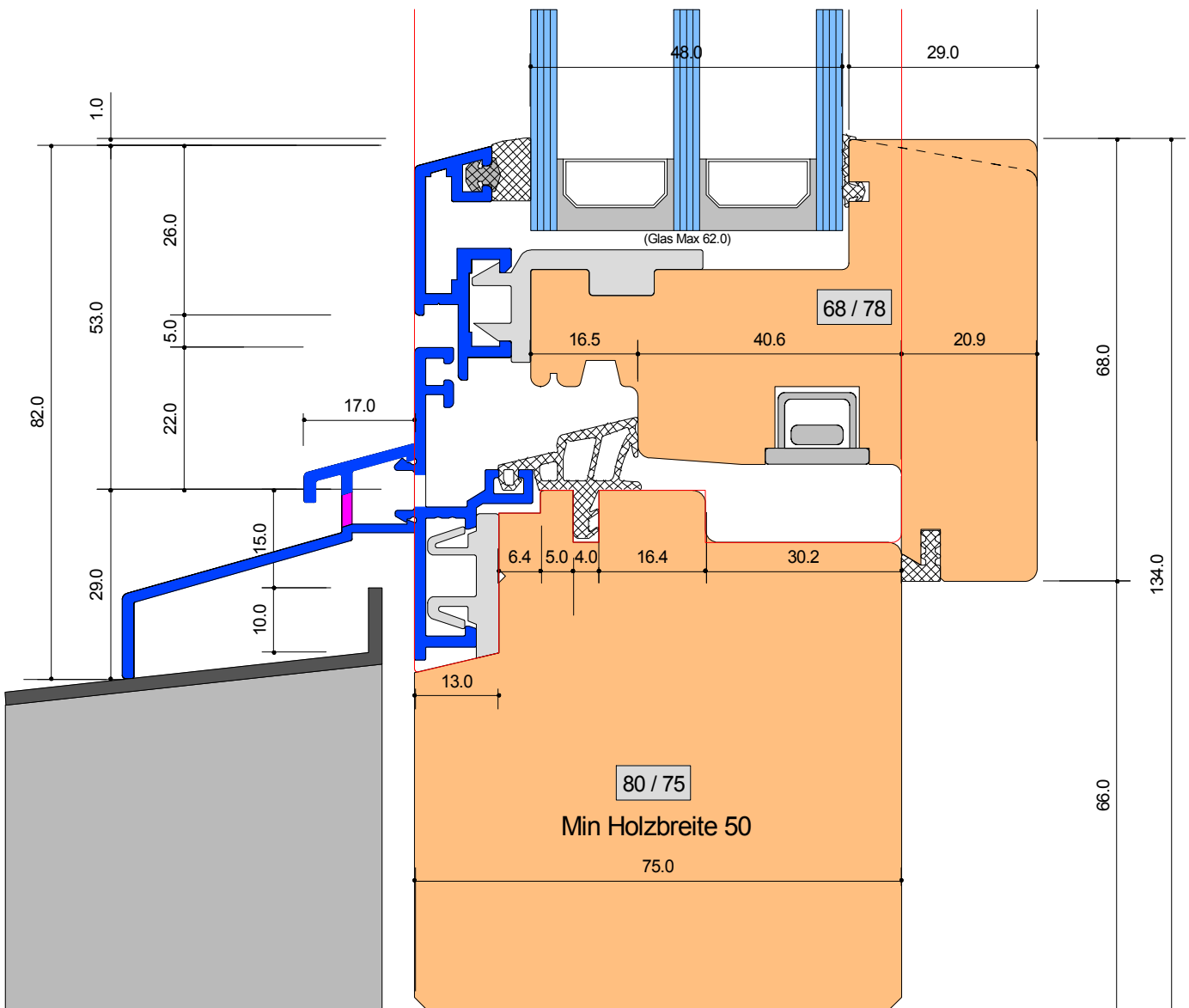

SYSTEM: M-4 75-78

Anschluss unten mit Alu Fensterbank
Wetterschenkel Typ RWS 045-013

Detail-Nr :	M - 4	D=001
-------------	-------	-------



Von Euw Fenster AG
Schoosstrasse 2
6418 Rothenthurm

Tel 041 839 80 50
Fax 041 839 80 60
mail info@voneuw.ch

Ersteller: Adi von Euw
Datum: 22.02.16
Revidiert:

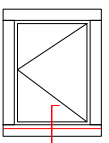

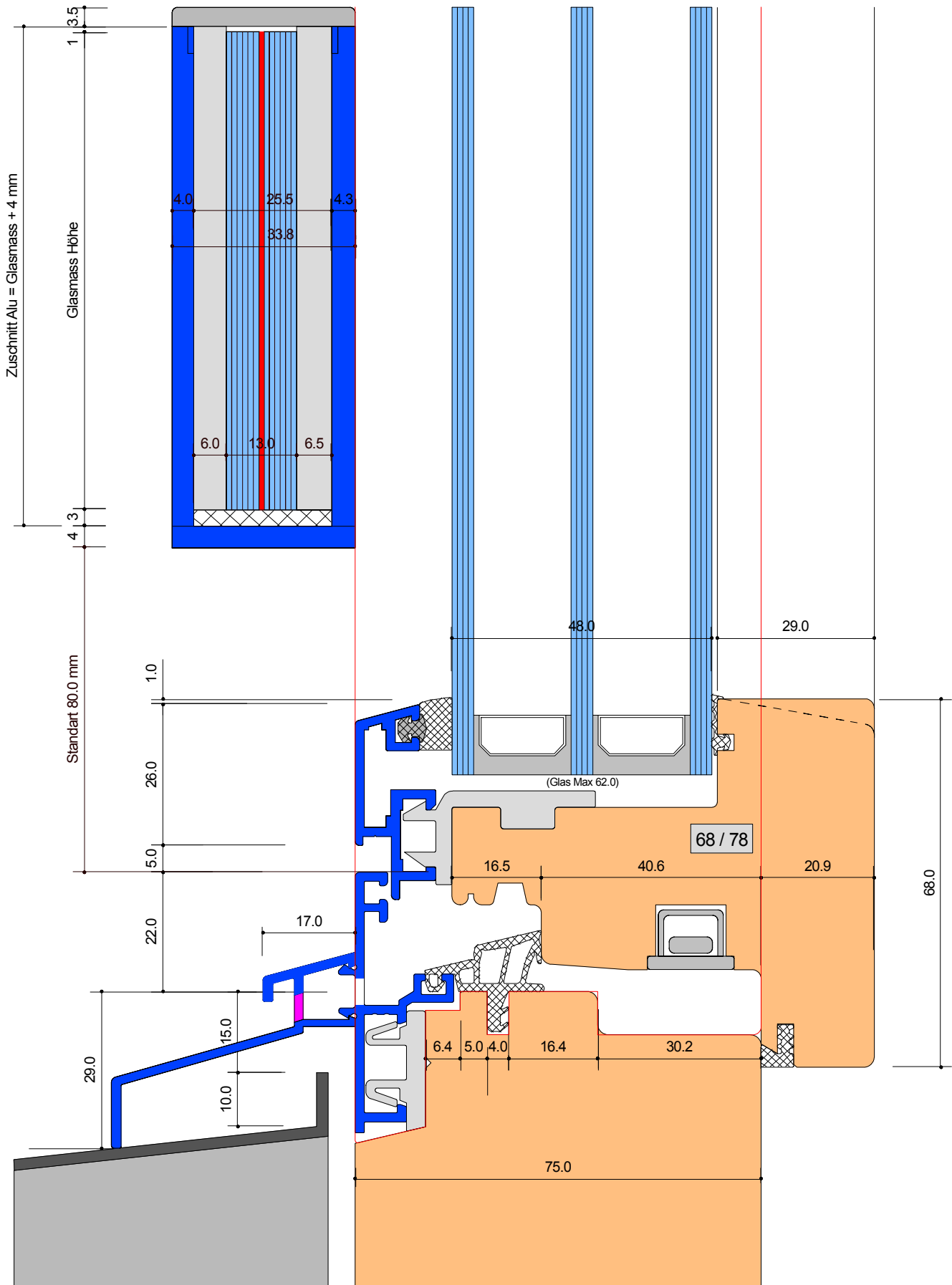

SYSTEM: M-4 75-78

Anschluss unten mit Alu Fensterbank
 Wetterschenkel Typ RWS 045-013
 mit Brüstungsglas VSG 12-2

Detail-Nr : M - 4 D=001G



Von Euw Fenster AG
 Schoosstrasse 2
 6418 Rothenthurm

Tel 041 839 80 50
 Fax 041 839 80 60
 mail info@voneuw.ch

Ersteller: Adi von Euw
 Datum: 27.03.17
 Revidiert:

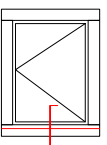

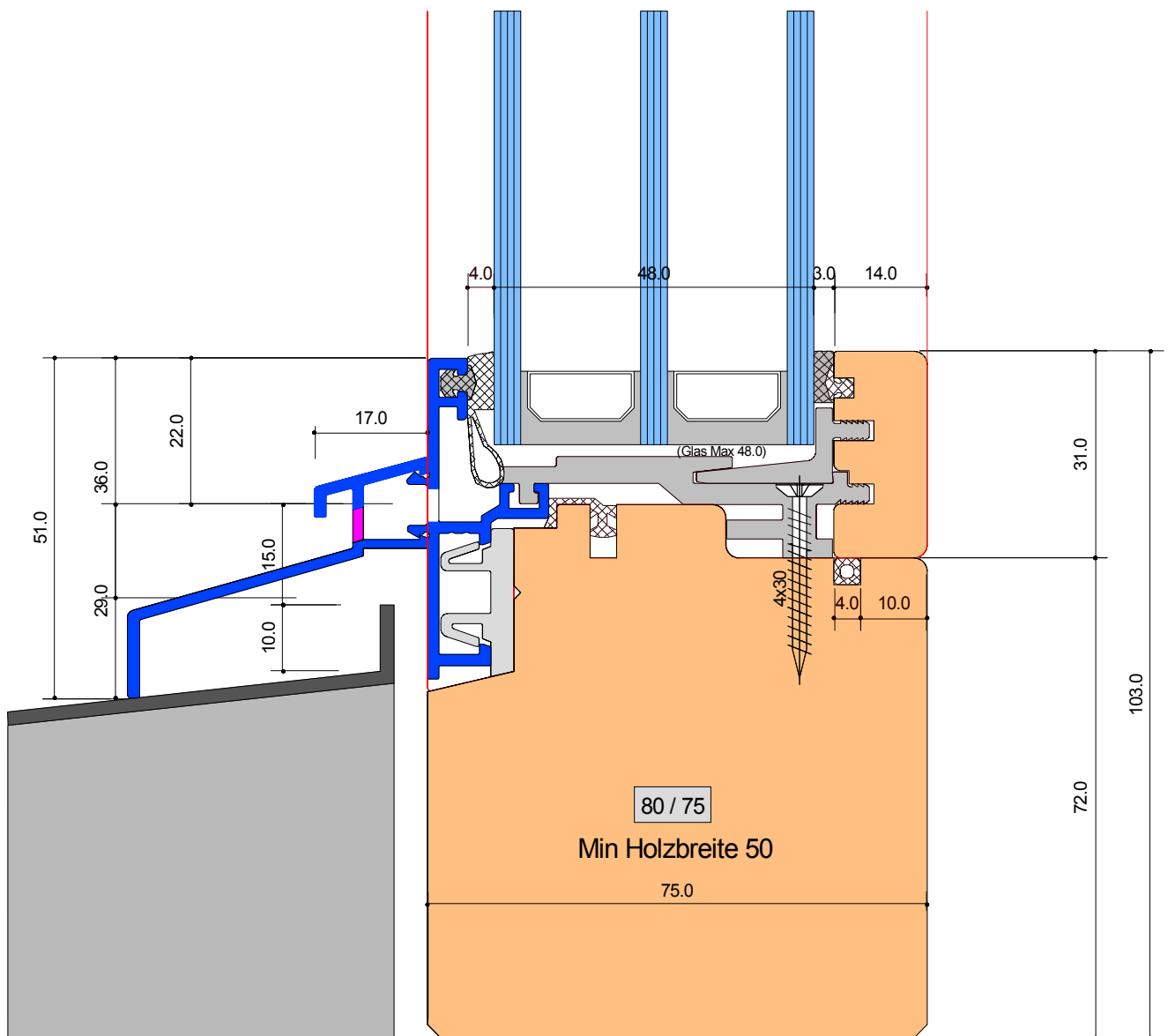

SYSTEM: M-4 75-78

Fest i.R. verglast
Wetterschenkel Typ RWS 045-013

Detail-Nr :	M-4	D=001R
-------------	-----	--------



Von Euw Fenster AG
Schoosstrasse 2
6418 Rothenthurm

Tel 041 839 80 50
Fax 041 839 80 60
mail info@voneuw.ch

Ersteller: Adi von Euw
Datum: 23.11.16
Revidiert:

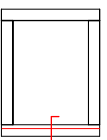

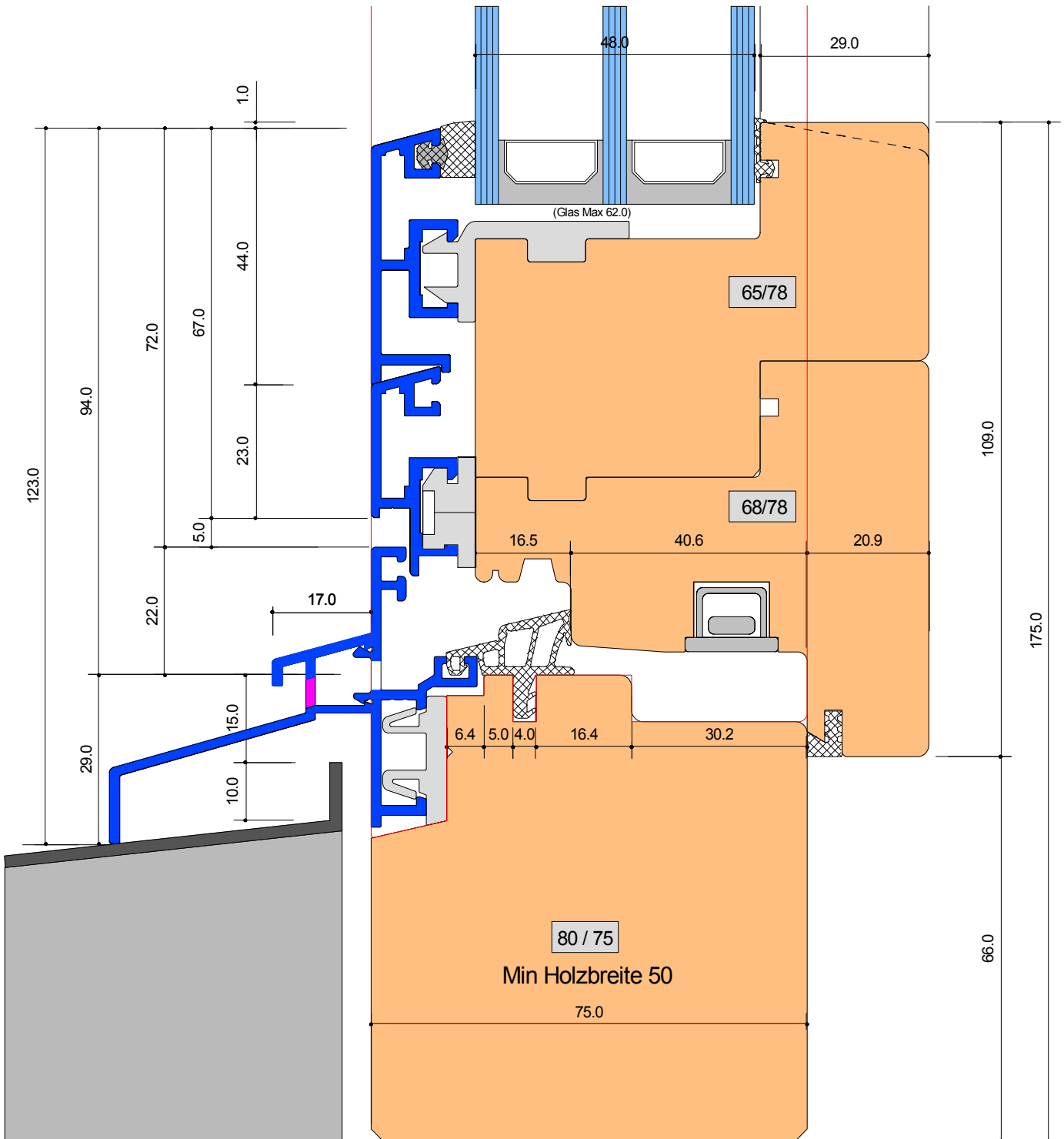

SYSTEM: M-4 75-78

Anschluss unten BT 109 mm
Wetterschenkel Typ RWS 045-013

Detail-Nr :	M - 4	D=005
-------------	-------	-------



Von Euw Fenster AG
Schoosstrasse 2
6418 Rothenthurm

Tel 041 839 80 50
Fax 041 839 80 60
mail info@voneuw.ch

Ersteller: Adi von Euw
Datum: 22.02.16
Revidiert:

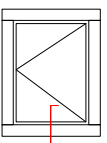

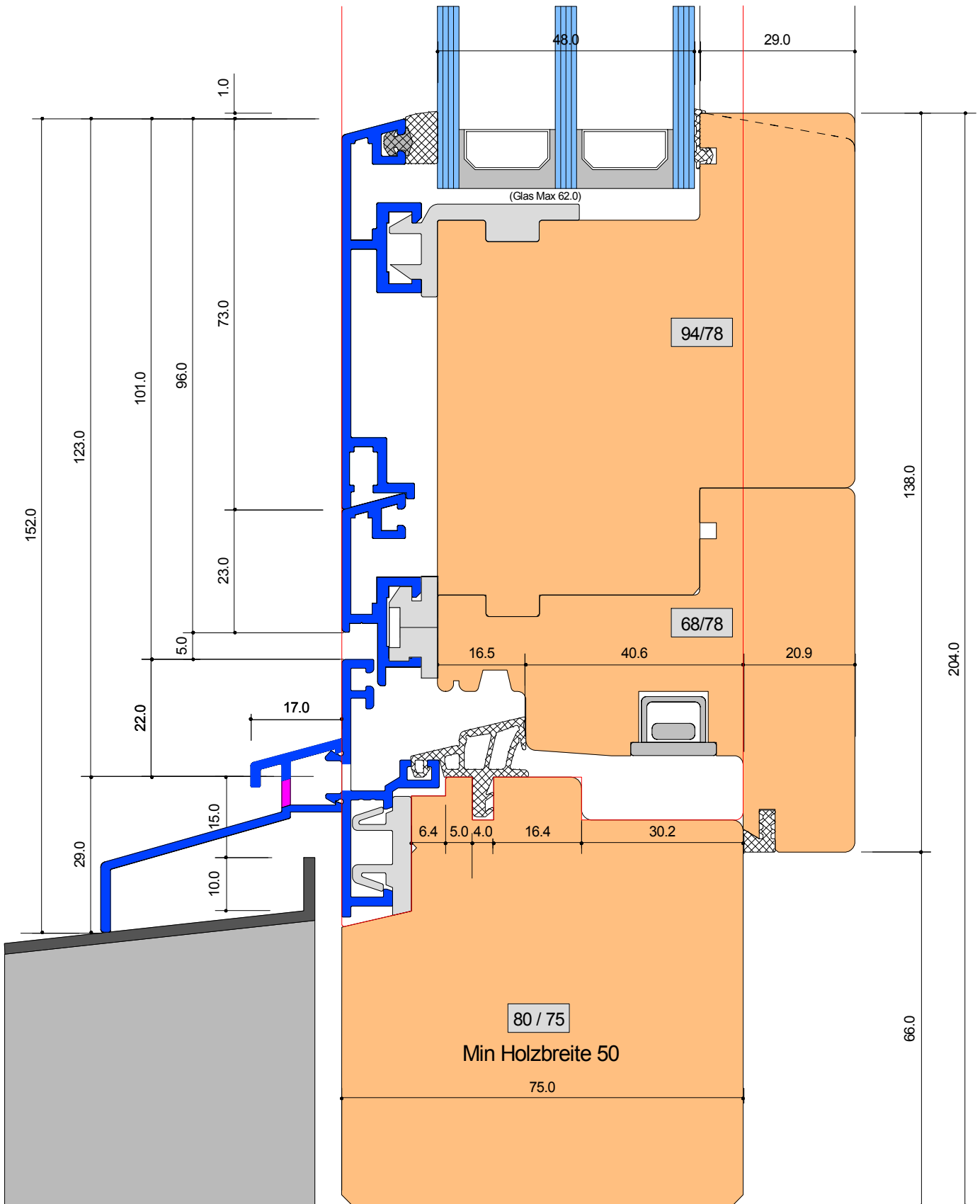

SYSTEM: M-4 75-78

Anschluss unten BT 138 mm
Wetterschenkel Typ RWS 045-013

Detail-Nr :	M - 4	D=006
-------------	-------	-------



Von Euw Fenster AG
Schoosstrasse 2
6418 Rothenthurm

Tel 041 839 80 50
Fax 041 839 80 60
mail info@voneuw.ch

Ersteller: Adi von Euw
Datum: 22.02.16
Revidiert:

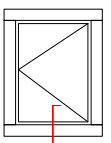

Behindertengerecht

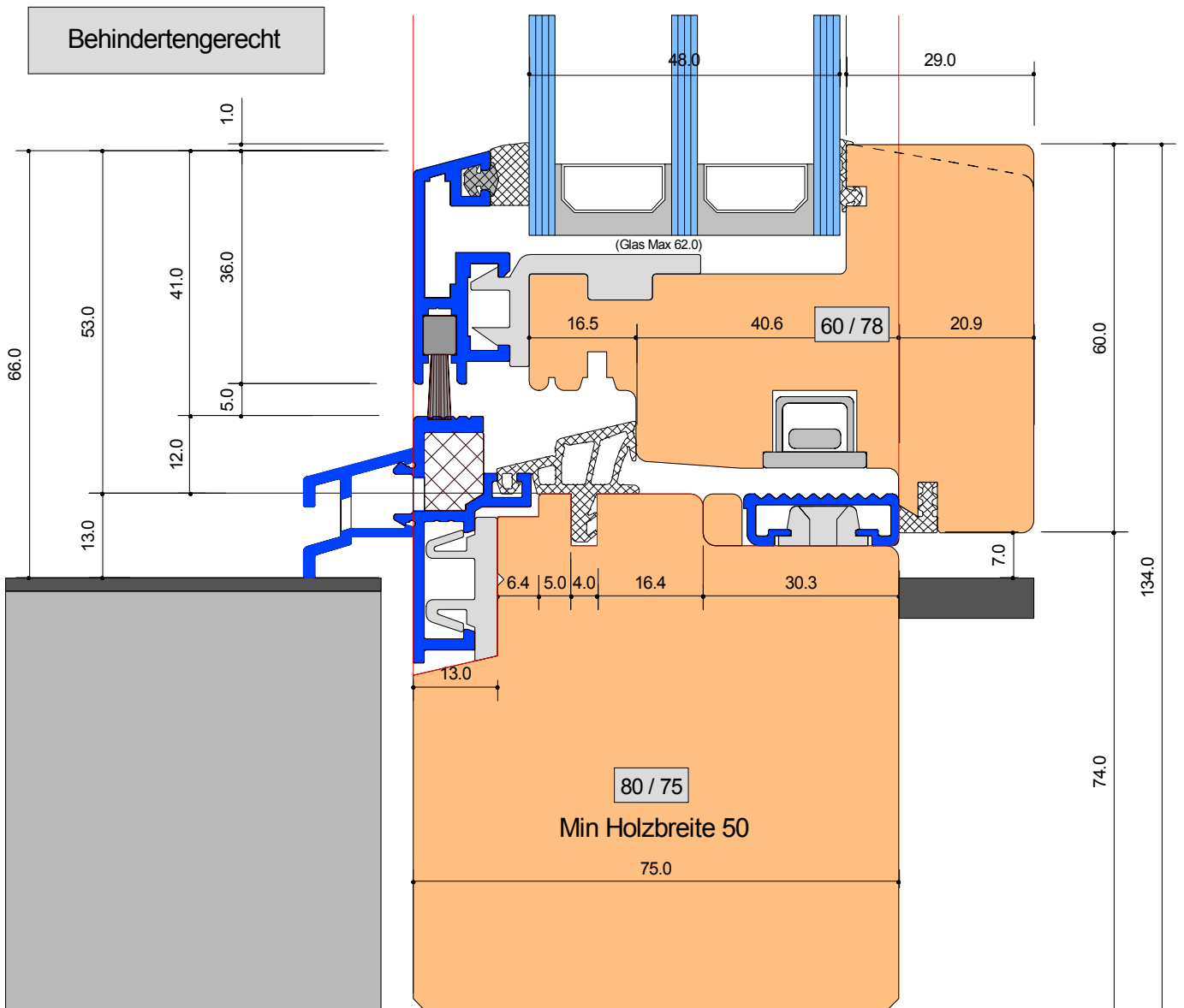

SYSTEM: M-4 75-78

Anschluss unten Rollstuhlgängig
 Mit Flügelbreite 60 mm (-8.0mm)
 Grundprofil M1-GR 038-18 Roll / Steckteil Variabel

Detail-Nr :	M - 4	D=021
-------------	-------	-------



Von Euw Fenster AG
 Schoosstrasse 2
 6418 Rothenthurm

Tel 041 839 80 50
 Fax 041 839 80 60
 mail info@voneuw.ch

Ersteller: Adi von Euw
 Datum: 22.02.16
 Revidiert: 05.11.19

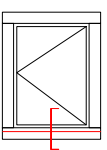

Behindertengerecht

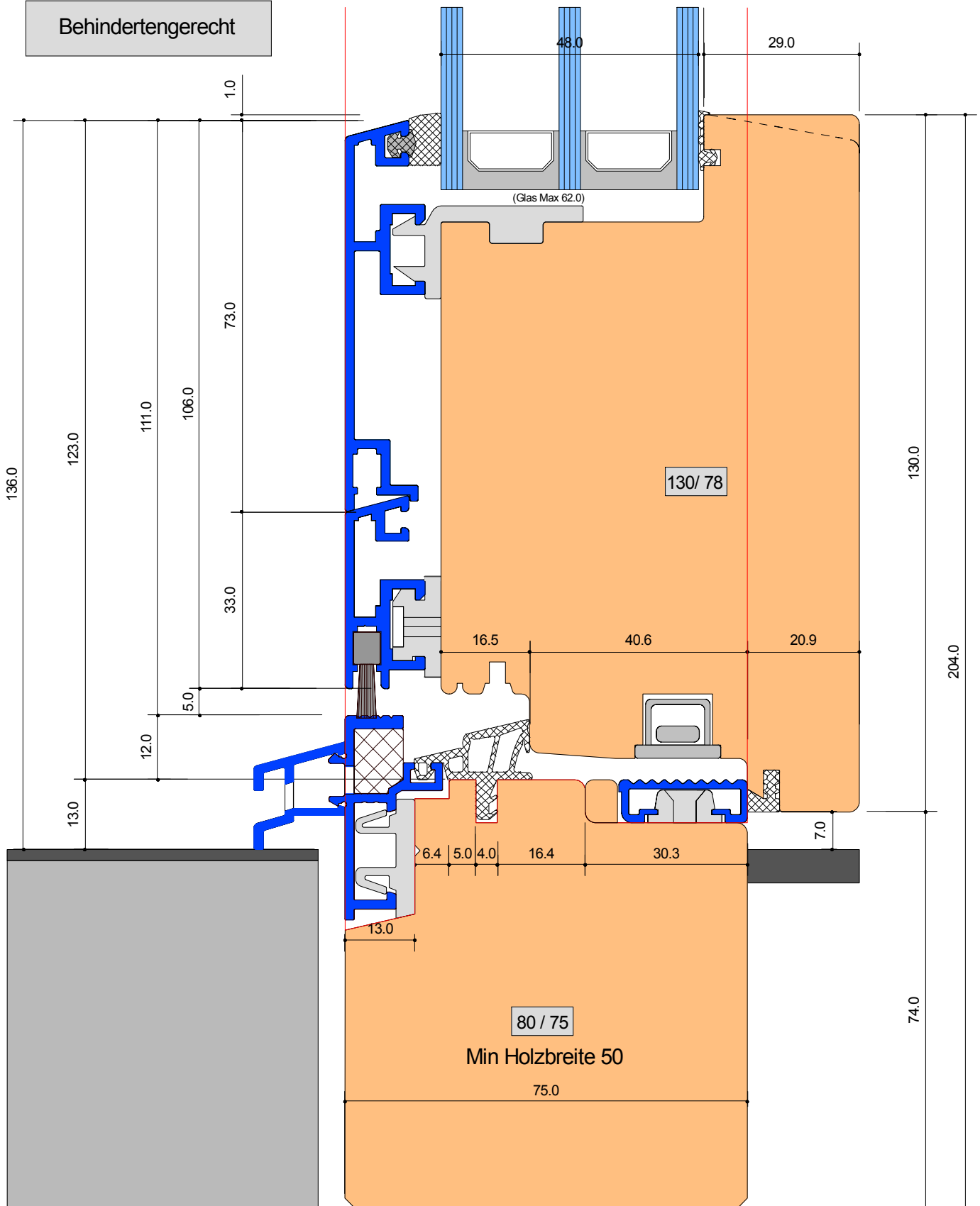

SYSTEM: M-4 75-78

Anschluss unten Rollstuhlgängig 130 mm
 Mit Flügelbreite 130 mm (-8.0)
 Grundprofil M1-GR 038-18 Roll / Steckteil Variabel

Detail-Nr : M - 4 D=023



Von Euw Fenster AG
 Schoosstrasse 2
 6418 Rothenthurm

Tel 041 839 80 50
 Fax 041 839 80 60
 mail info@voneuw.ch

Ersteller: Adi von Euw
 Datum: 22.02.16
 Revidiert: 05.11.19

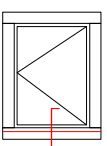

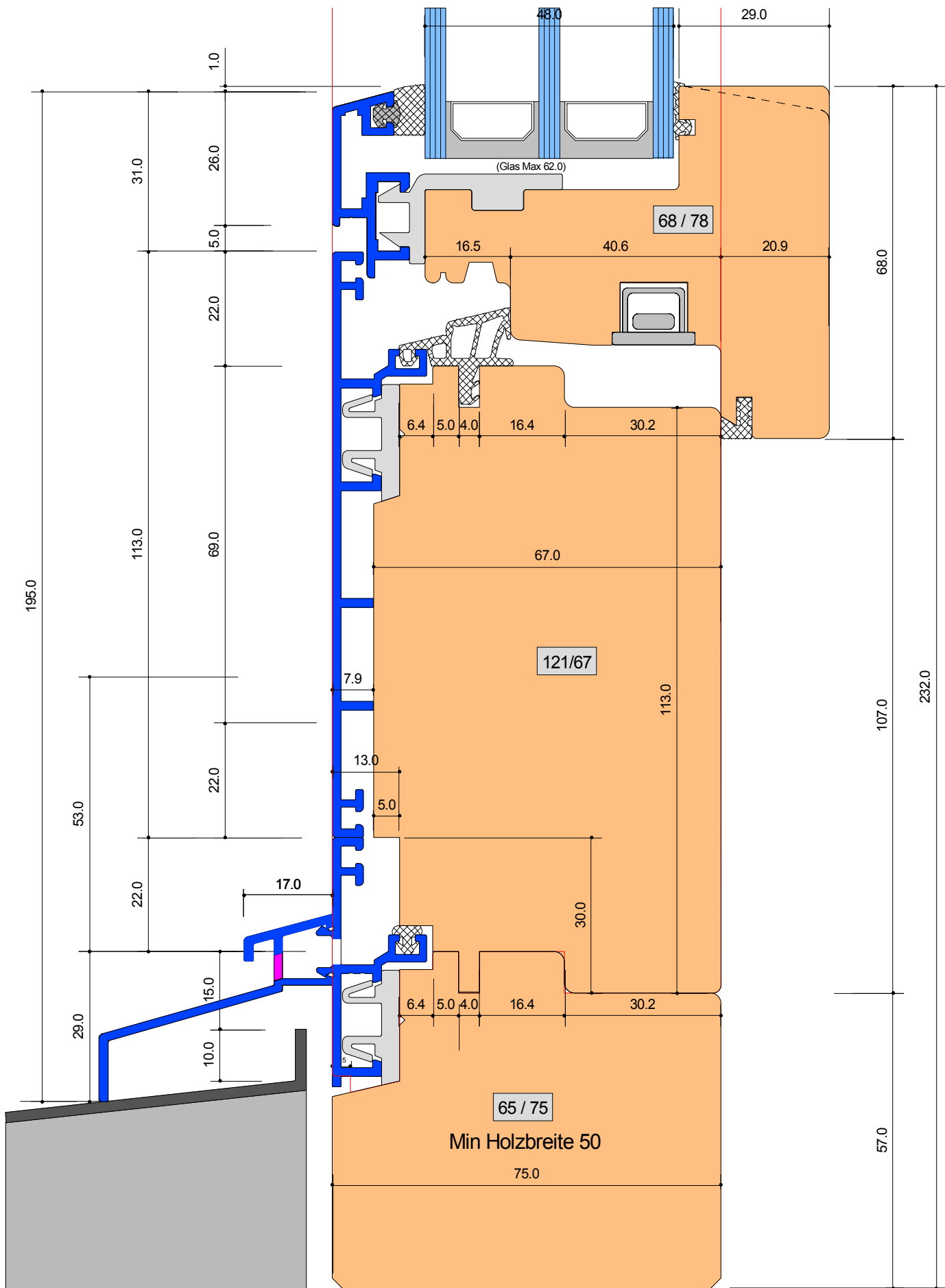

SYSTEM: M-4 75-78

Anschluss unten mit Einleimer
Wetterschenkel Typ RWS 045-013

Detail-Nr : M - 4 D=031



Von Euw Fenster AG
Schoosstrasse 2
6418 Rothenthurm

Tel 041 839 80 50
Fax 041 839 80 60
mail info@voneuw.ch

Ersteller: Adi von Euw
Datum: 22.02.16
Revidiert:

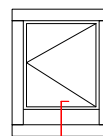

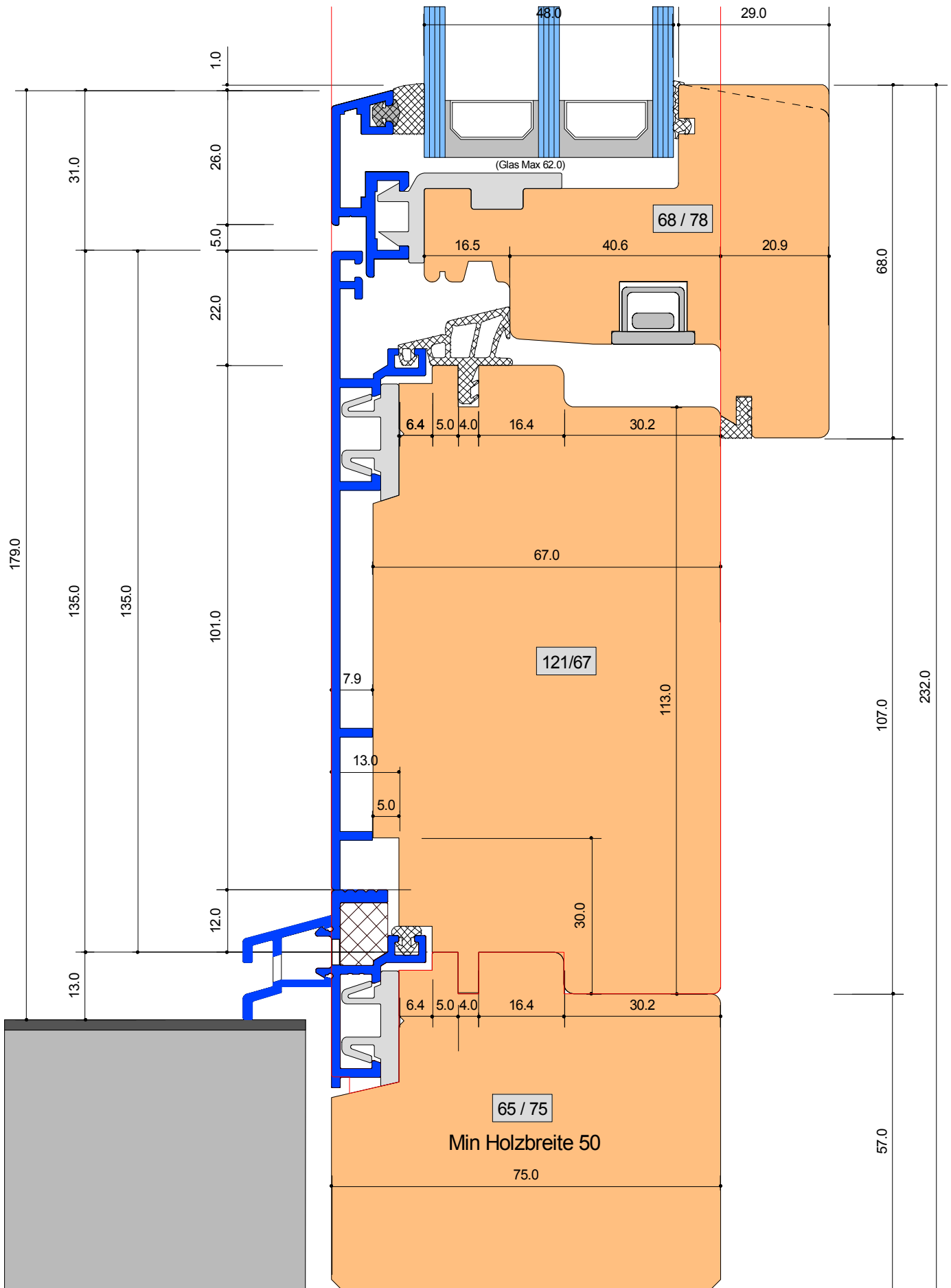

SYSTEM: M-4 75-78

Anschluss unten Rollstuhlgängig mit Einleimer
 Grundprofil M1-GR 038-18 Roll / Steckteil Variabel

Detail-Nr : M - 4 D=035



Von Euw Fenster AG
 Schoosstrasse 2
 6418 Rothenthurm

Tel 041 839 80 50
 Fax 041 839 80 60
 mail info@voneuw.ch

Ersteller: Adi von Euw
 Datum: 22.02.16
 Revidiert: 05.11.19

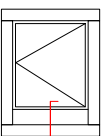

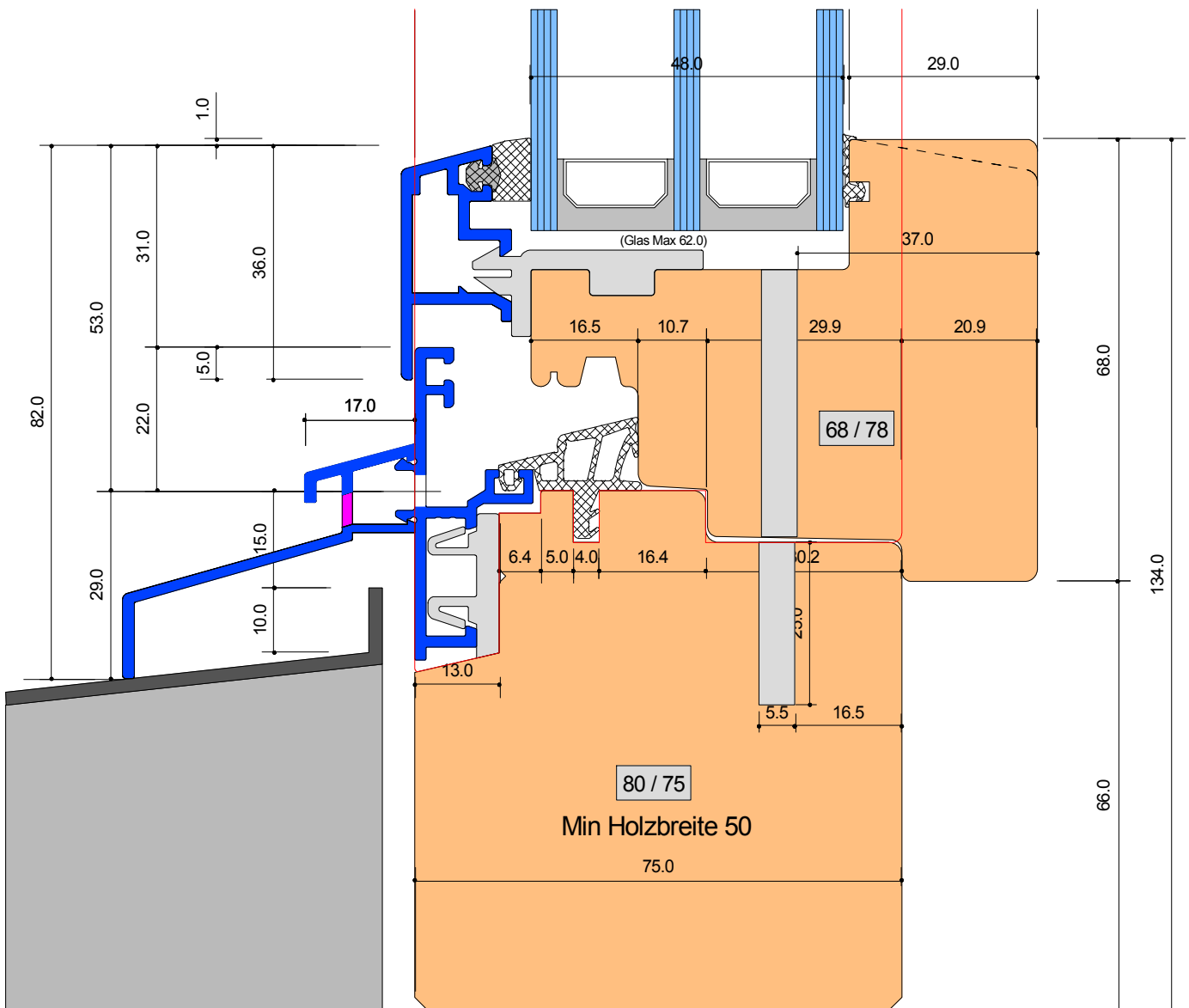

SYSTEM: M-4 75-78

Anschluss unten mit Alu Fensterbank
 Wetterschenkel Typ RWS 045-013
 Fest verglast von aussen eingesetzt Fig 68 mm

Detail-Nr : M - 4 D=041



Von Euw Fenster AG
 Schoosstrasse 2
 6418 Rothenthurm

Tel 041 839 80 50
 Fax 041 839 80 60
 mail info@voneuw.ch

Ersteller: Adi von Euw
 Datum: 22.02.16
 Revidiert:

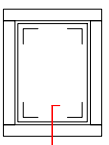

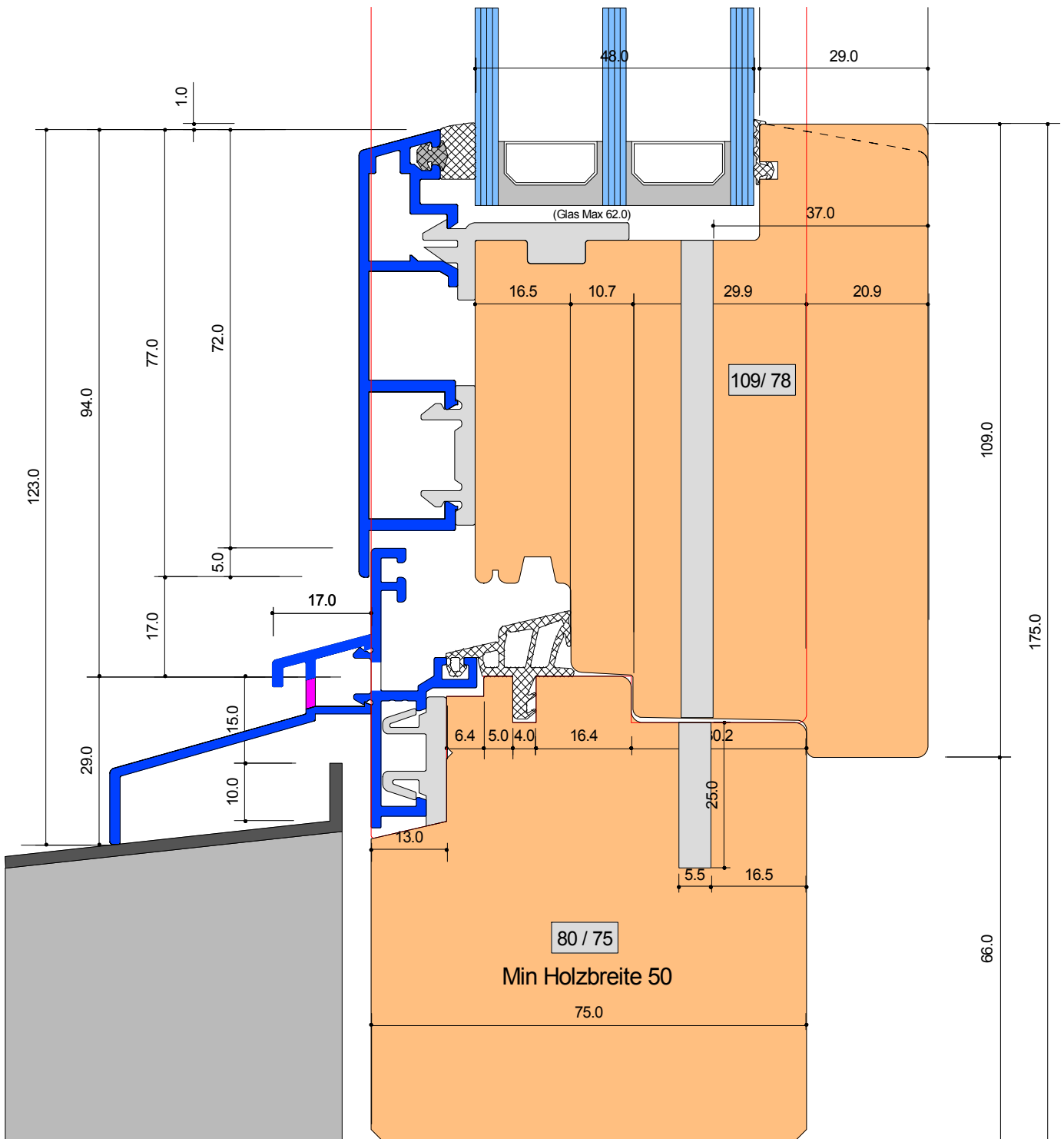

SYSTEM: M-4 75-78

Anschluss unten mit Alu Fensterbank
 Wetterschenkel Typ RWS 045-013
 Fest verglast von aussen eingesetzt Fig 109 mm

Detail-Nr : M - 4 D=042



Von Euw Fenster AG
 Schoosstrasse 2
 6418 Rothenthurm

Tel 041 839 80 50
 Fax 041 839 80 60
 mail info@voneuw.ch

Ersteller: Adi von Euw
 Datum: 22.02.16
 Revidiert:

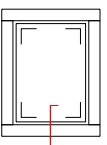

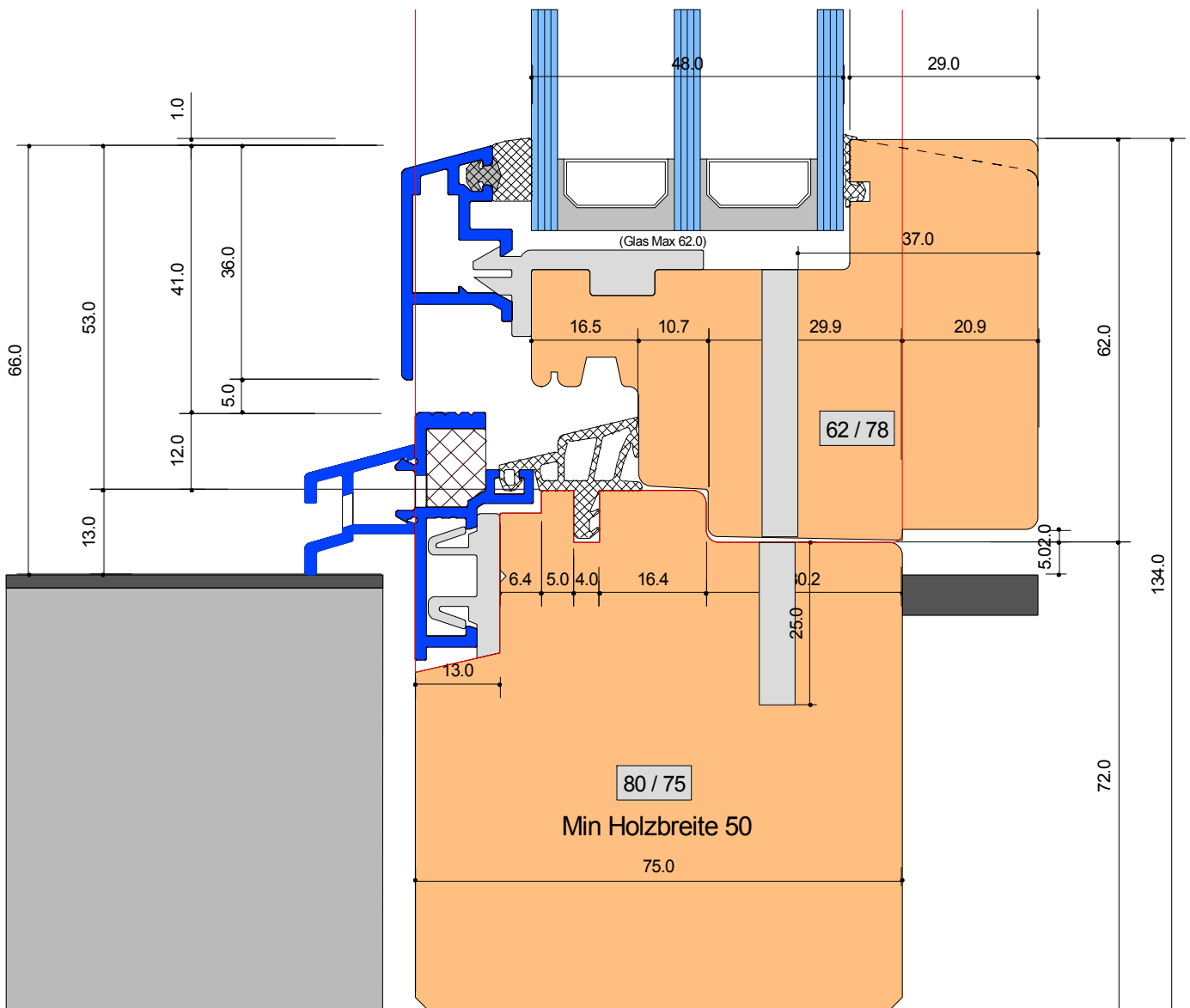

SYSTEM: M-4 75-78

Anschluss unten Rollstuhlgängig
 Standart Flügelbreite 62 mm (-6.0mm) Fest vergl.v.aussen
 Grundprofil M1-GR 038-18 Roll / Steckteil Variabel

Detail-Nr : M - 4 D=045



Von Euw Fenster AG
 Schoosstrasse 2
 6418 Rothenthurm

Tel 041 839 80 50
 Fax 041 839 80 60
 mail info@voneuw.ch

Ersteller: Adi von Euw
 Datum: 22.02.16
 Revidiert: 05.11.19

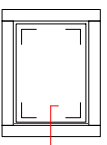

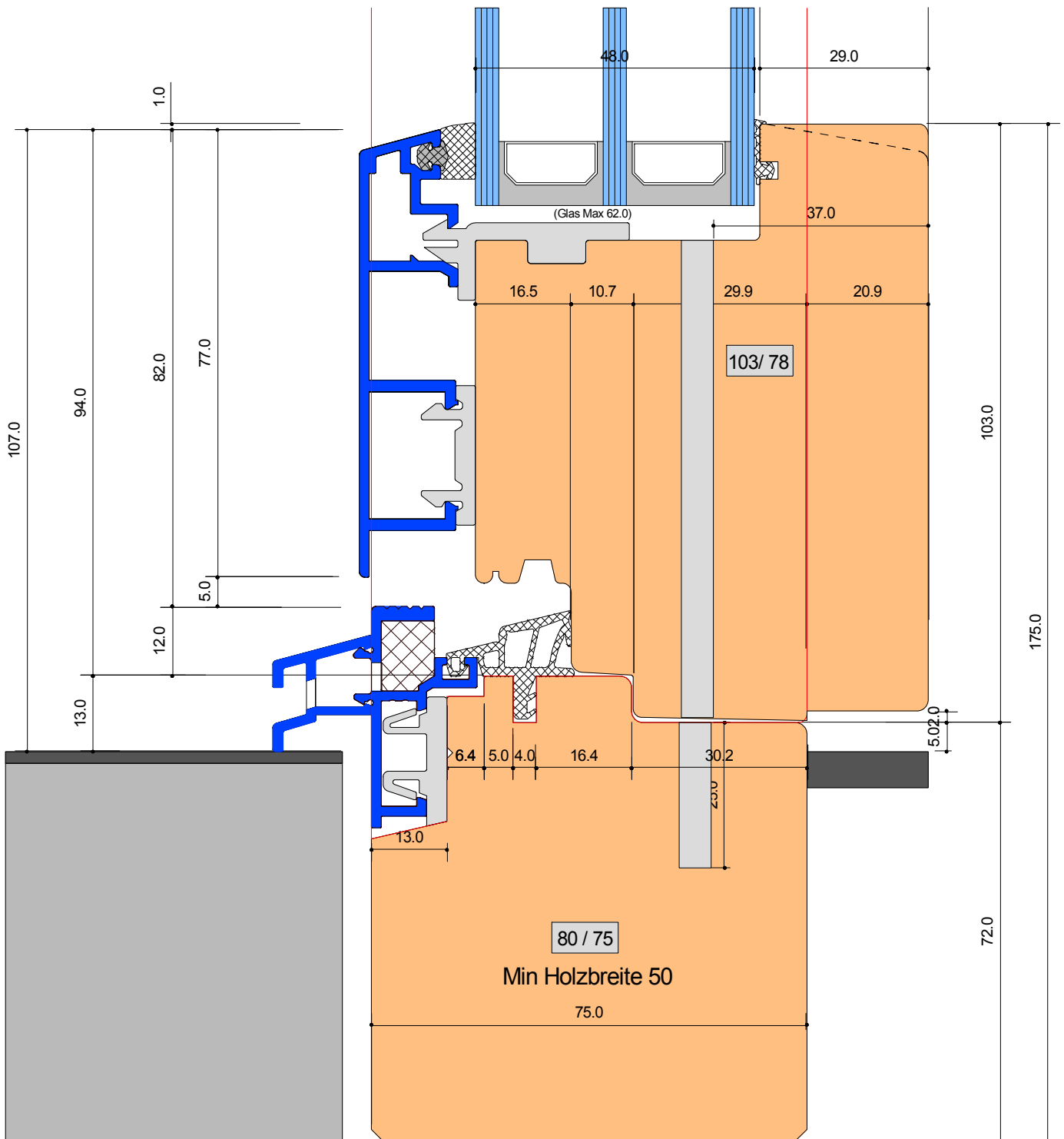

SYSTEM: M-4 75-78

Anschluss unten Rollstuhlgängig
 Mit Flügelbreite 103 (-6.0mm) Fest vergl. v. aussen
 Grundprofil M1-GR 038-18 Roll / Steckteil Variabel

Detail-Nr : M - 4 D=046



Von Euw Fenster AG
 Schoosstrasse 2
 6418 Rothenthurm

Tel 041 839 80 50
 Fax 041 839 80 60
 mail info@voneuw.ch

Ersteller: Adi von Euw
 Datum: 22.02.16
 Revidiert: 05.11.19

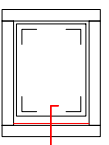

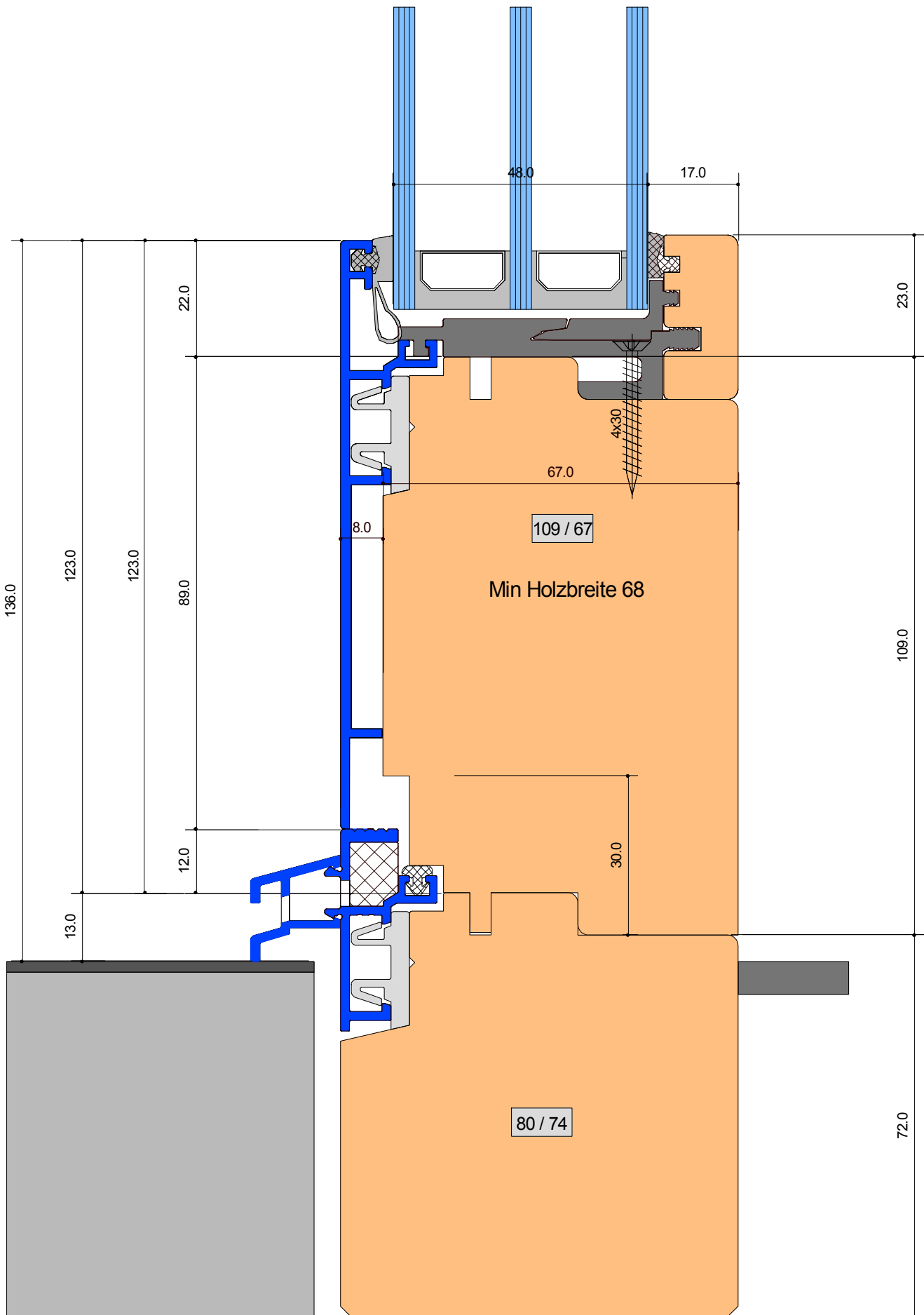

SYSTEM: M-4 74-78

passend zu Haustüre unten mit Fries 130 mm
 Fest i.R. verglast mit Einleimer/ passend zu HT Fr 130 mm
 Grundprofil M1-GR 038-18 Roll / Steckteil Variabel

Detail-Nr :	M -4	D=047
-------------	------	-------



Von Euw Fenster AG
 Schoosstrasse 2
 6418 Rothenthurm

Tel 041 839 80 50
 Fax 041 839 80 60
 mail info@voneuw.ch

Ersteller: Adi von Euw
 Datum: 28.08.17
 Revidiert: 05.11.19

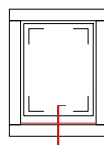

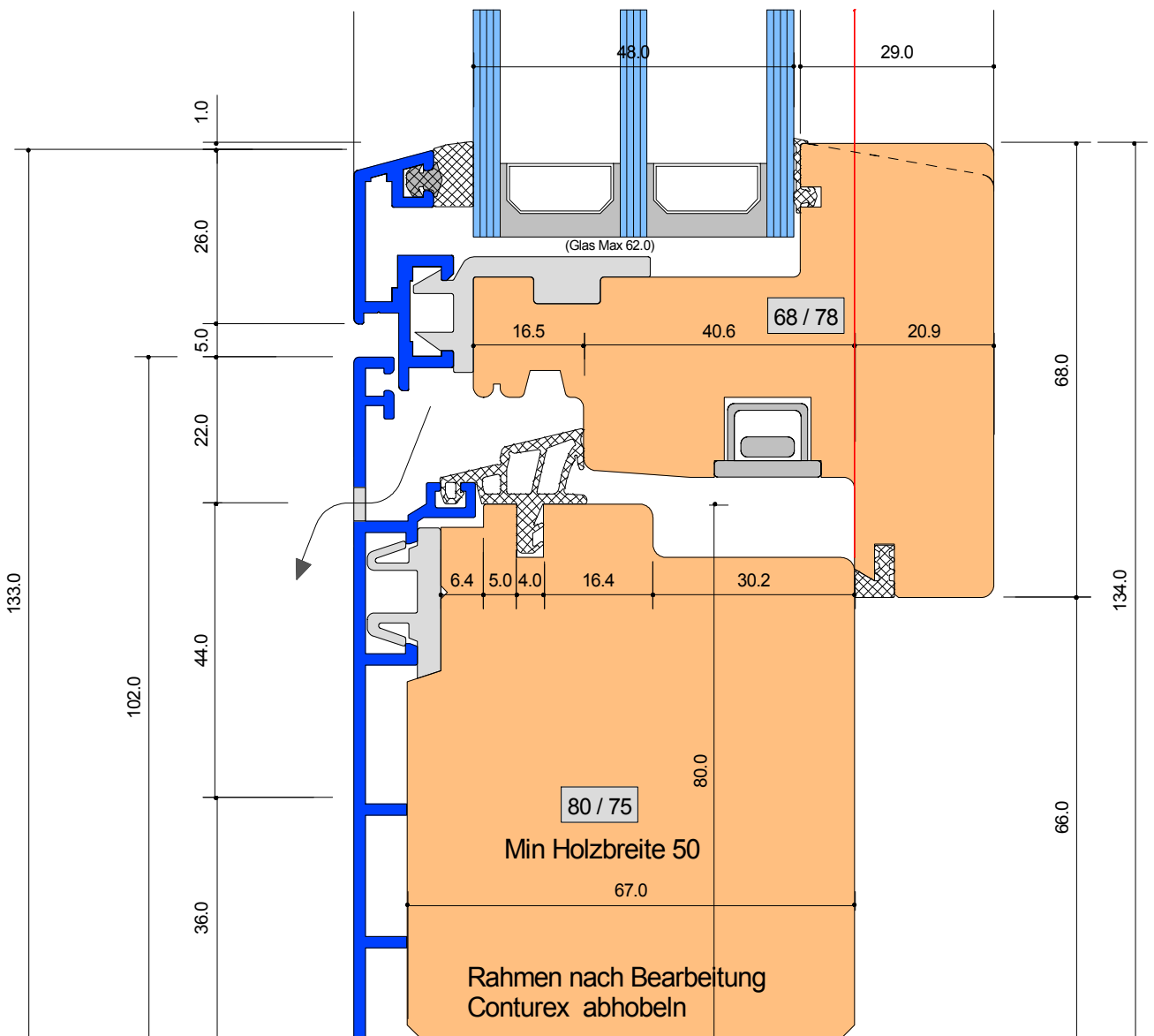

SYSTEM: M-4 75-78

Blockrahmen (mit oder ohne WS) Mit Alu (113 mm)

Detail-Nr :	M - 4	D=051
-------------	-------	-------



Von Euw Fenster AG
Schoosstrasse 2
6418 Rothenthurm

Tel 041 839 80 50
Fax 041 839 80 60
mail info@voneuw.ch

Ersteller: Adi von Euw
Datum: 22.02.16
Revidiert:

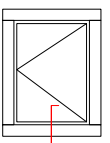

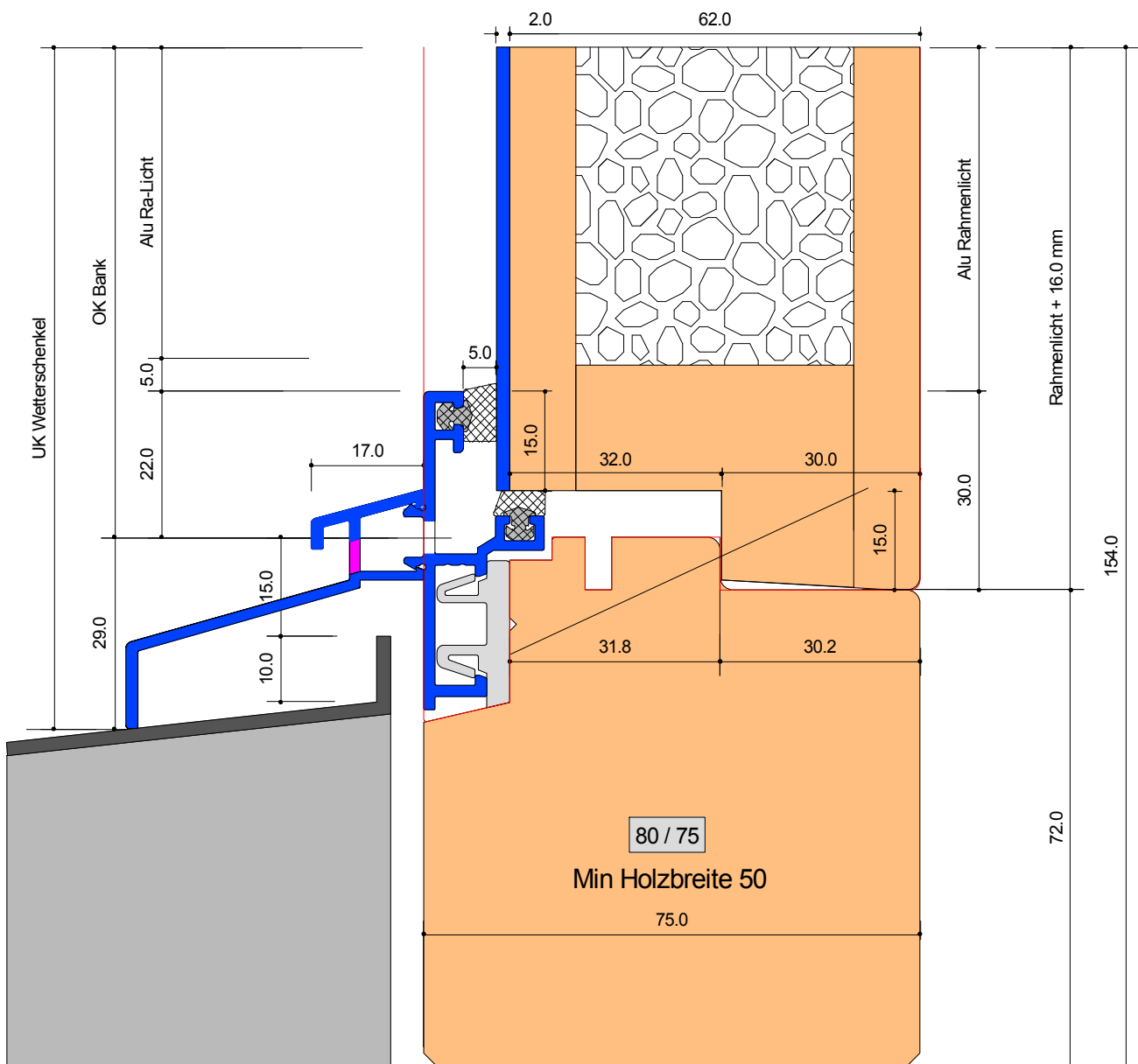

SYSTEM: M-4 75-78

Anschluss unten mit Alu Fensterbank
 Wetterschenkel Typ RWS 045-013
 mit Brüstungseinsatz innen FI-bündig

Detail-Nr :	M - 4	D=060
-------------	-------	-------



Von Euw Fenster AG
 Schoosstrasse 2
 6418 Rothenthurm

Tel 041 839 80 50
 Fax 041 839 80 60
 mail info@voneuw.ch

Ersteller: Adi von Euw
 Datum: 22.02.16
 Revidiert: 23.01.19

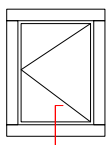

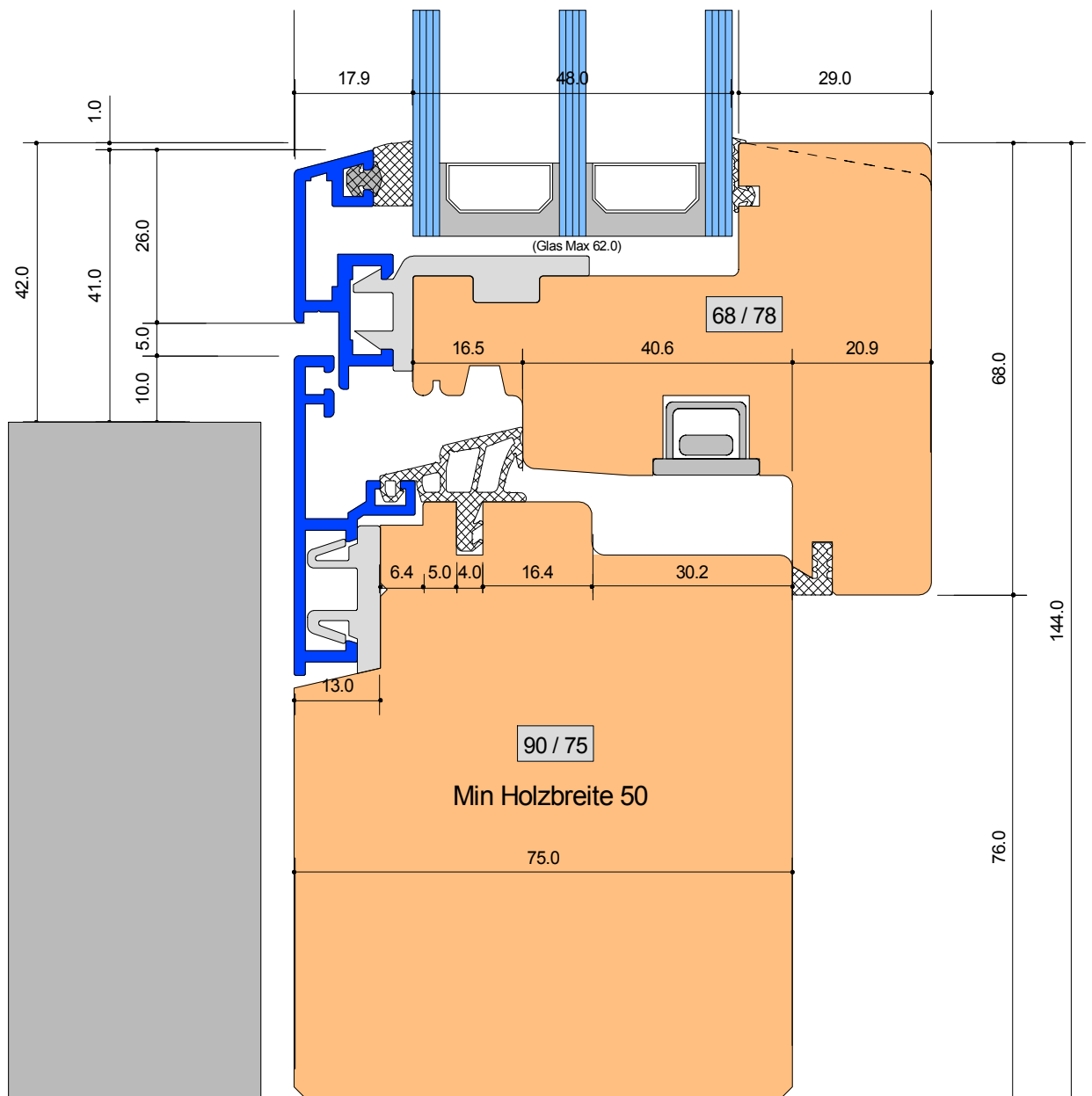

SYSTEM: M-4 75-78

Anschluss seitlich Standart Flg 68

Detail-Nr : M - 4 D=201



Von Euw Fenster AG
Schoosstrasse 2
6418 Rothenthurm

Tel 041 839 80 50
Fax 041 839 80 60
mail info@voneuw.ch

Ersteller: Adi von Euw
Datum: 22.02.16
Revidiert:

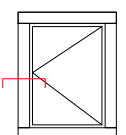

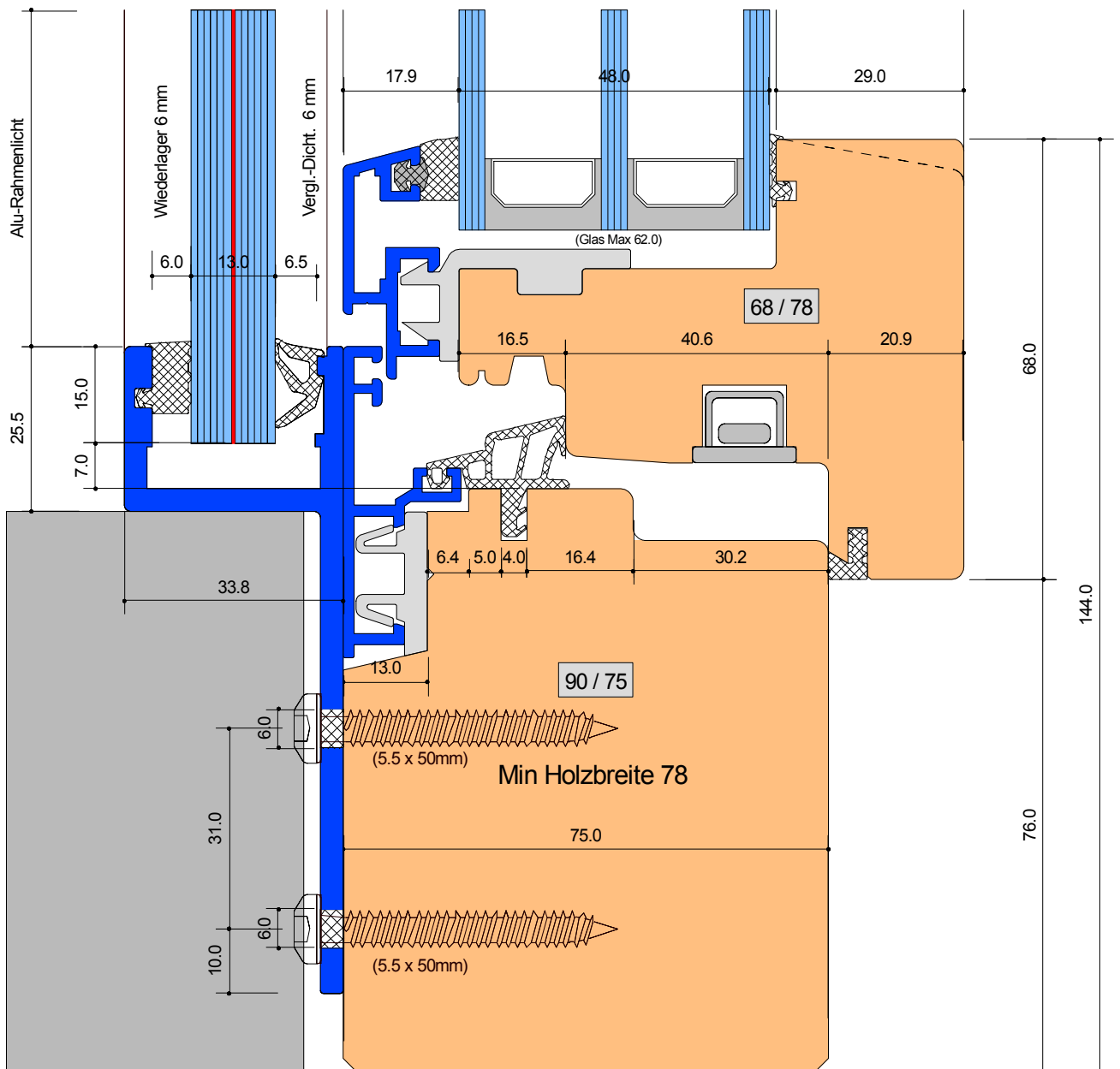

SYSTEM: M-4 75-78

Anschluss seitlich Standart Flg 68
mit Brüstungsglas VSG 12-2,
bis Glasbreite ca 1000 mm

Detail-Nr : M - 4 D=201G



Von Euw Fenster AG
Schoosstrasse 2
6418 Rothenthurm

Tel 041 839 80 50
Fax 041 839 80 60
mail info@voneuw.ch

Ersteller: Adi von Euw
Datum: 27.03.17
Revidiert:

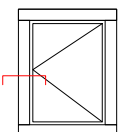

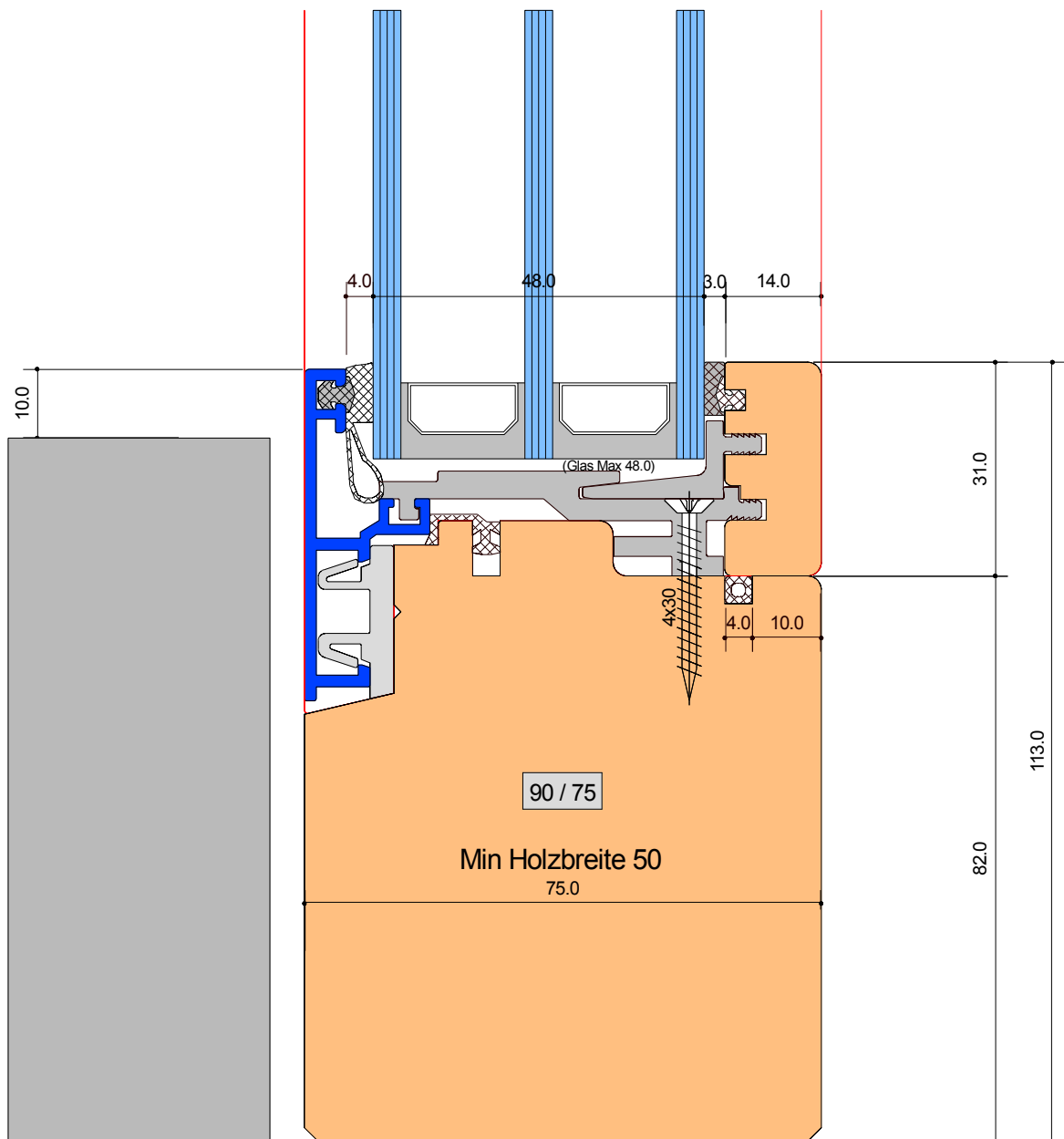

SYSTEM: M-4 75-78

Fest i.R. verglast

Detail-Nr :	M - 4	D=201R
-------------	-------	--------

Ersteller: Adi von Euw
 Datum: 23.11.16
 Revidiert:



Von Euw Fenster AG
 Schoosstrasse 2
 6418 Rothenthurm

Tel 041 839 80 50
 Fax 041 839 80 60
 mail info@voneuw.ch

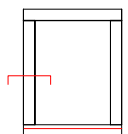

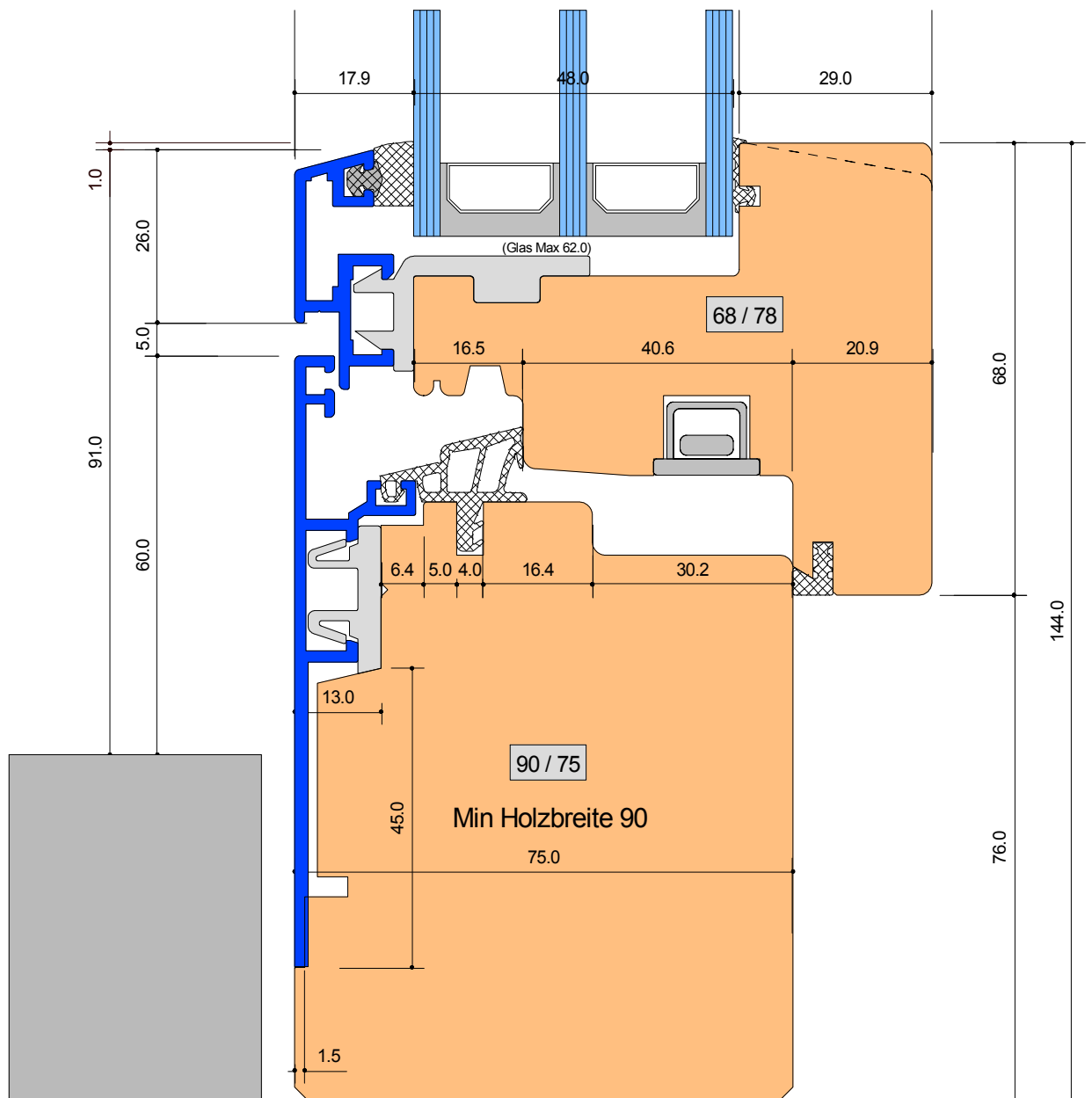

SYSTEM: M-4 75-78

Anschluss seitlich Standart Fig 68
 mit breitem Profil für mehr ins Licht stehend

Detail-Nr : M - 4 D=201Z



Von Euw Fenster AG
 Schoosstrasse 2
 6418 Rothenthurm

Tel 041 839 80 50
 Fax 041 839 80 60
 mail info@voneuw.ch

Ersteller: Adi von Euw
 Datum: 22.02.16
 Revidiert:

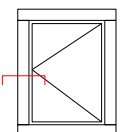

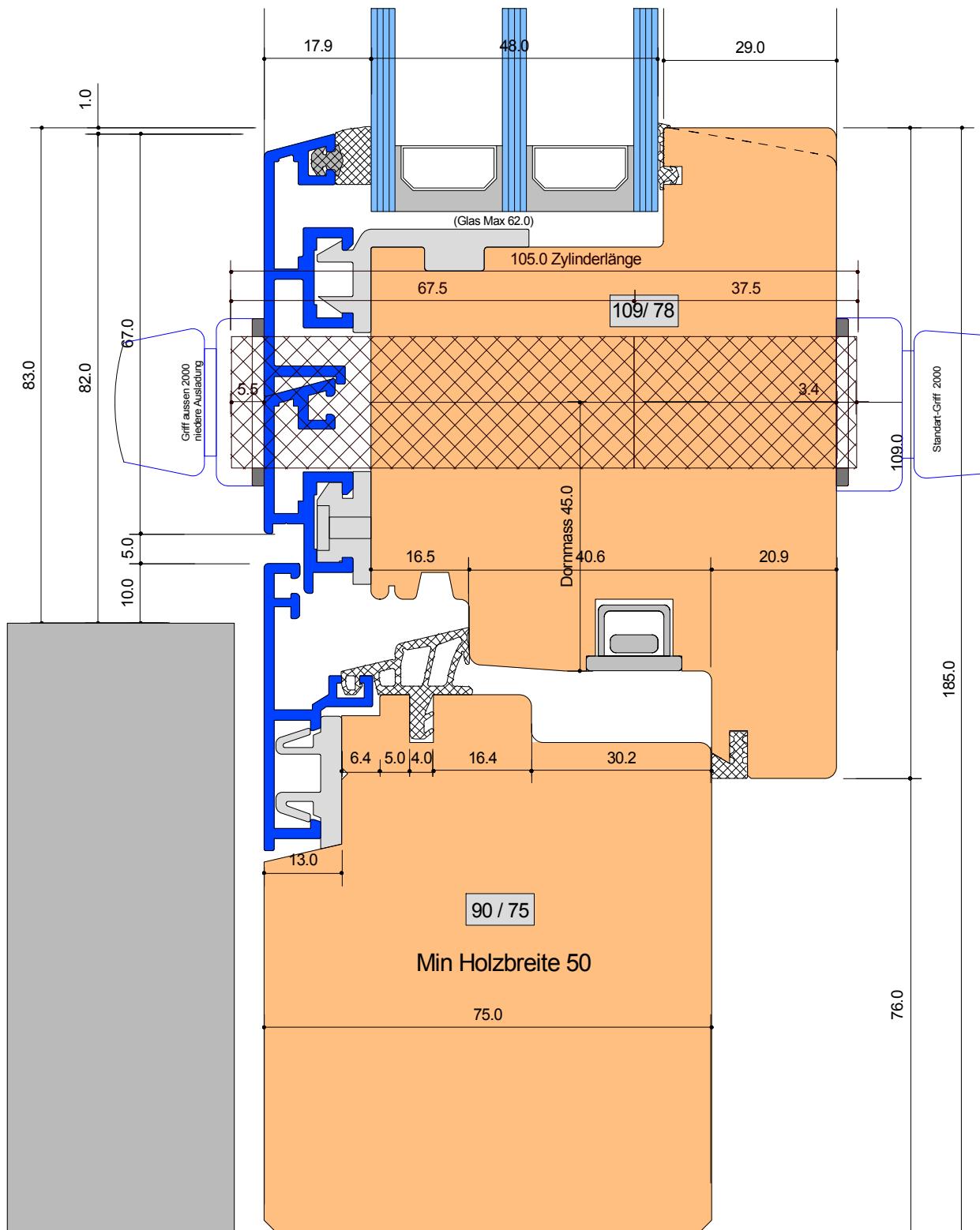

SYSTEM: M-4 75-78

Anschluss seitlich Standart Fig 109 mm
 Verschluss durchg. D=45.0 mm Griff m.Knopf/Schlüssel
 Variante: Verschluss durchg. D=45.0 mm mit Zylinder

Detail-Nr : M - 4 D=205



Von Euw Fenster AG
 Von Euw Fenster AG
 Schoosstrasse 2
 6418 Rothenthurm

Tel 041 839 80 50
 Fax 041 839 80 60
 mail info@voneuw.ch

Ersteller: Adi von Euw
 Datum: 16.06.16
 Revidiert:

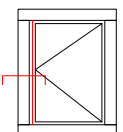

Variante 1
 Schutzschild Glutz
 ES1 5430S mit Zyl.
 Schutzrosette (10-14 mm)

Variante 2
 Rund-Schutzrosette Glutz
 ES1 5330.2S-RS mit Schutz-
 Einsatz (7-12 einwärts)

Variante 1
 Innenschild Glutz
 ES1 5435C.2 gerade

Variante 2
 Rund-Rosette innen Glutz
 5330.C mit Grundplatte

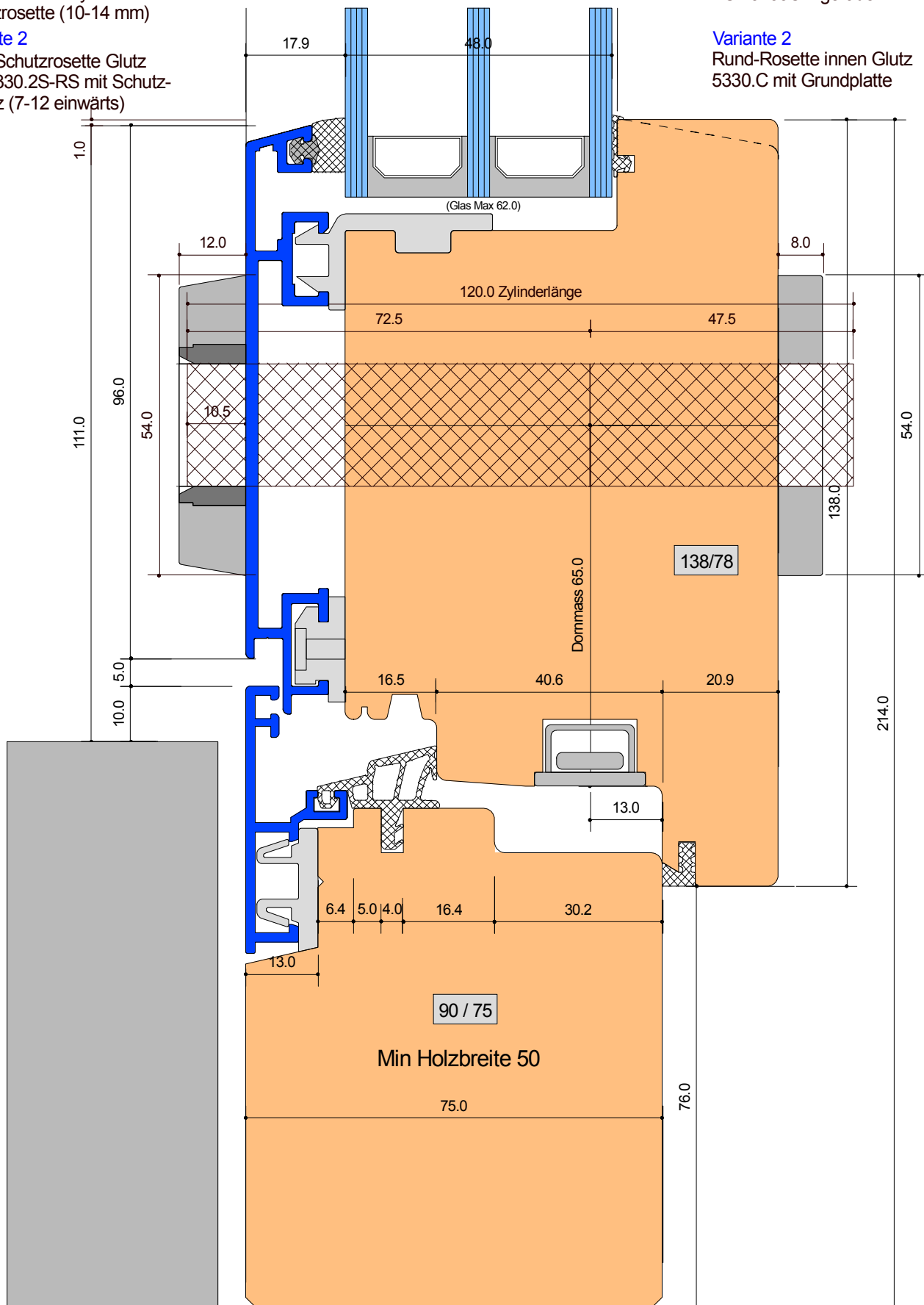

SYSTEM: M-4 75-78

Anschluss seitlich mit Flügel 138 mm
 mit Haustürverschluss D=65 mm
 mit Sicherheitslängschild Glutz 5430S/5435C.2
 mit Rund-Ros Glutz ES1 5330.2S-RS/5330C

Detail-Nr : M - 4 D=210



Von Euw Fenster AG
 Schoosstrasse 2
 6418 Rothenthurm

Tel 041 839 80 50
 Fax 041 839 80 60
 mail info@voneuw.ch

Ersteller: Adi von Euw
 Datum: 15.06.16
 Revidiert:

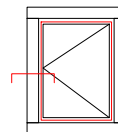

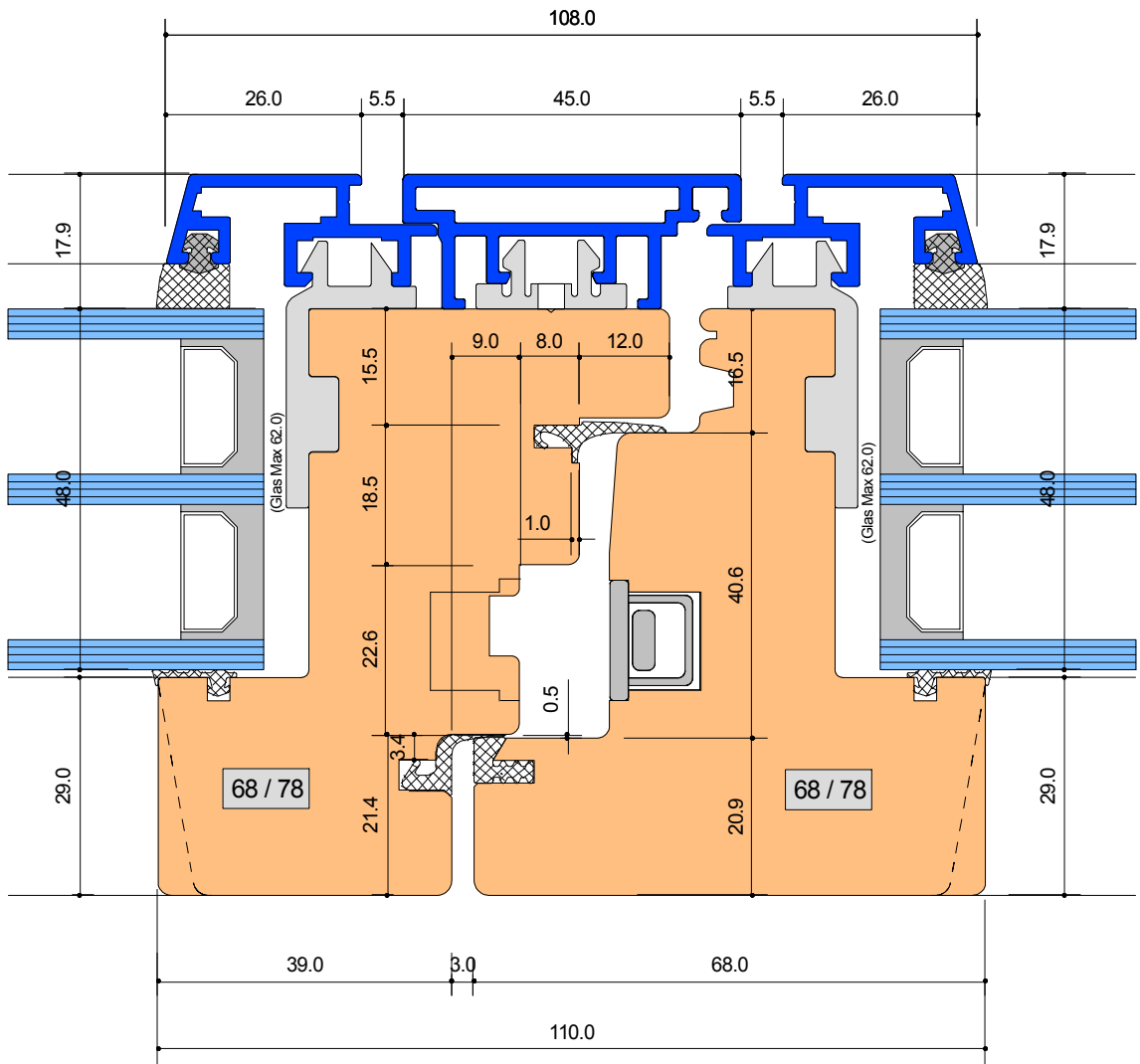

SYSTEM: M-4 75-78

Mittelpartie Standart 2 x Flg 68

Detail-Nr :	M - 4	D=301
-------------	-------	-------

Ersteller: Adi von Euw
 Datum: 22.02.16
 Revidiert: 24.10.19



Von Euw Fenster AG
 Schoosstrasse 2
 6418 Rothenthurm

Tel 041 839 80 50
 Fax 041 839 80 60
 mail info@voneuw.ch

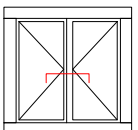

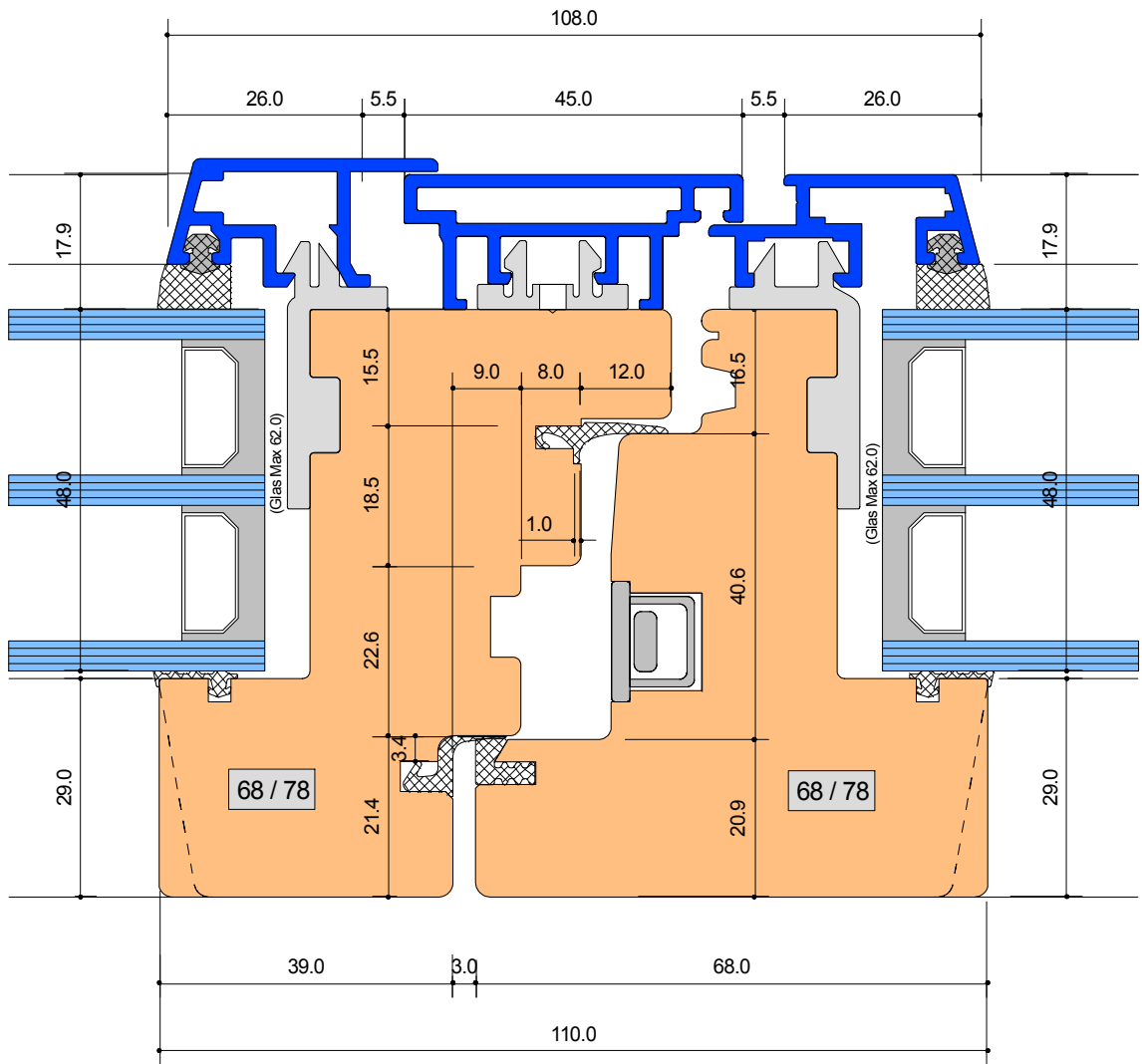

SYSTEM: M-4 75-78

Mittelpartie einseitig mit fest vergl. Flg v. aussen

Detail-Nr :	M - 4	D=310
-------------	-------	-------



Von Euw Fenster AG
Schoosstrasse 2
6418 Rothenthurm

Tel 041 839 80 50
Fax 041 839 80 60
mail info@voneuw.ch

Ersteller: Adi von Euw
Datum: 22.02.16
Revidiert: 24.10.19

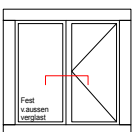

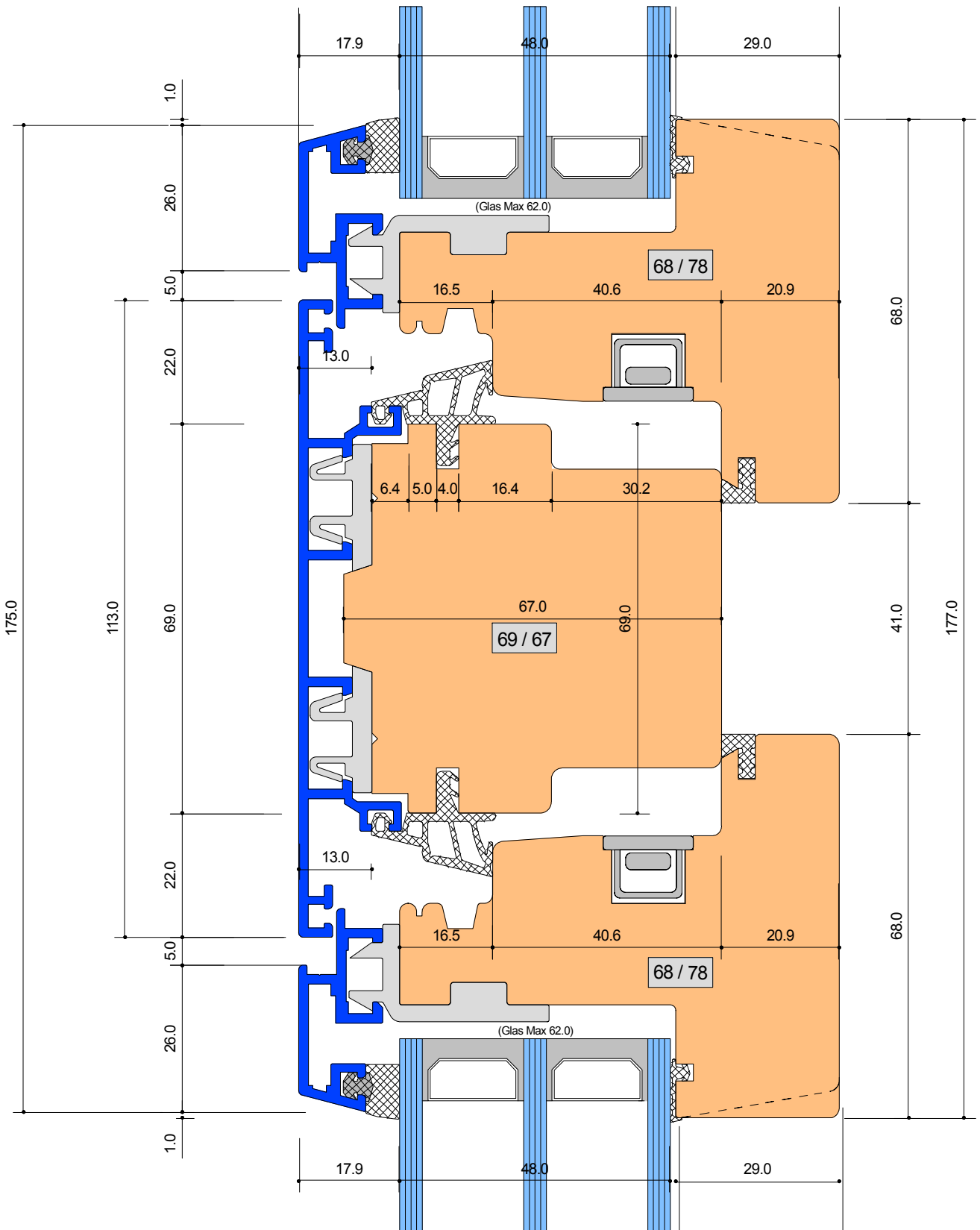

SYSTEM: M-4 75-78

Kämpfer und Setzholz Alu 113 mm

Detail-Nr :	M - 4	D=401
-------------	-------	-------

Ersteller: Adi von Euw
 Datum: 22.02.16
 Revidiert:



Von Euw Fenster AG
 Schoosstrasse 2
 6418 Rothenthurm

Tel 041 839 80 50
 Fax 041 839 80 60
 mail info@voneuw.ch

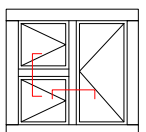

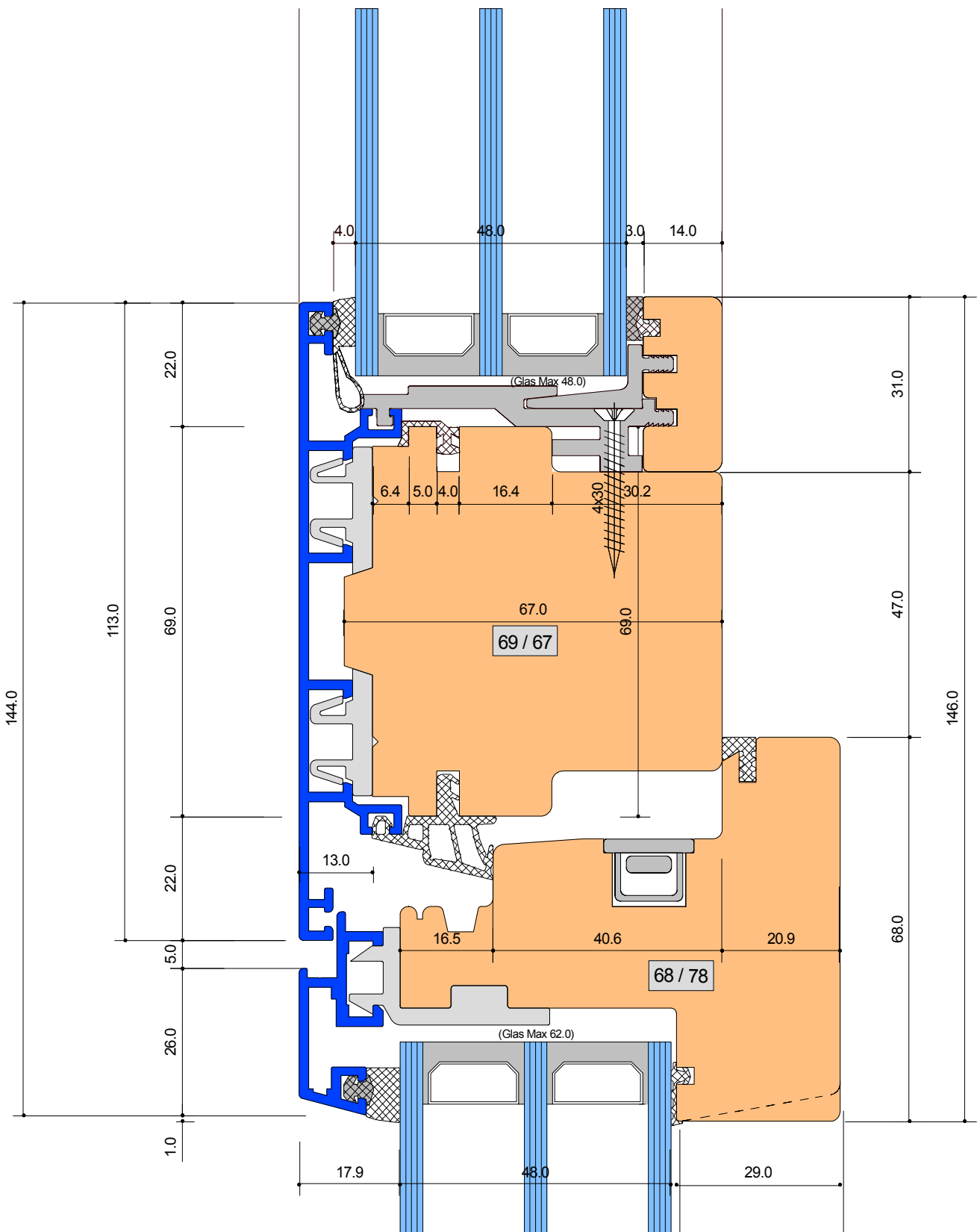

SYSTEM: M-4 75-78

Kämpfer und Setzholz Alu 113 mm
einseitig mit fest i.R. verglast

Detail-Nr : M - 4 D=401R



Von Euw Fenster AG
Schoosstrasse 2
6418 Rothenthurm

Tel 041 839 80 50
Fax 041 839 80 60

mail info@voneuw.ch

Ersteller: Adi von Euw
Datum: 23.11.16
Revidiert:

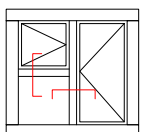

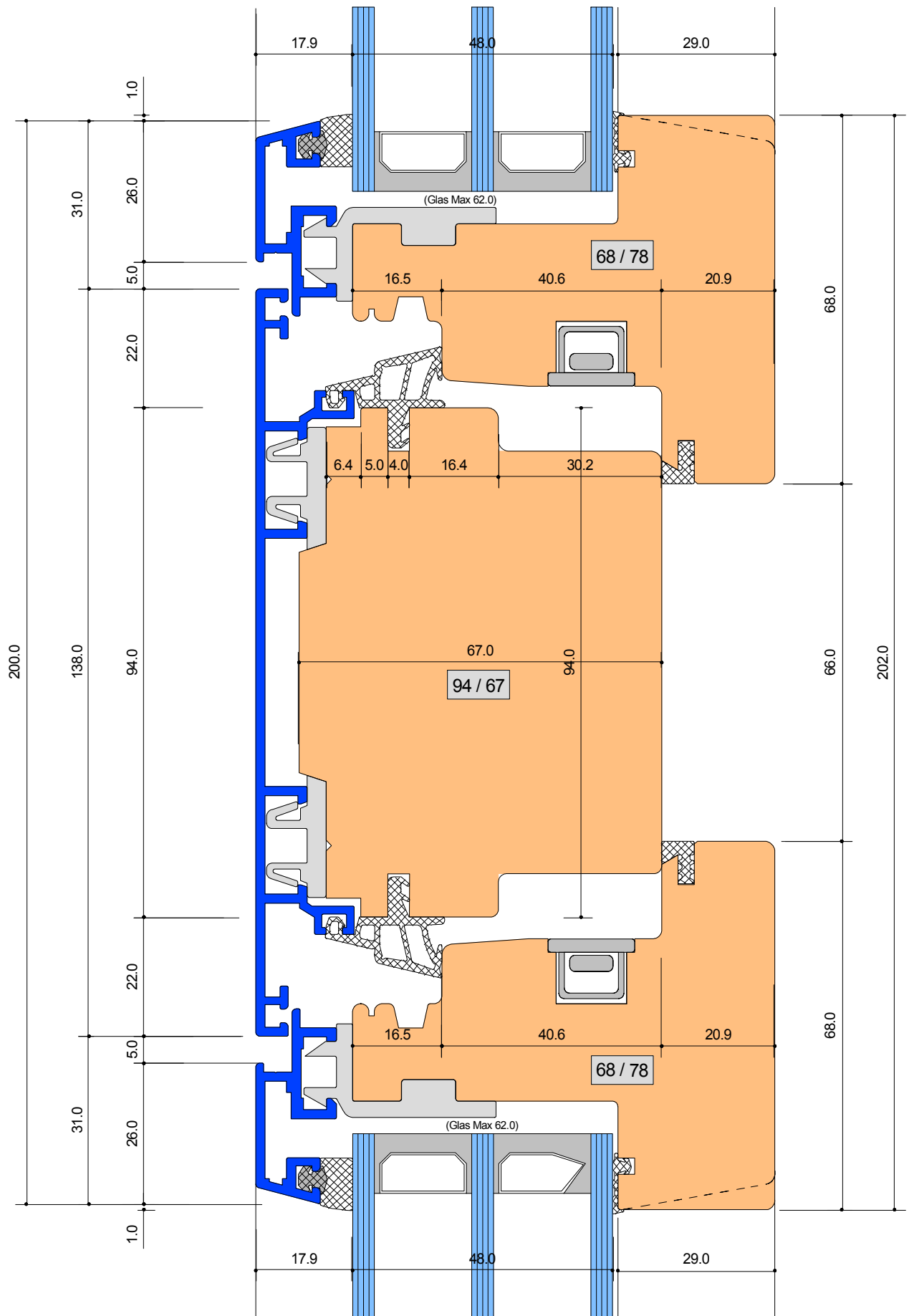

SYSTEM: M-4 75-78

Kämpfer und Setzholz Alu 138 mm

Detail-Nr : M - 4 D=402

Ersteller: Adi von Euw
Datum: 22.02.16
Revidiert:



Von Euw Fenster AG
Schoosstrasse 2
6418 Rothenthurm

Tel 041 839 80 50
Fax 041 839 80 60
mail info@voneuw.ch

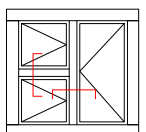

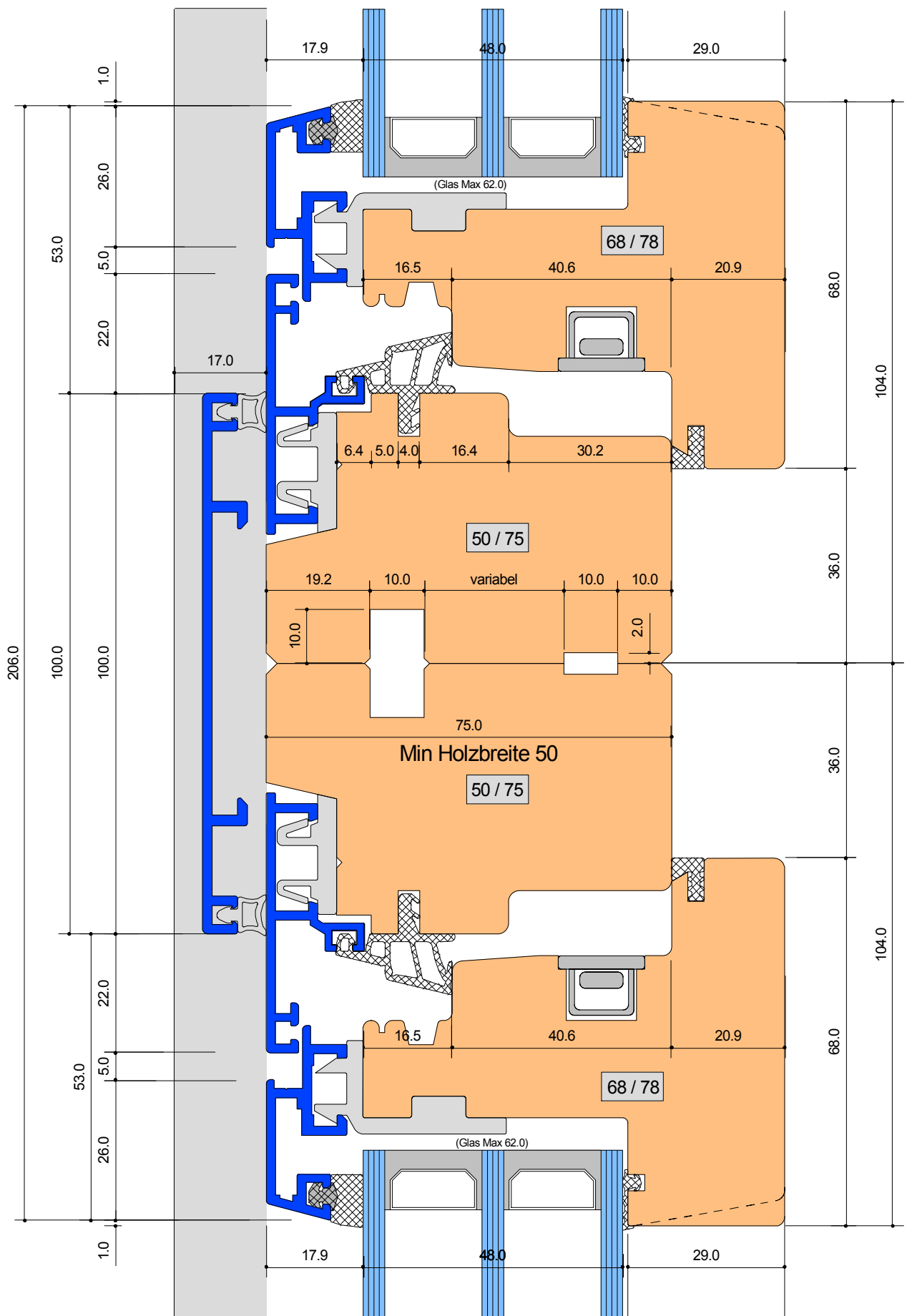

SYSTEM: M-4 75-78

Kombinationszusammenbau mit Nut + Feder

Detail-Nr : M - 4 D=405

Ersteller: Adi von Euw
Datum: 22.02.16
Revidiert:



Von Euw Fenster AG
Schoosstrasse 2
6418 Rothenthurm

Tel 041 839 80 50
Fax 041 839 80 60
mail info@voneuw.ch

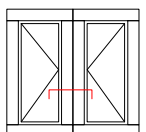

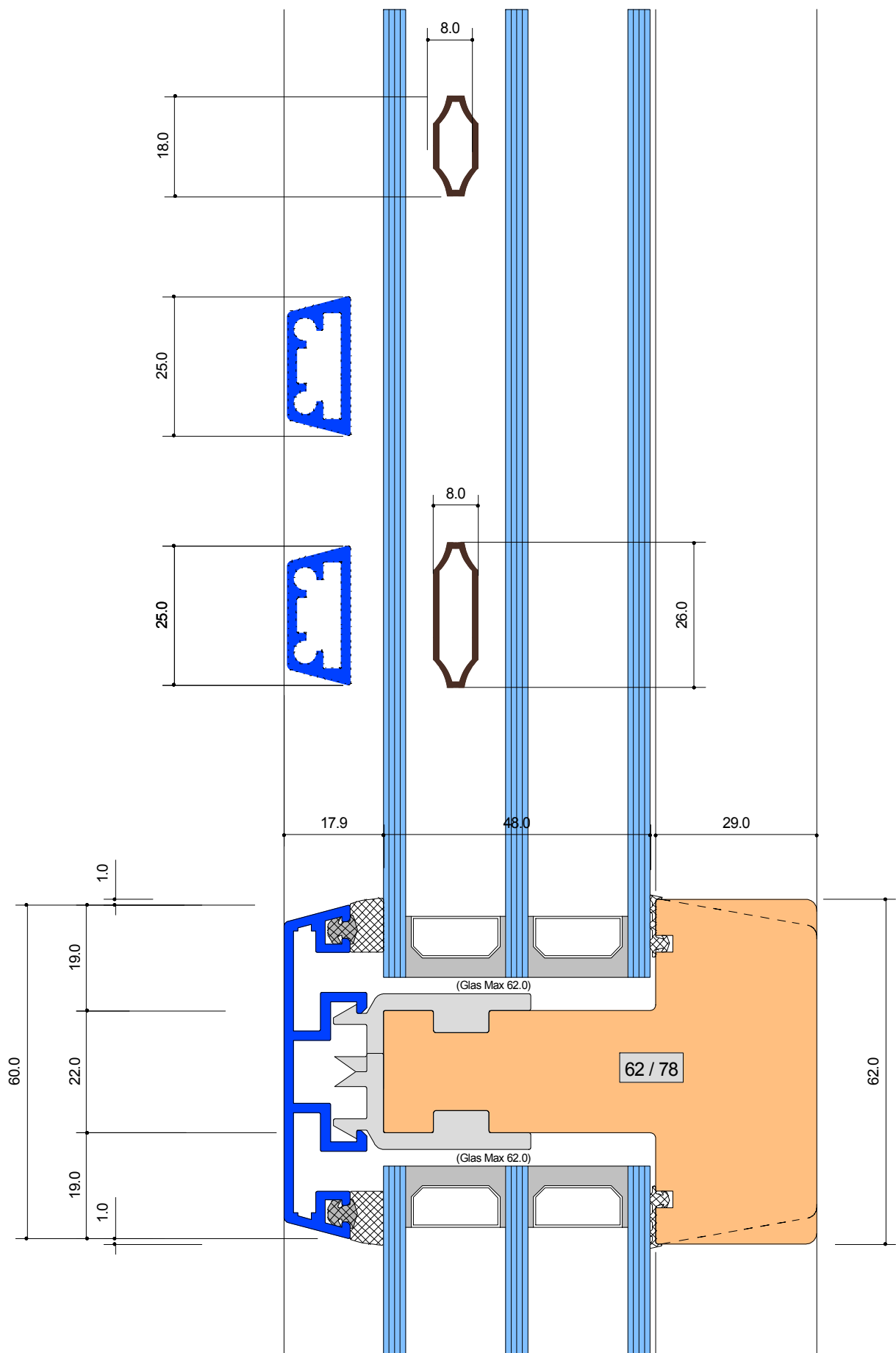

SYSTEM: M-4 75-78

Sprossen glastrennend 62 mm Alu 60 mm
 Vorgesetzte Alu-Spr. 25 mm +Zw.Glas Sprosse 26 mm
 Vorgesetzte Alu-Spr. 25 mm
 Zwischenglas -Sprosse 18 mm

Detail-Nr : M - 4 D=601



Von Euw Fenster AG
 Schoosstrasse 2
 6418 Rothenthurm

Tel 041 839 80 50
 Fax 041 839 80 60
 mail info@voneuw.ch

Ersteller: Adi von Euw
 Datum: 22.02.16
 Revidiert:

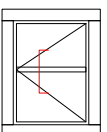

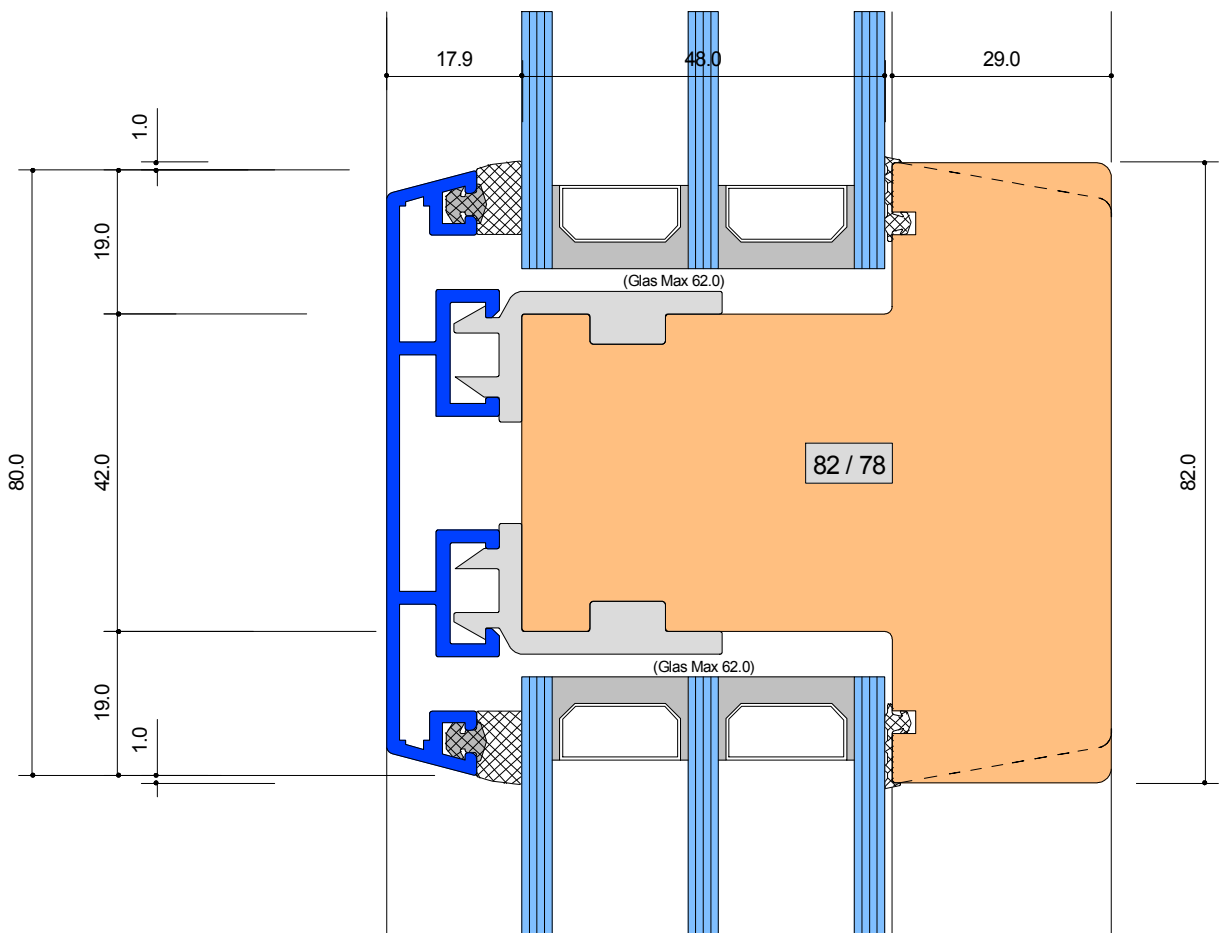

SYSTEM: M-4 75-78

Sprossen glastrennend 80 mm

Detail-Nr :	M - 4	D=602
-------------	-------	-------



Von Euw Fenster AG
Schoosstrasse 2
6418 Rothenthurm

Tel 041 839 80 50
Fax 041 839 80 60
mail info@voneuw.ch

Ersteller: Adi von Euw
Datum: 22.02.16
Revidiert:

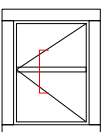

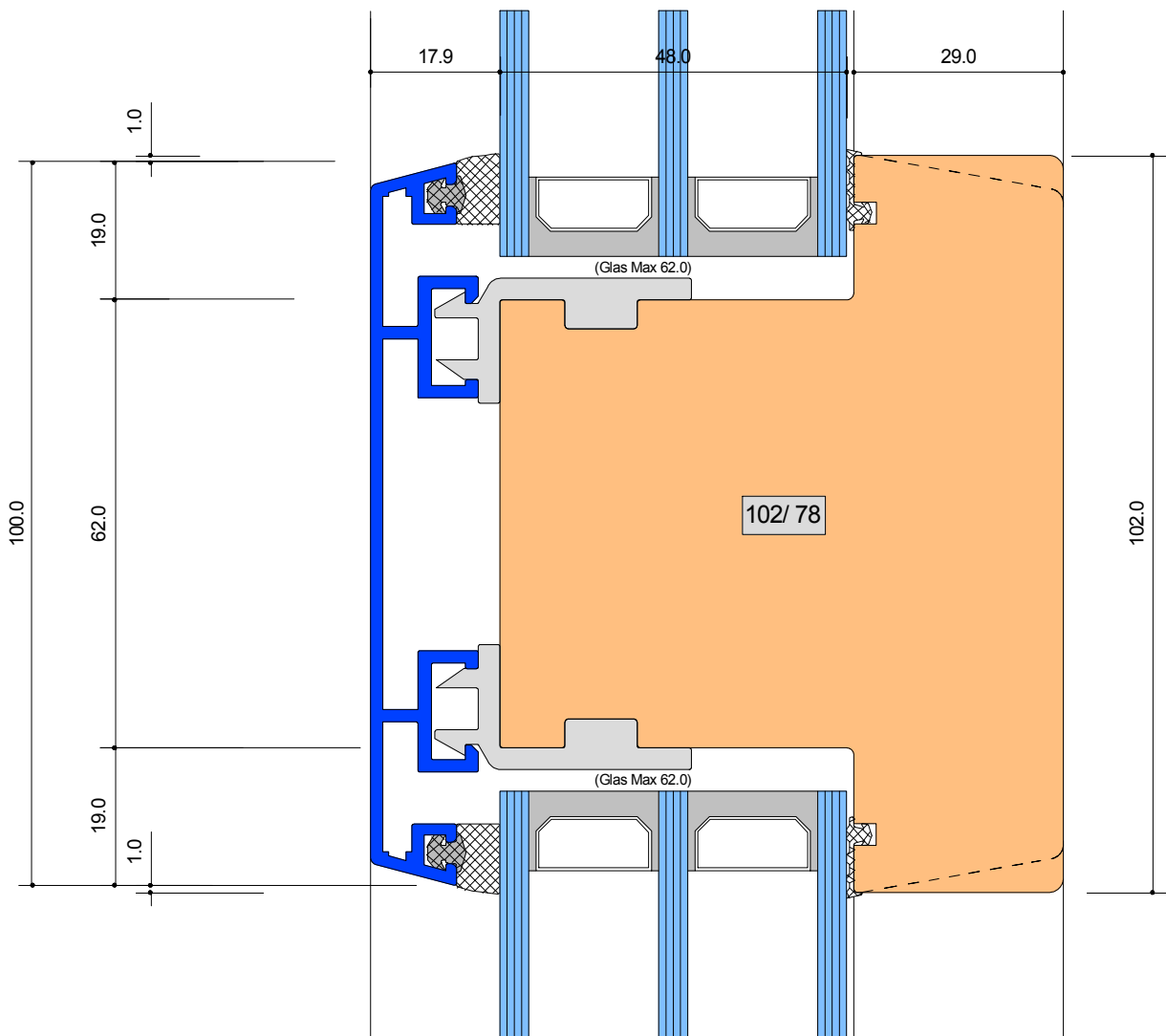

SYSTEM: M-4 75-78

Sprossen glastrennend 100 mm

Detail-Nr :	M - 4	D=603
-------------	-------	-------



Von Euw Fenster AG
Schoosstrasse 2
6418 Rothenthurm

Tel 041 839 80 50
Fax 041 839 80 60
mail info@voneuw.ch

Ersteller: Adi von Euw
Datum: 22.02.16
Revidiert:

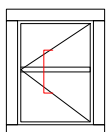

N69202 0.353 g/m1
 X1-ST 045-008 (roh+eloxiert)
 Fräsung 30.0 x 5.0 mm
 Abstand 125/25x250/125

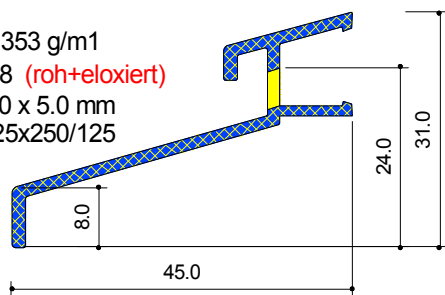

N74777 0.378 g/m1
 X1-ST 045-013 (roh+eloxiert)
 Fräsung 30.0 x 5.0 mm
 Abstand 125/25x250/125

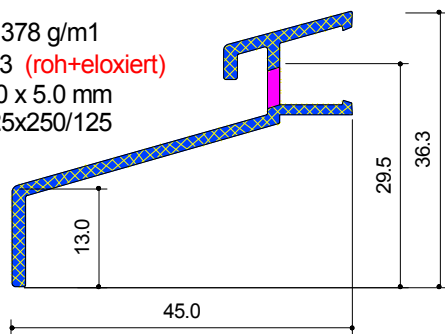

N70586 0.445 g/m1
 X1-ST 065-008 (roh+eloxiert)
 Fräsung 30.0 x 5.0 mm
 Abstand 125/25x250/125

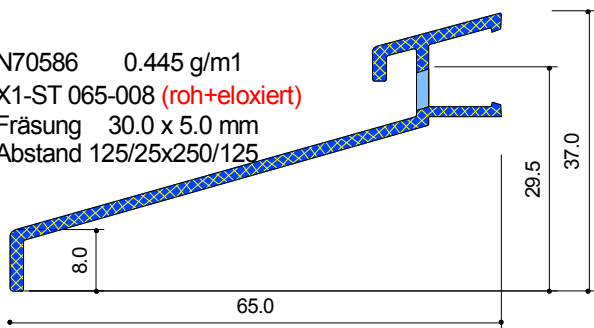

N74260 0.561 g/m1
 X1-ST 065-030 (eloxiert)
 Fräsung 30.0 x 5.0 mm
 Abstand 125/25x250/125

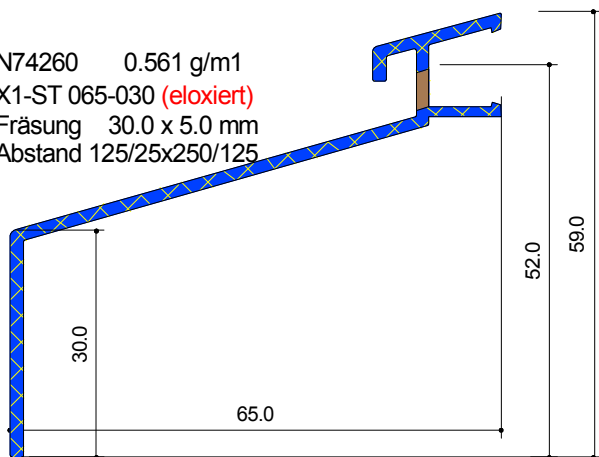

N70584 0.295 g/m1
 X1-ST 017-021 (eloxiert)
 Fräsung 30.0 x 5.0 mm
 Abstand 125/25x250/125

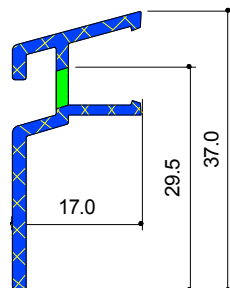

N70585 0.393 g/m1
 X1-ST 017-041 (eloxiert)
 Fräsung 30.0 x 5.0 mm
 Abstand 125/25x250/125

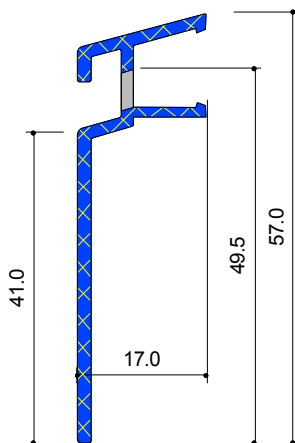

N74261 0.620 g/m1
 X1-ST 017-084 (eloxiert)
 Fräsung 30.0 x 5.0 mm
 Abstand 125/25x250/125

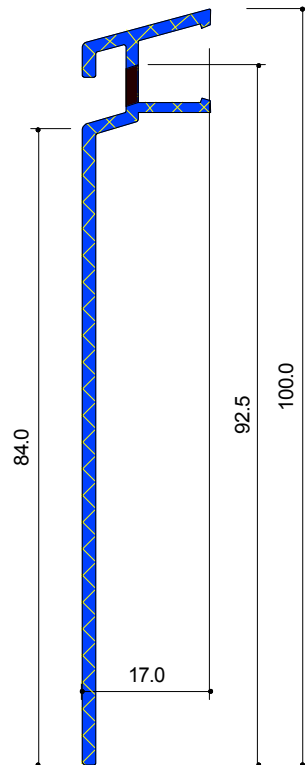

L49108 0.450 g/m1
 M1-GR 038-18 Roll (roh)
 Fräsung 30.0 x 5.0 mm
 Abstand 50/32x200/50

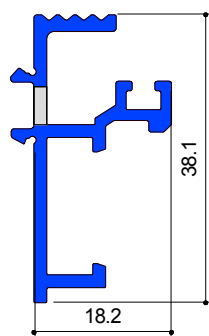

SYSTEM: *H, L, M, R*

Steckteil-Profilübersicht

Detail-Nr : A-1 D=100



Von Euw Fenster AG
 Schoosstrasse 2
 6418 Rothenthurm

Tel 041 839 80 50
 Fax 041 839 80 60
 mail info@voneuw.ch

Ersteller: Adi von Euw
 Datum: 28.03.17

- Alu *roh* (Lager)
- Alu *farblos elox.* (Lager)
- Alu *Roh + farblos elox.* (Lager)