

# Holz-Metallfenster

System : M-3 71/74 „top class“

## Vermasste Standard-Details

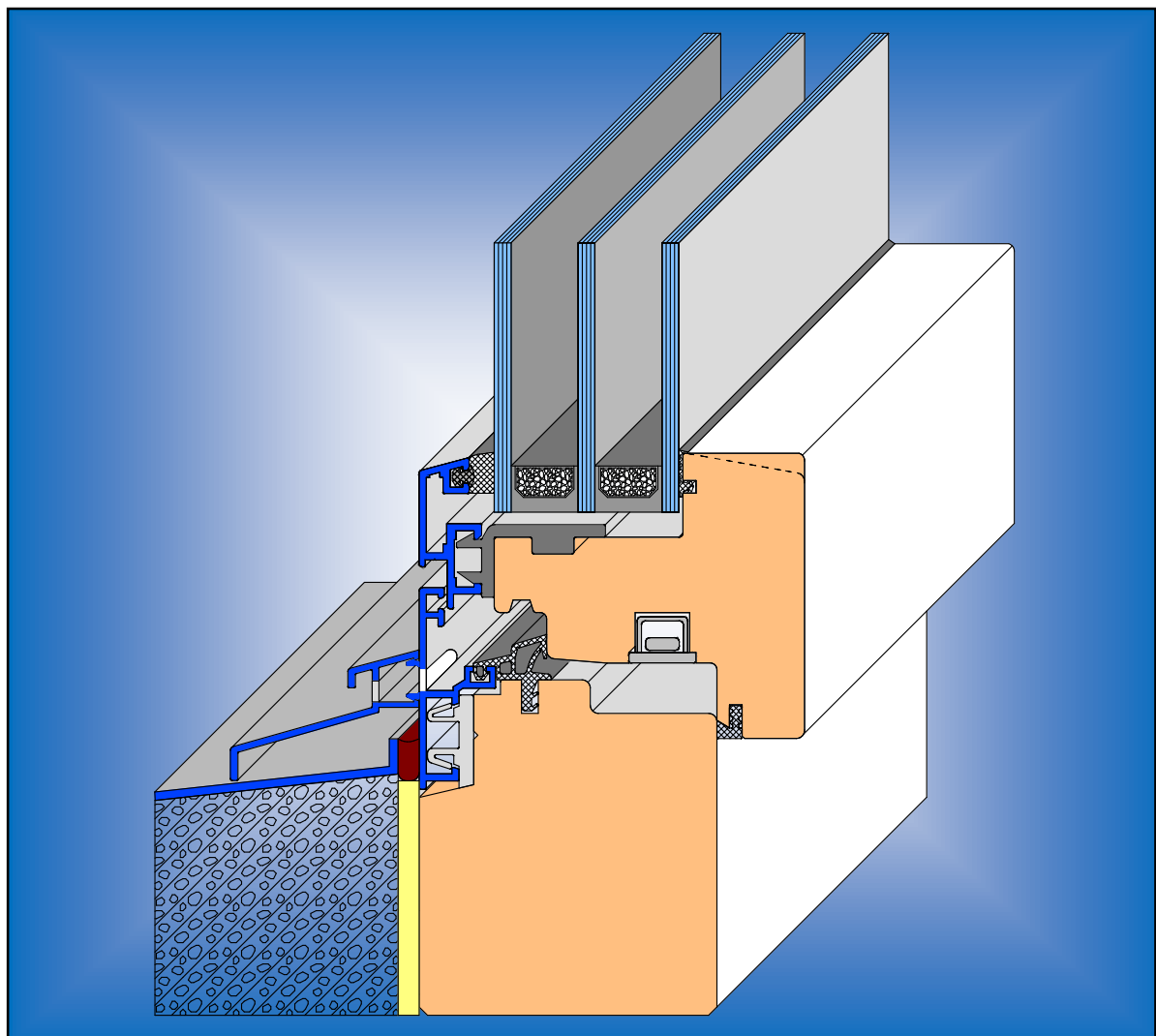

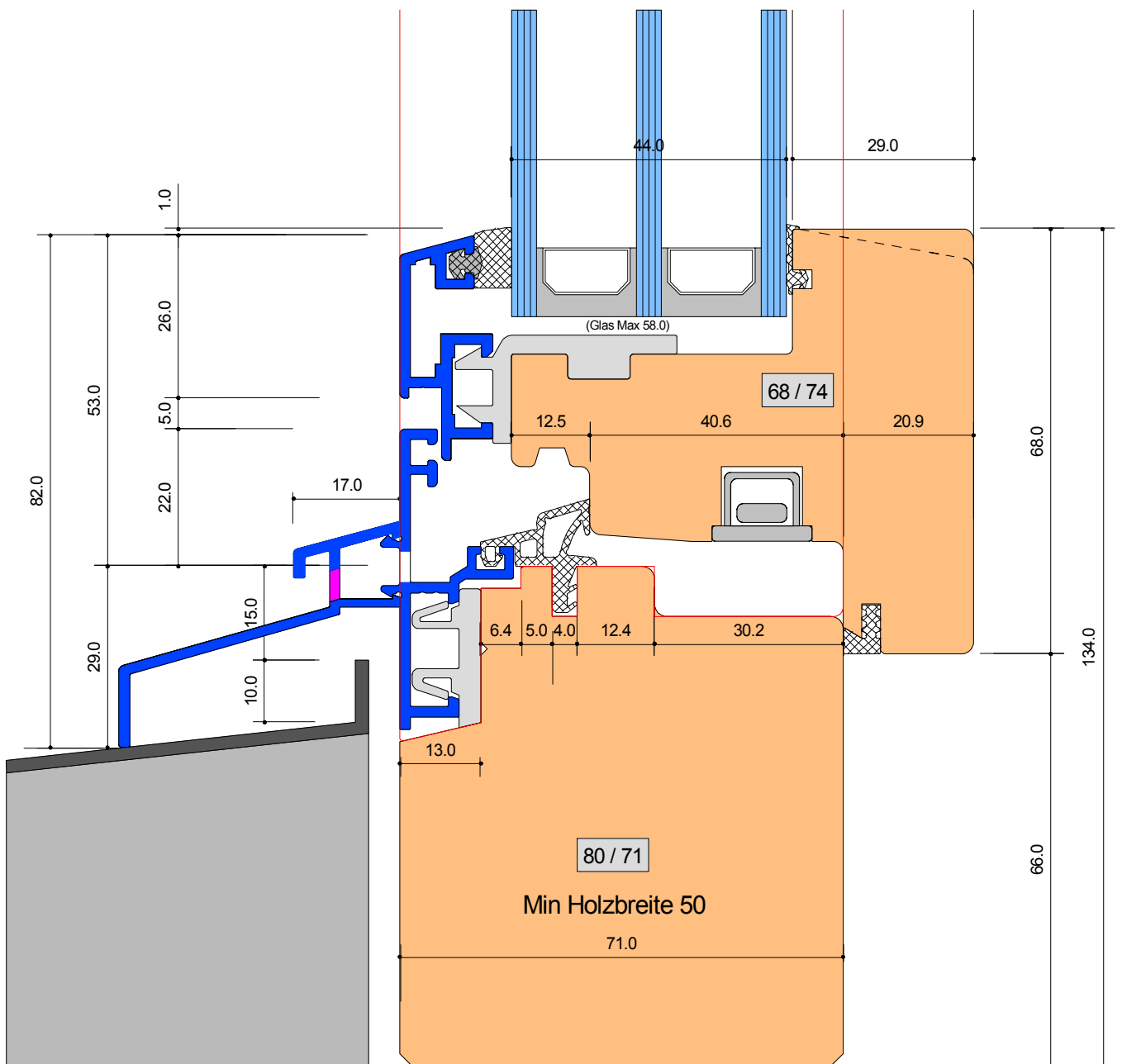

**SYSTEM: M-3 71-74**

Anschluss unten mit Alu Fensterbank  
Wetterschenkel Typ RWS 045-013

Detail-Nr :	M -3	D=001
-------------	------	-------



Von Euw Fenster AG  
Schoosstrasse 2  
6418 Rothenthurm

Tel 041 839 80 50  
Fax 041 839 80 60  
mail info@voneuw.ch

Ersteller: Adi von Euw  
Datum: 26.10.15  
Revidiert:

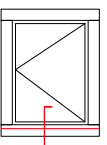

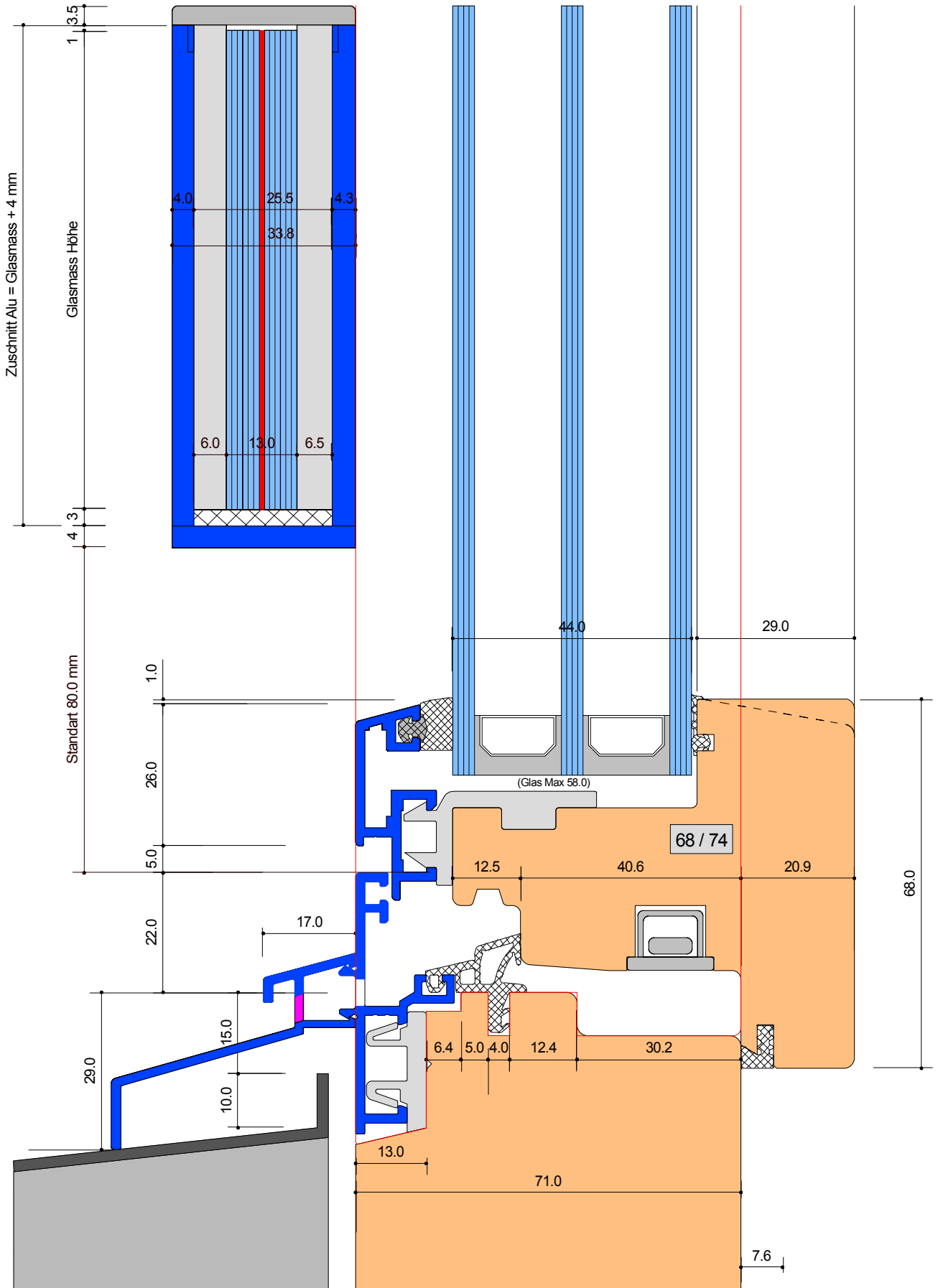

## SYSTEM: M-3 71-74

Anschluss unten mit Alu Fensterbank  
 Wetterschenkel Typ RWS 045-013  
 mit Brüstungsglas VSG 12-2

Detail-Nr : M-3 D=001G



Von Euw Fenster AG  
 Schoosstrasse 2  
 6418 Rothenthurm

Tel 041 839 80 50  
 Fax 041 839 80 60  
 mail info@voneuw.ch

Ersteller: Adi von Euw  
 Datum: 27.03.17  
 Revidiert:

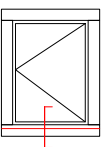

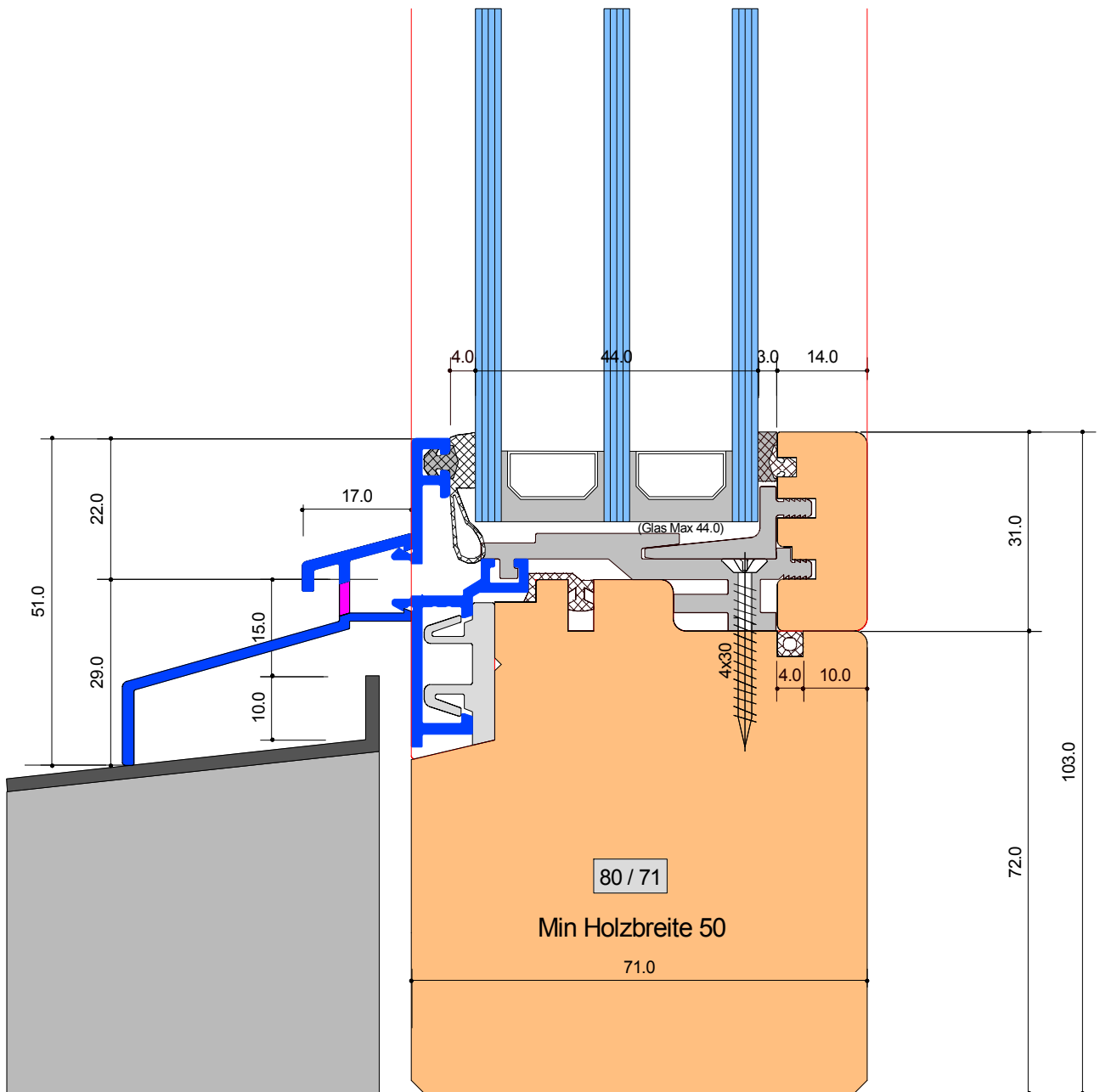

**SYSTEM: M-3 71-74**

Fest i.R. verglast  
 Wetterschenkel Typ RWS 045-013

Detail-Nr :	M -3	D=001R
-------------	------	--------



Von Euw Fenster AG  
 Schoosstrasse 2  
 6418 Rothenthurm

Tel 041 839 80 50  
 Fax 041 839 80 60  
 mail info@voneuw.ch

Ersteller: Adi von Euw  
 Datum: 23.11.16  
 Revidiert:

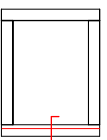

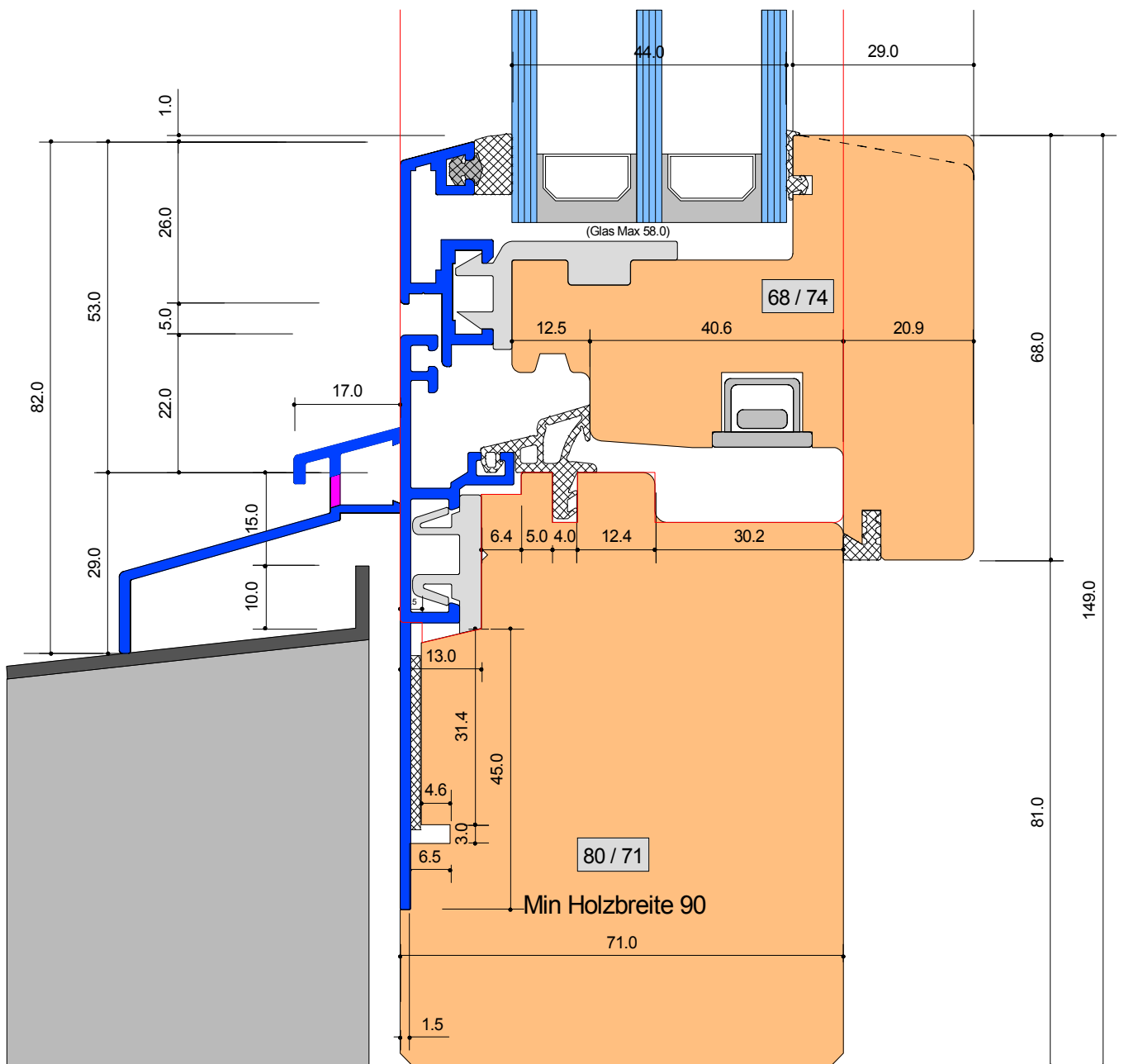

## SYSTEM: M-3 71-74

Anschluss unten mit Alu Fensterbank  
 Wetterschenkel Typ RWS 045-013  
 mit Spezialprofil 92 mm unten

Detail-Nr :	M -3	D=001Z
-------------	------	--------



Von Euw Fenster AG  
 Schoosstrasse 2  
 6418 Rothenthurm

Tel 041 839 80 50  
 Fax 041 839 80 60  
 mail info@voneuw.ch

Ersteller: Adi von Euw  
 Datum: 27.03.17  
 Revidiert:

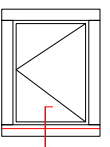

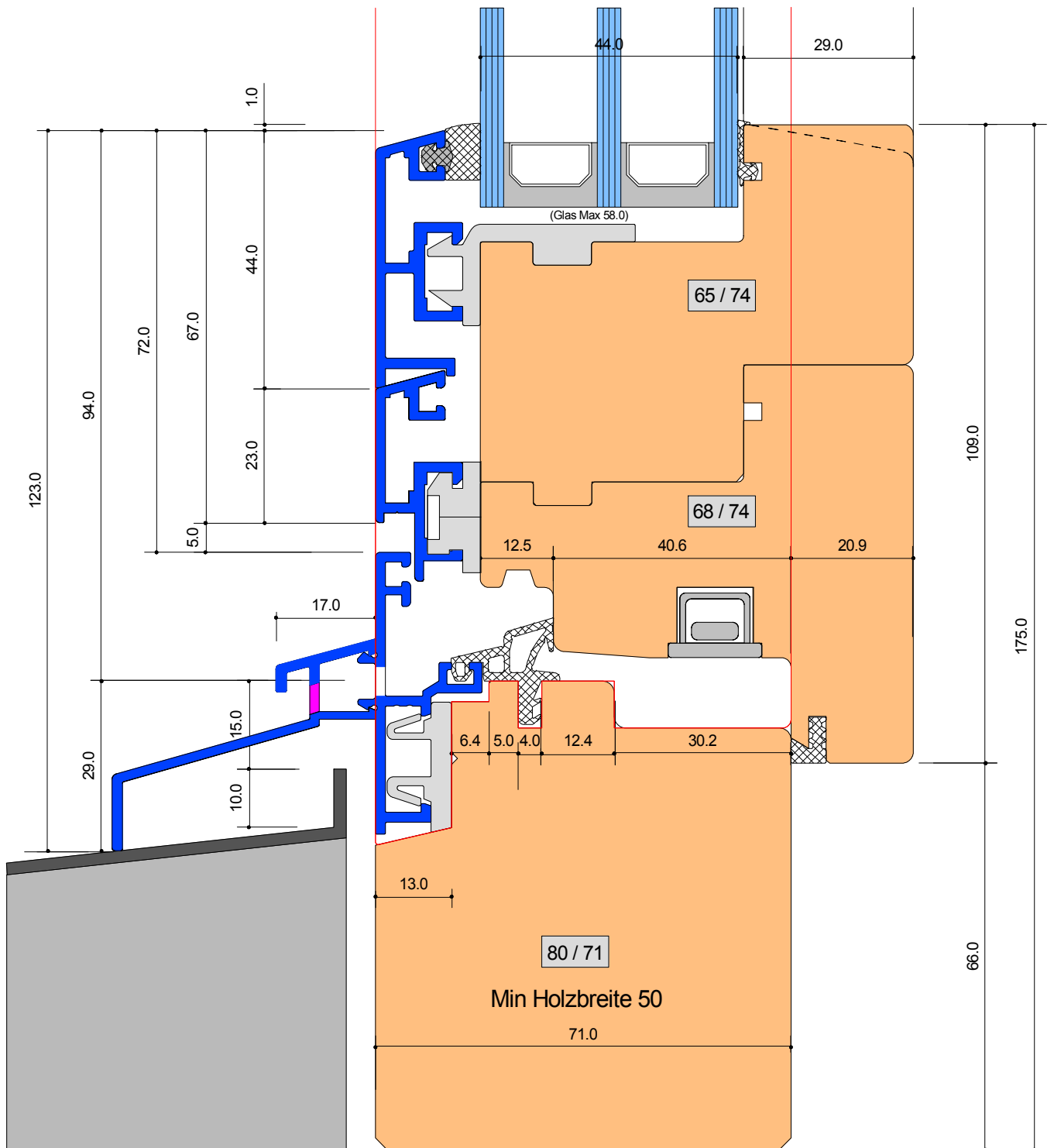

## SYSTEM: M-3 71-74

Anschluss unten BT 109 mm  
Wetterschenkel Typ RWS 045-013

Detail-Nr :	M-3	D=005
-------------	-----	-------



Von Euw Fenster AG  
Schoosstrasse 2  
6418 Rothenthurm

Tel 041 839 80 50  
Fax 041 839 80 60  
mail info@voneuw.ch

Ersteller: Adi von Euw  
Datum: 26.10.15  
Revidiert: 24.10.19

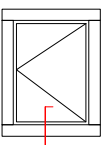

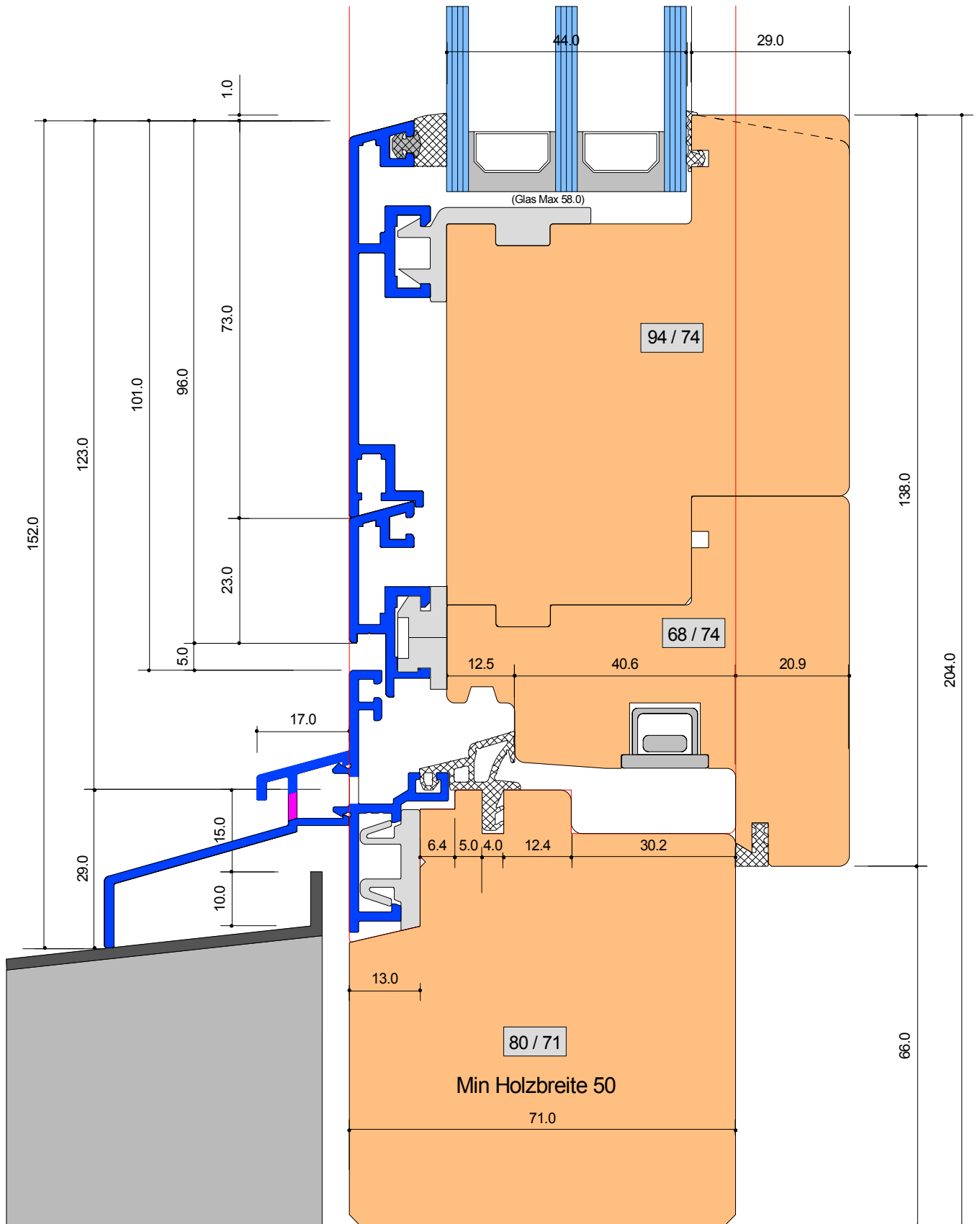

**SYSTEM: M-3 71-74**

Anschluss unten BT 138 mm  
Wetterschenkel Typ RWS 045-013

Detail-Nr :	M -3	D=006
-------------	------	-------



Von Euw Fenster AG  
Schoosstrasse 2  
6418 Rothenthurm

Tel 041 839 80 50  
Fax 041 839 80 60  
mail info@voneuw.ch

Ersteller: Adi von Euw  
Datum: 26.10.15  
Revidiert: 24.10.19

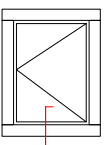

Behindertengerecht

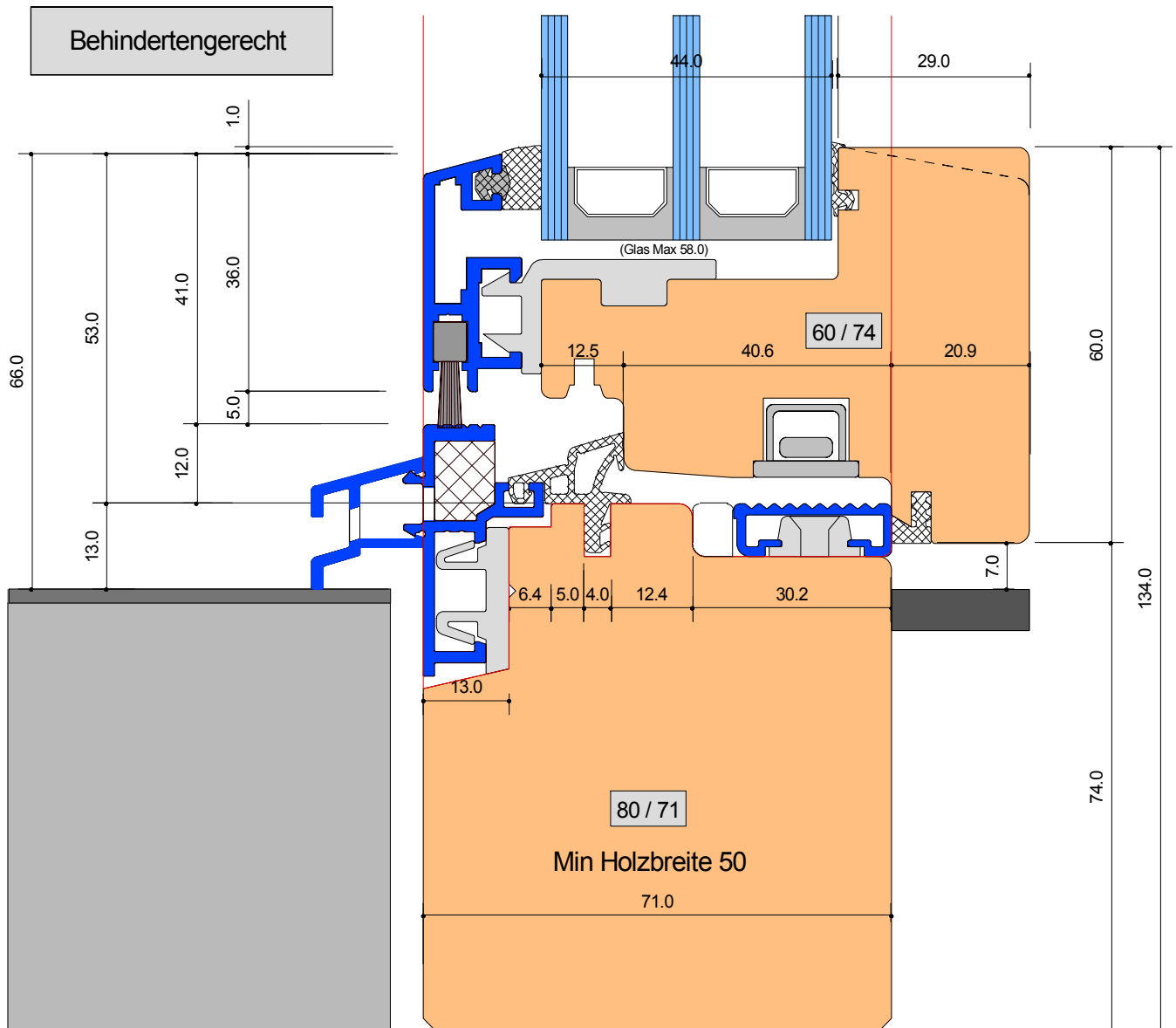

**SYSTEM: M-3 71-74**

Anschluss unten Rollstuhlgängig  
 Mit Flügelbreite 60 mm (-8.0mm)  
 Grundprofil M1-GR 038-18 Roll / Steckteil Variabel

Detail-Nr :	M -3	D=021
-------------	------	-------



Von Euw Fenster AG  
 Schoosstrasse 2  
 6418 Rothenthurm

Tel 041 839 80 50  
 Fax 041 839 80 60  
 mail info@voneuw.ch

Ersteller: Adi von Euw  
 Datum: 26.10.15  
 Revidiert: 24.10.19

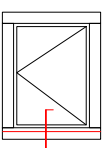



Behindertengerecht

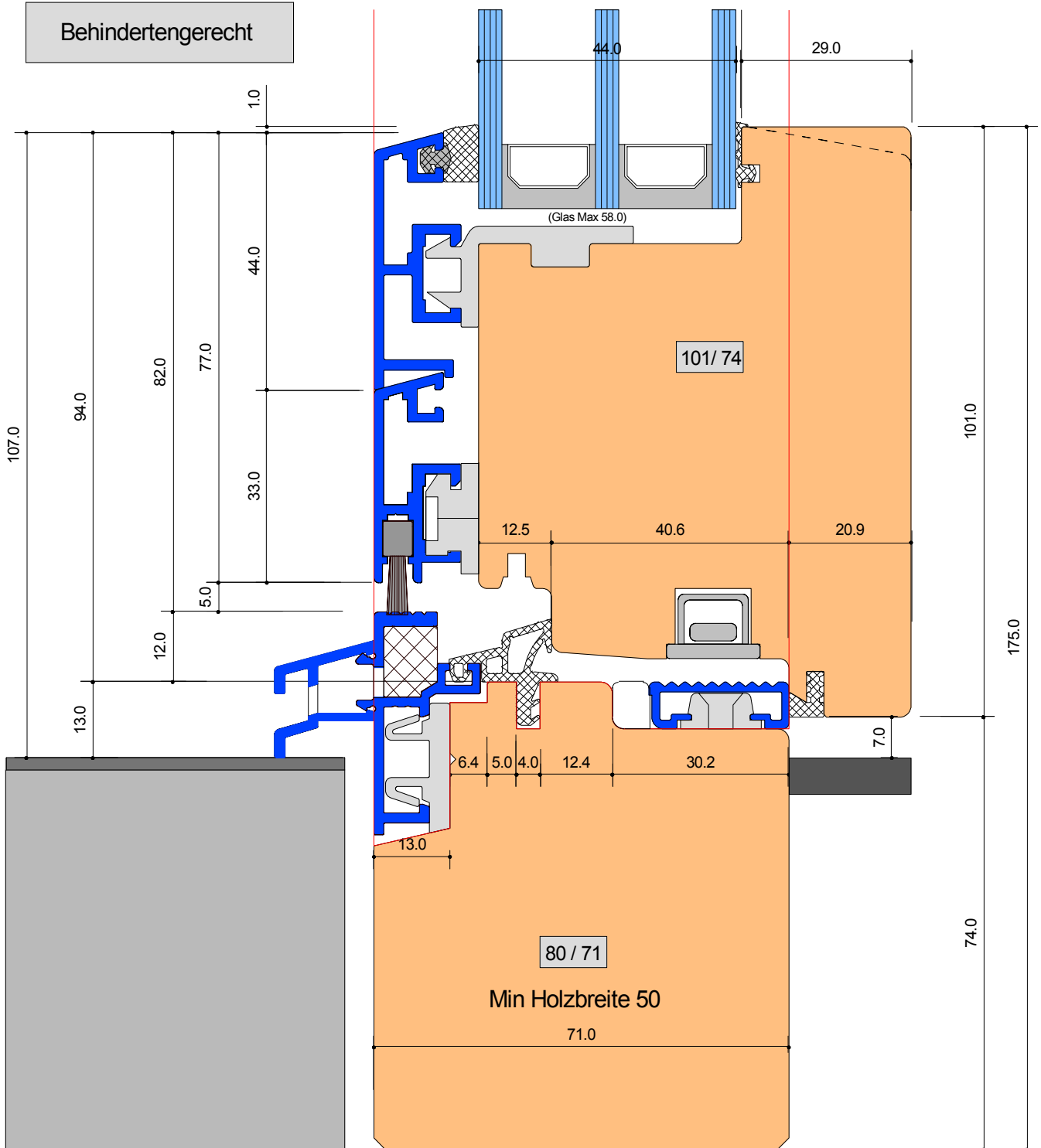

## SYSTEM: M-3 71-74

Anschluss unten Rollstuhlgängig 101 mm  
 Mit Flügelbreite 101 mm (-8.0)  
 Grundprofil M1-GR 038-18 Roll / Steckteil Variabel

Detail-Nr : M-3 D=022



Von Euw Fenster AG  
 Schoosstrasse 2  
 6418 Rothenthurm

Tel 041 839 80 50  
 Fax 041 839 80 60  
 mail info@voneuw.ch

Ersteller: Adi von Euw  
 Datum: 26.10.15  
 Revidiert: 24.10.19

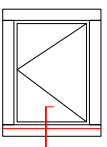

Behindertengerecht

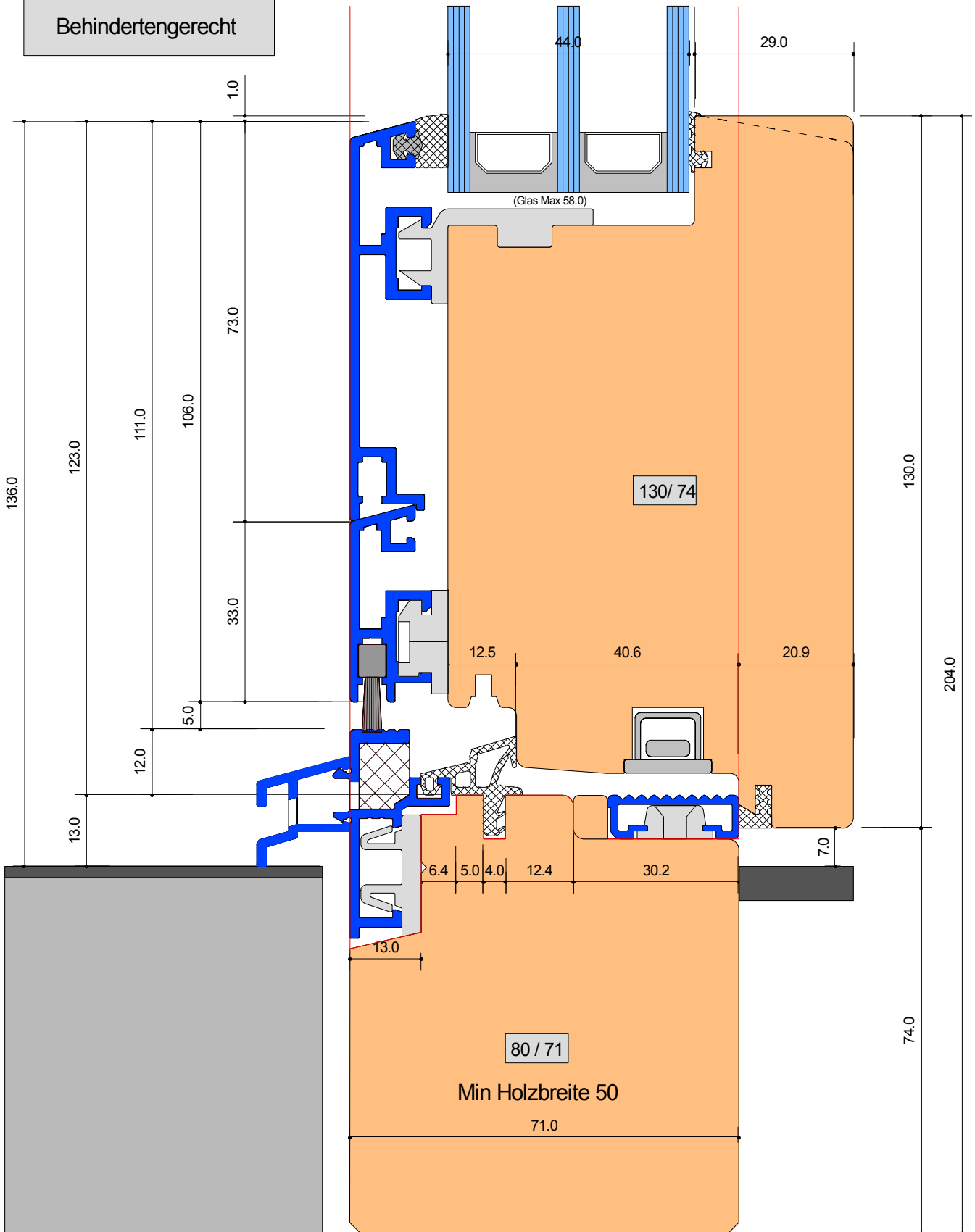

**SYSTEM: M-3 71-74**

Anschluss unten Rollstuhlgängig 130 mm  
 Mit Flügelbreite 130 mm (-8.0)  
 Grundprofil M1-GR 038-18 Roll / Steckteil Variabel

Detail-Nr :	M -3	D=023
-------------	------	-------



Von Euw Fenster AG  
 Schoosstrasse 2  
 6418 Rothenthurn

Tel 041 839 80 50  
 Fax 041 839 80 60  
 mail info@voneuw.ch

Ersteller: Adi von Euw  
 Datum: 26.10.15  
 Revidiert: 24.10.19

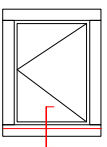

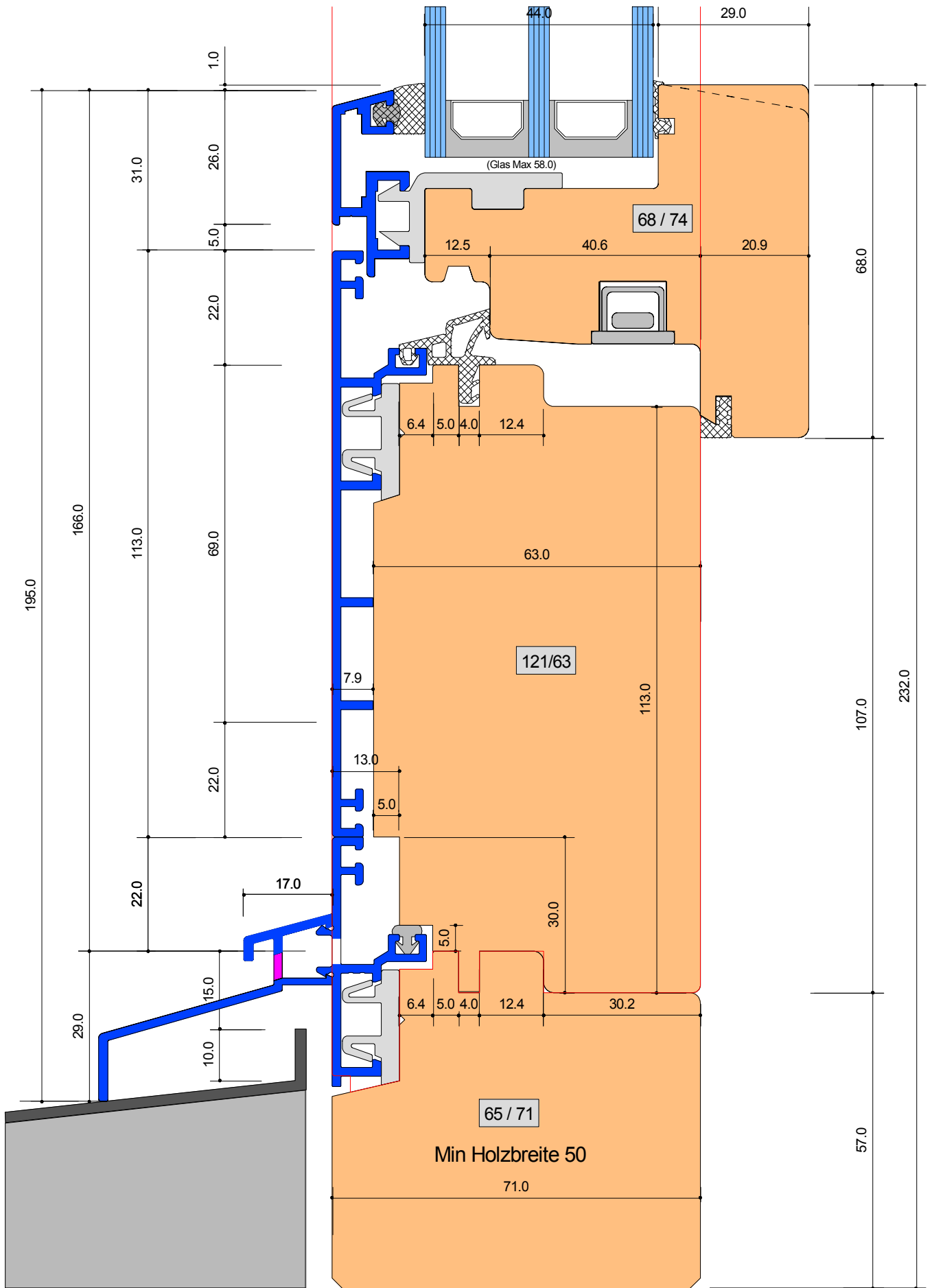

## SYSTEM: M-3 71-74

Anschluss unten mit Einleimer  
Wetterschenkel Typ RWS 045-013

Detail-Nr : M-3 D=031



Von Euw Fenster AG  
Schoosstrasse 2  
6418 Rothenthurm

Tel 041 839 80 50  
Fax 041 839 80 60  
mail info@voneuw.ch

Ersteller: Adi von Euw  
Datum: 26.10.15  
Revidiert:

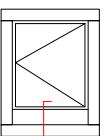

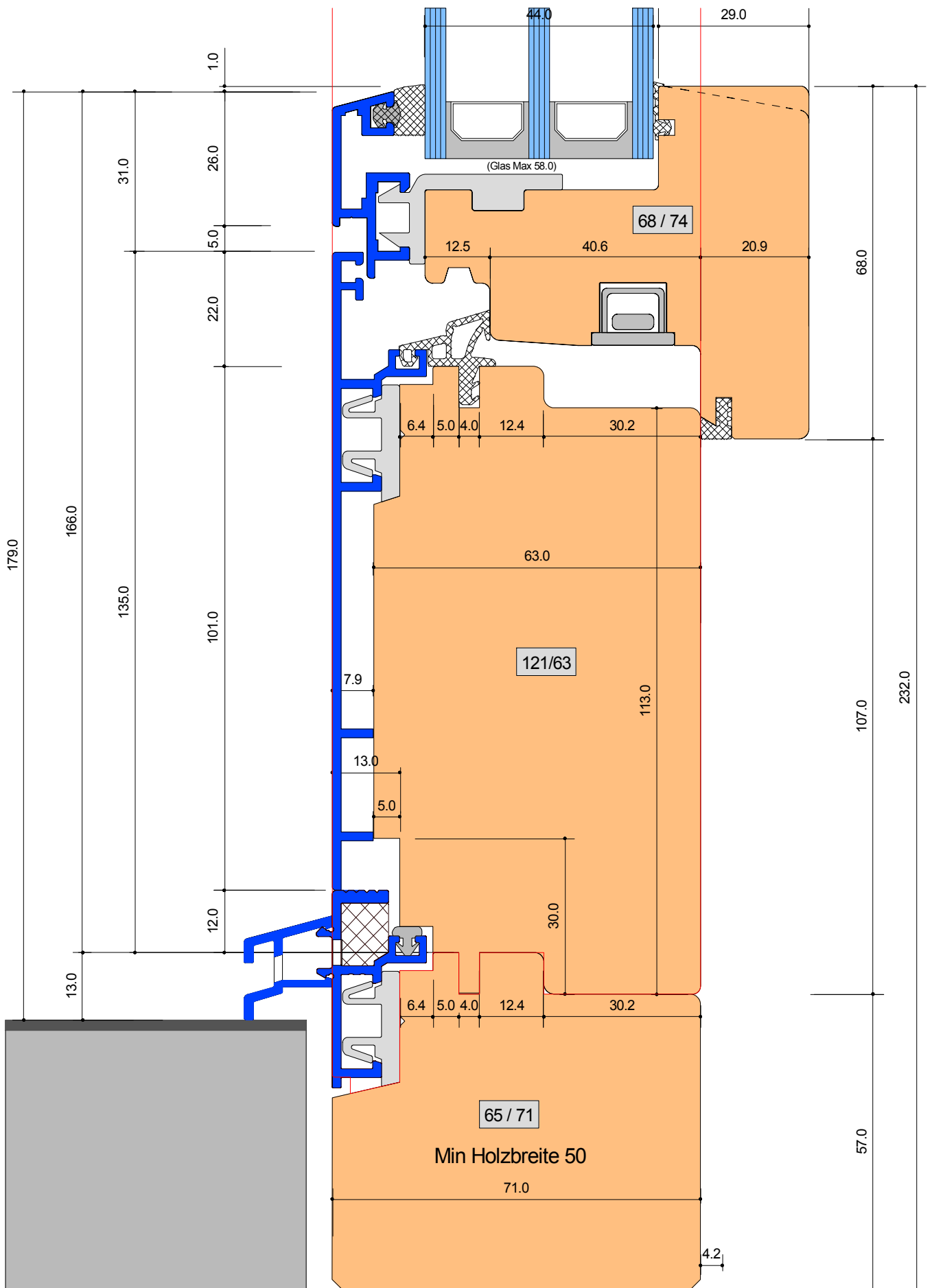

## SYSTEM: M-3 71-74

Anschluss unten Rollstuhlgängig mit Einleimer

Grundprofil M1-GR 038-18 Roll / Steckteil Variabel

Detail-Nr : M-3 D=035



Von Euw Fenster AG  
Schoosstrasse 2  
6418 Rothenthurm

Tel 041 839 80 50  
Fax 041 839 80 60  
mail info@voneuw.ch

Ersteller: Adi von Euw  
Datum: 26.10.15  
Revidiert: 24.10.19

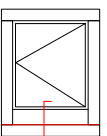

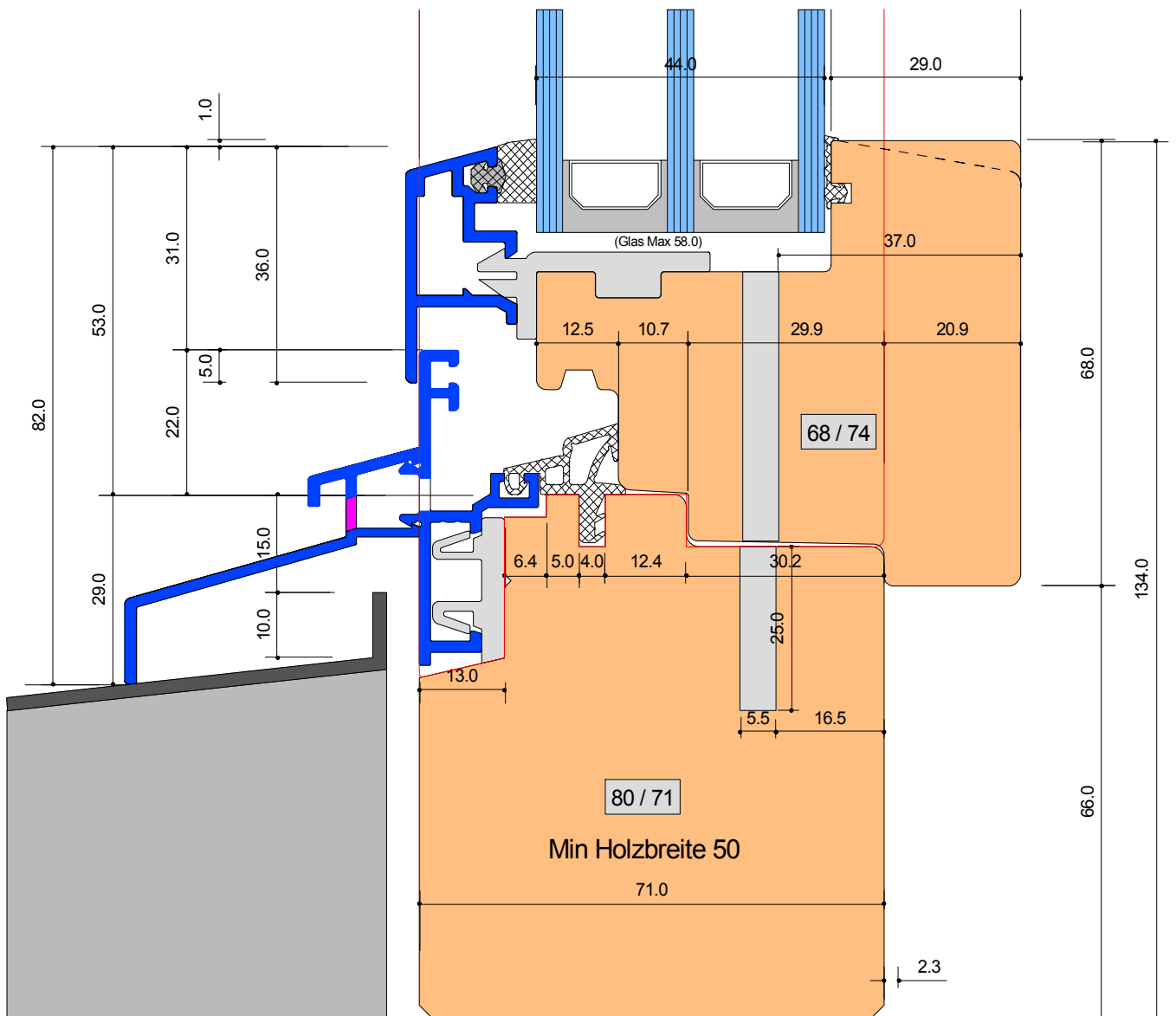

## SYSTEM: M-3 71-74

Anschluss unten mit Alu Fensterbank  
 Wetterschenkel Typ RWS 045-013  
 Fest verglast von aussen eingesetzt Flg 68 mm

Detail-Nr :	M -3	D=041
-------------	------	-------



Von Euw Fenster AG  
 Schoosstrasse 2  
 6418 Rothenthurm

Tel 041 839 80 50  
 Fax 041 839 80 60  
 mail info@voneuw.ch

Ersteller: Adi von Euw  
 Datum: 26.10.15  
 Revidiert:

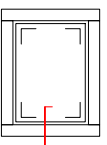

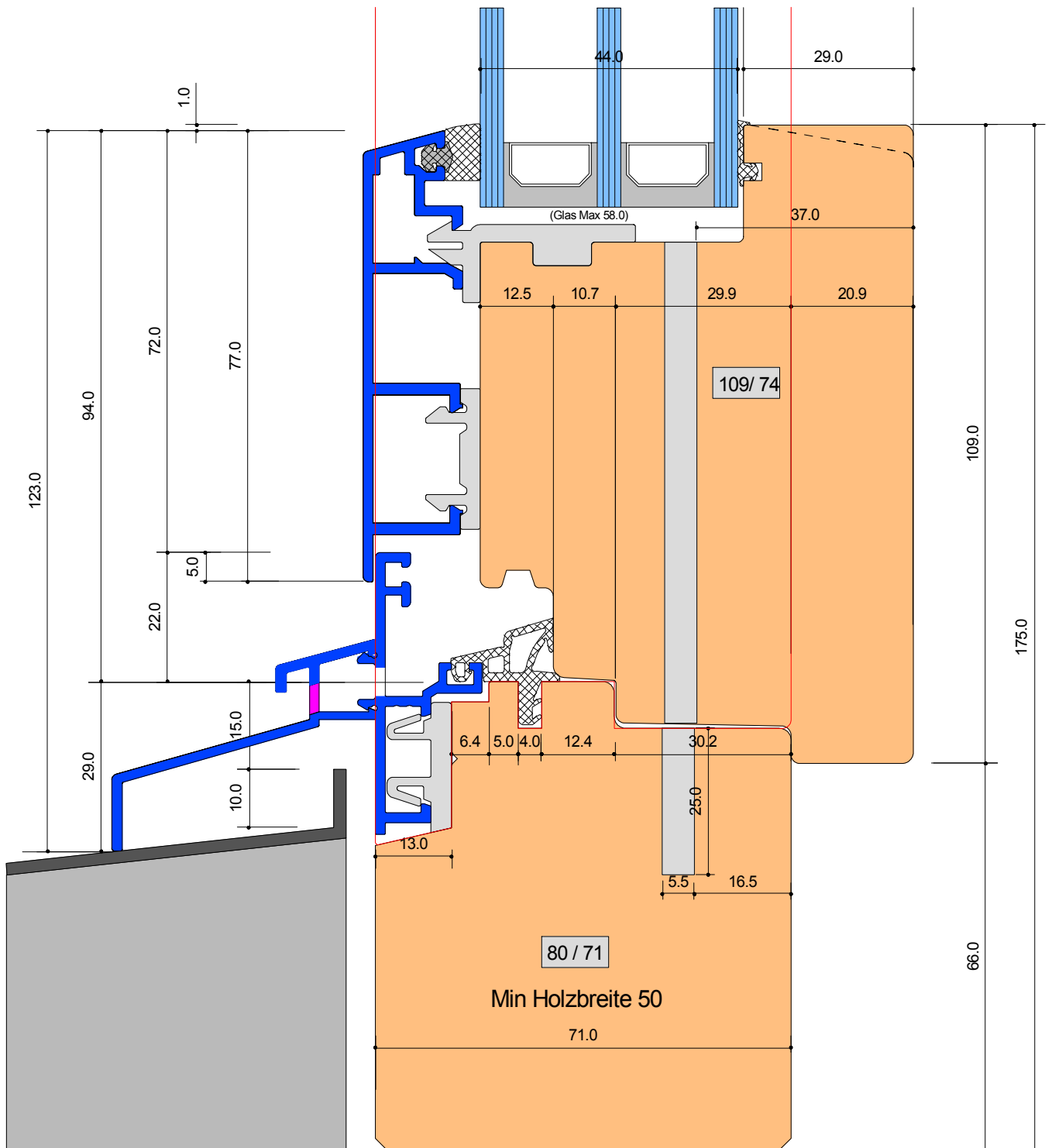

## SYSTEM: M-3 71-74

Anschluss unten mit Alu Fensterbank  
 Wetterschenkel Typ RWS 045-013  
 Fest verglast von aussen eingesetzt Fig 109 mm

Detail-Nr :	M -3	D=042
-------------	------	-------



Von Euw Fenster AG  
 Schoosstrasse 2  
 6418 Rothenthurm

Tel 041 839 80 50  
 Fax 041 839 80 60  
 mail info@voneuw.ch

Ersteller: Adi von Euw  
 Datum: 26.10.15  
 Revidiert:

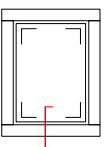

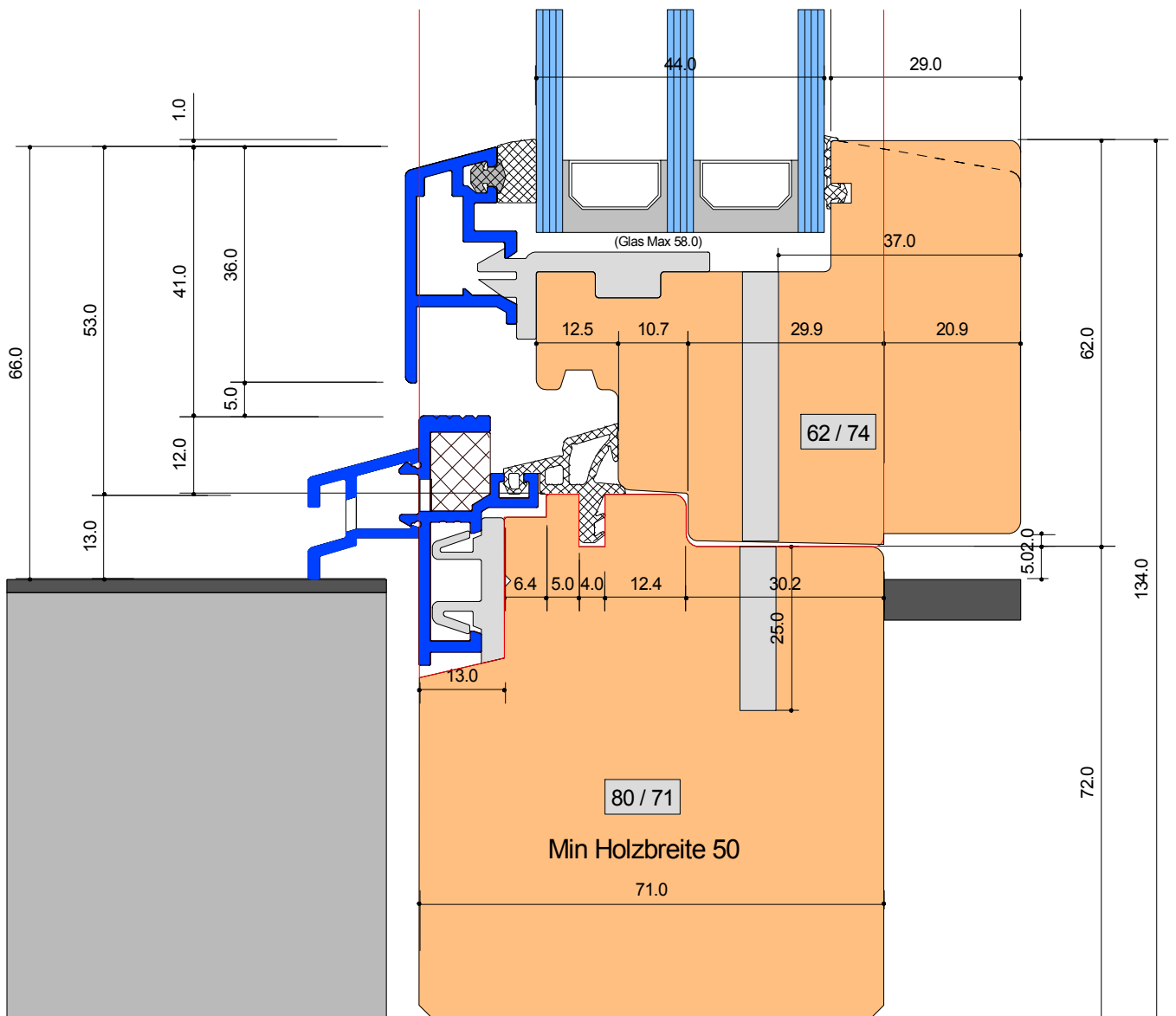

## SYSTEM: M-3 71-74

Anschluss unten Rollstuhlgängig  
 Standart Flügelbreite 62 mm (-6.0mm) Fest vergl. v.aussen  
 Grundprofil M1-GR 038-18 Roll / Steckteil Variabel

Detail-Nr :	M -3	D=045
-------------	------	-------



Von Euw Fenster AG  
 Schoosstrasse 2  
 6418 Rothenthurm

Tel 041 839 80 50  
 Fax 041 839 80 60  
 mail info@voneuw.ch

Ersteller: Adi von Euw  
 Datum: 26.10.15  
 Revidiert: 24.10.19

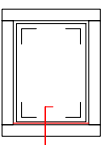

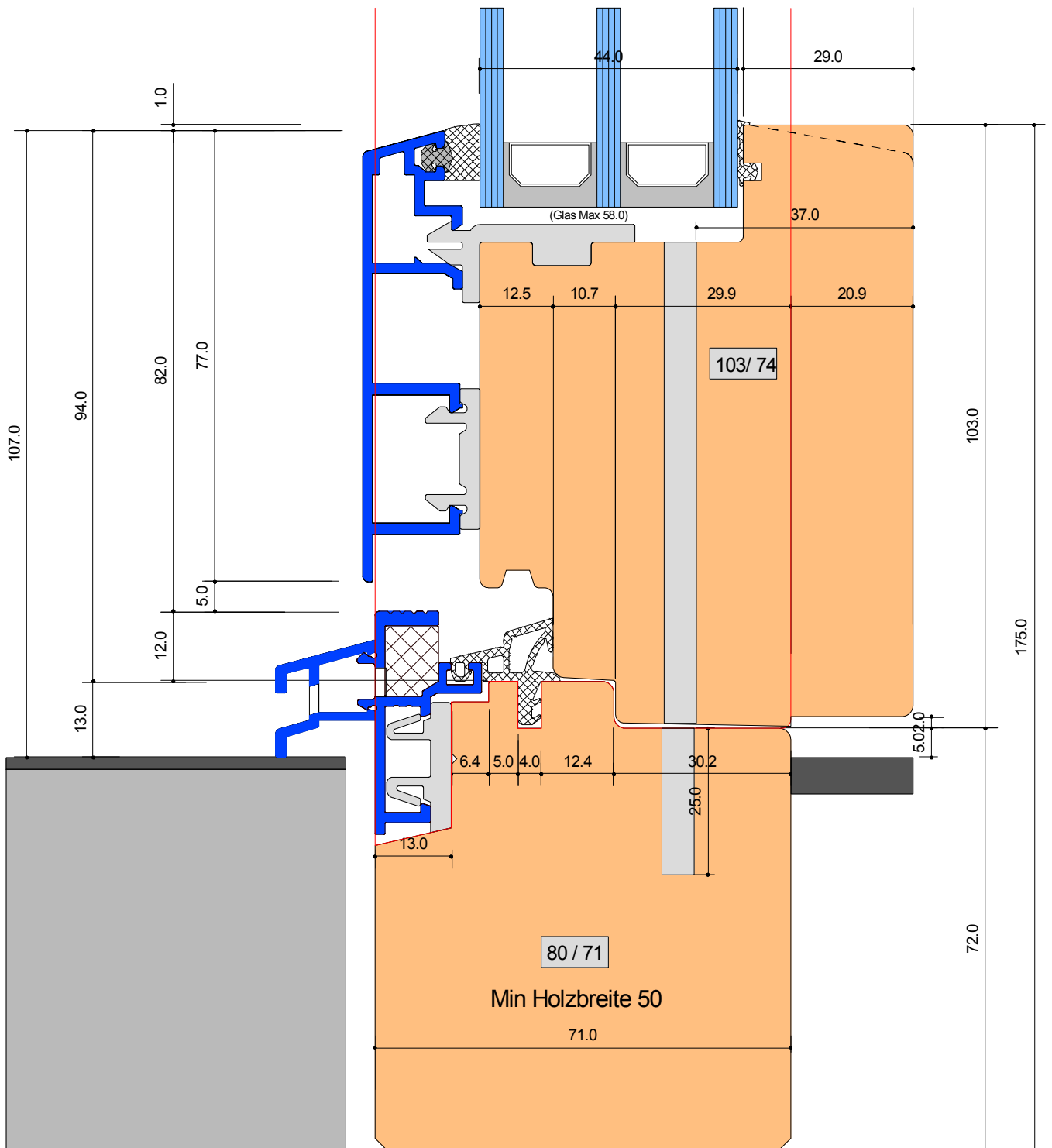

## SYSTEM: M-3 71-74

Anschluss unten Rollstuhlgängig  
 Mit Flügelbreite 103 (-6.0mm) Fest vergl. v. aussen  
 Grundprofil M1-GR 038-18 Roll / Steckteil Variabel

Detail-Nr :	M -3	D=046
-------------	------	-------



Von Euw Fenster AG  
 Schoosstrasse 2  
 6418 Rothenthurm

Tel 041 839 80 50  
 Fax 041 839 80 60  
 mail info@voneuw.ch

Ersteller: Adi von Euw  
 Datum: 26.10.15  
 Revidiert: 24.10.19

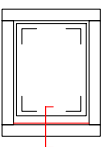



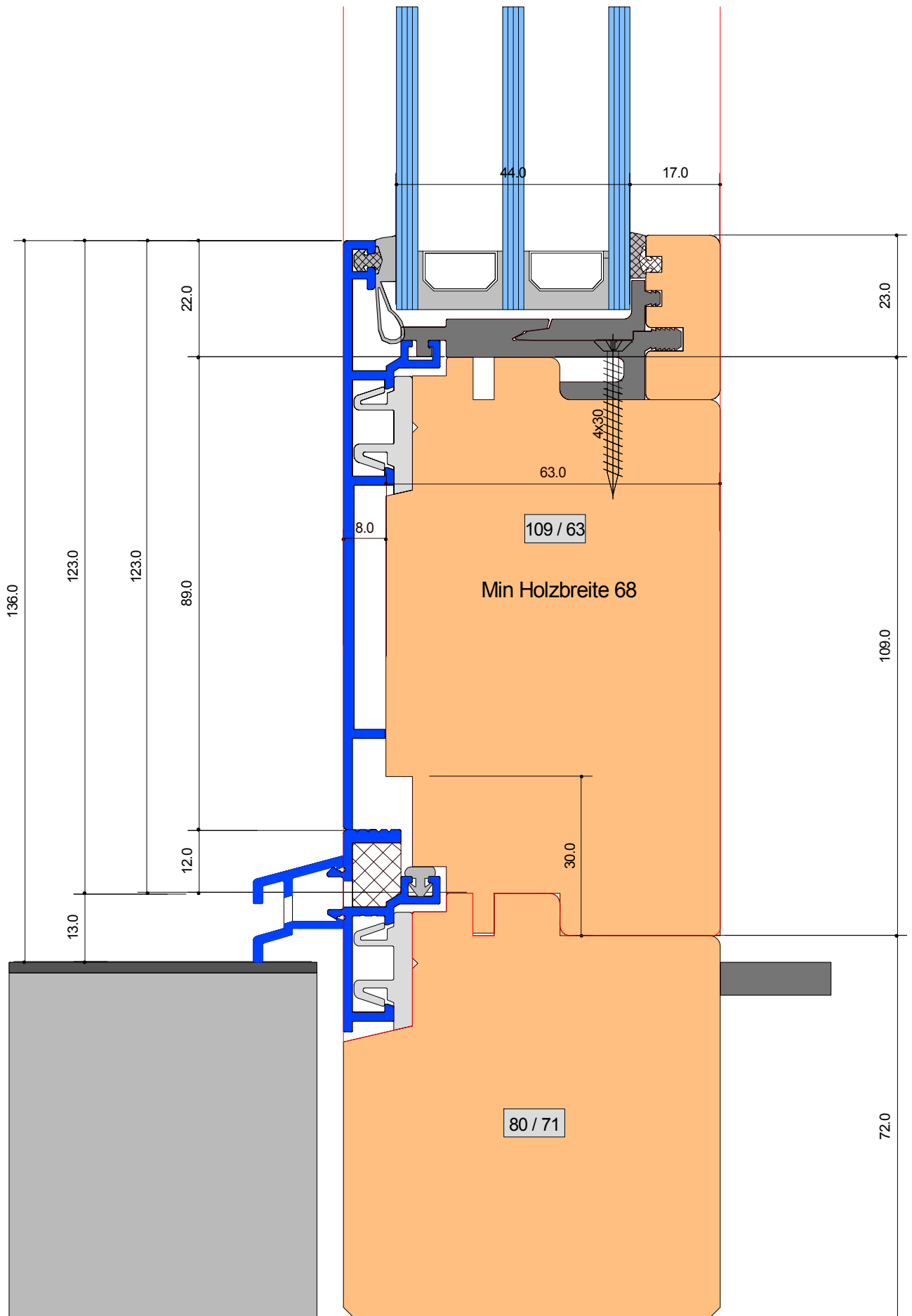

**SYSTEM: M-3 71-74**

Anschluss unten Rollstuhlgängig  
 Fest i.R. verglast mit Einleimer/ paasend zu HT Fr 130 mm  
 Grundprofil M1-GR 038-18 Roll / Steckteil Variabel

Detail-Nr :	M -3	D=047
-------------	------	-------



Von Euw Fenster AG  
 Schoosstrasse 2  
 6418 Rothenthurm

Tel 041 839 80 50  
 Fax 041 839 80 60  
 mail info@voneuw.ch

Ersteller: Adi von Euw  
 Datum: 28.08.17  
 Revidiert: 24.10.19

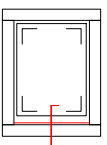

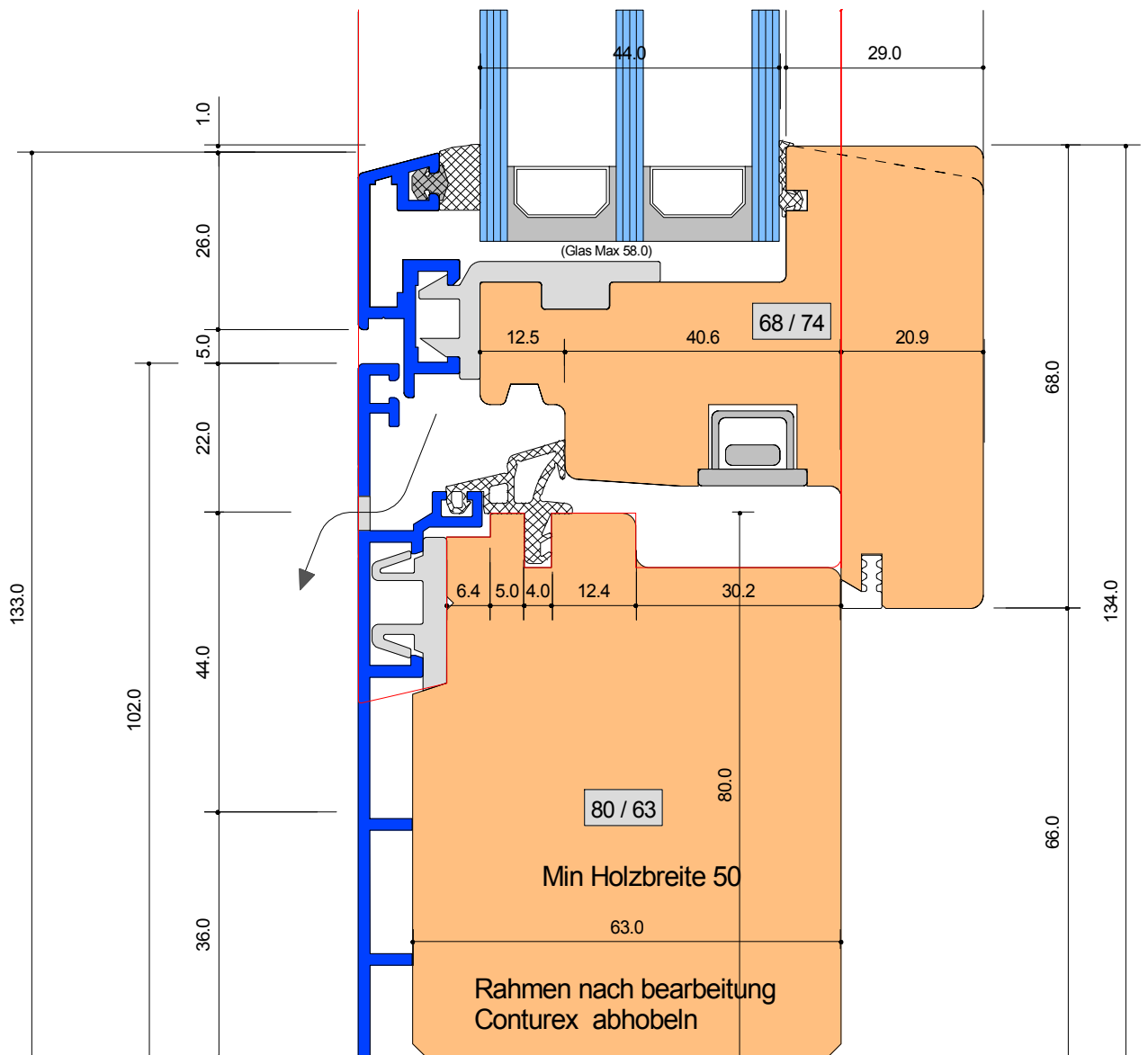

## SYSTEM: M-3 71-74

Blockrahmen (mit oder ohne WS) Mit Alu (113 mm)

Detail-Nr :	M -3	D=051
-------------	------	-------



Von Euw Fenster AG  
Schoosstrasse 2  
6418 Rothenthurm

Tel 041 839 80 50  
Fax 041 839 80 60  
mail info@voneuw.ch

Ersteller: Adi von Euw  
Datum: 26.10.15  
Revidiert:

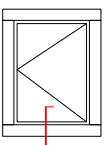

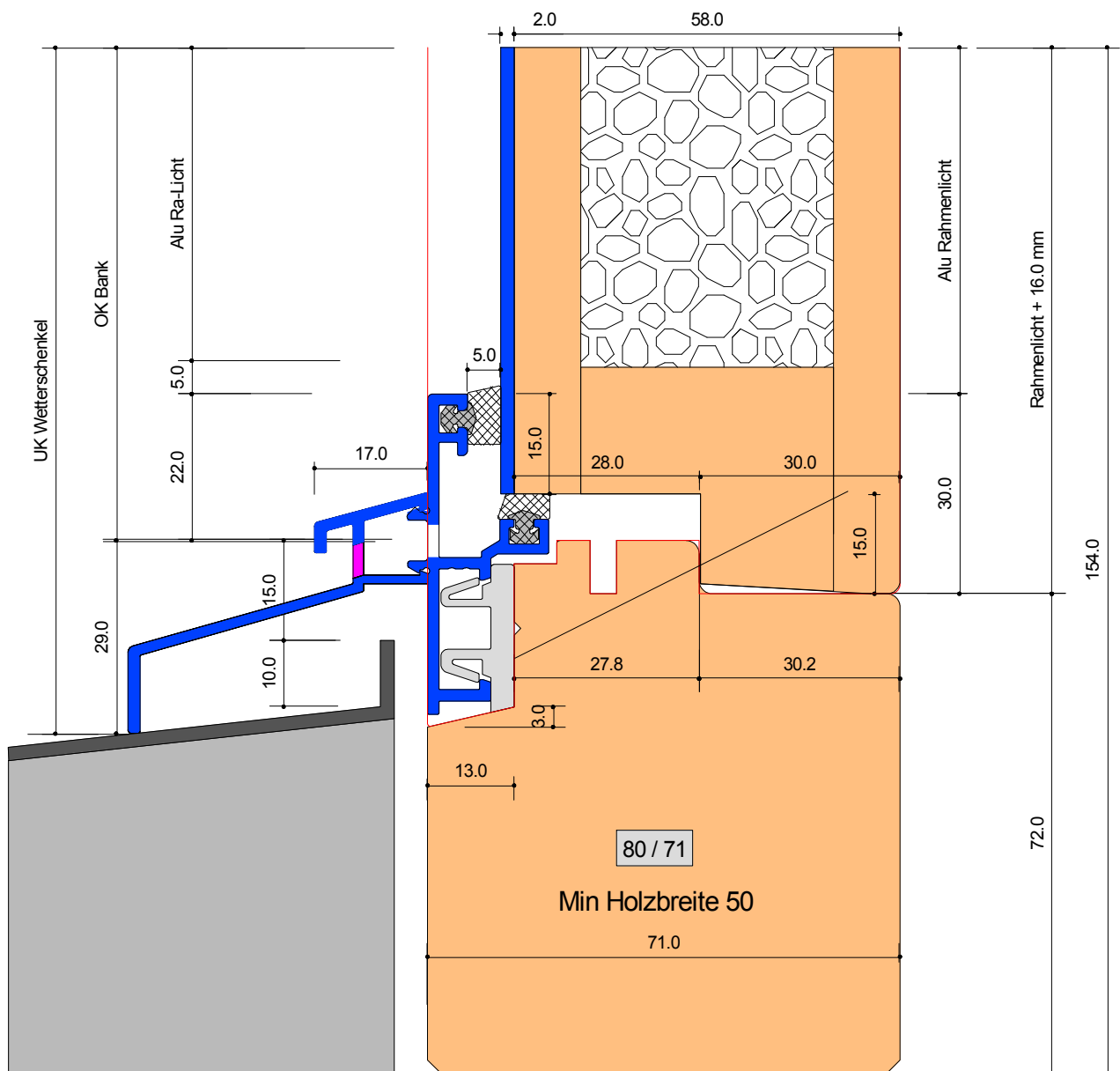

## SYSTEM: M-3 71-74

Anschluss unten mit Alu Fensterbank  
 Wetterschenkel Typ RWS 045-013  
 mit Brüstungseinsatz innen FI-bündig

Detail-Nr :	M -3	D=060
-------------	------	-------



Von Euw Fenster AG  
 Schoosstrasse 2  
 6418 Rothenthurm

Tel 041 839 80 50  
 Fax 041 839 80 60  
 mail info@voneuw.ch

Ersteller: Adi von Euw  
 Datum: 12.10.15  
 Revidiert: 23.01.19

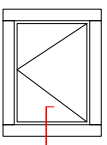

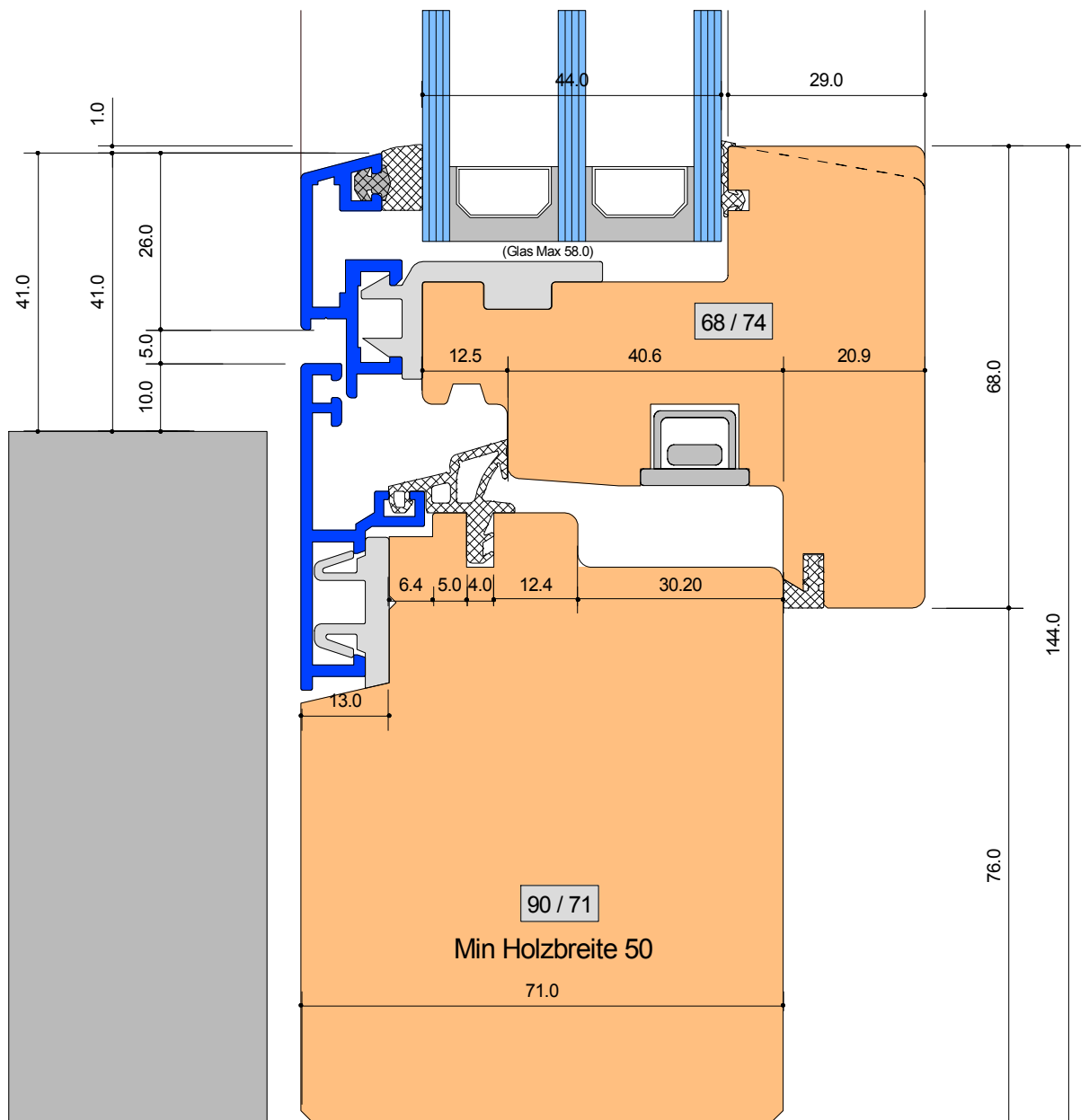

## SYSTEM: M-3 71-74

Anschluss seitlich Standart Flg 68

Detail-Nr :	M -3	D=201
-------------	------	-------



Von Euw Fenster AG  
Schoosstrasse 2  
6418 Rothenthurm

Tel 041 839 80 50  
Fax 041 839 80 60  
mail info@voneuw.ch

Ersteller: Adi von Euw  
Datum: 27.10.15  
Revidiert:

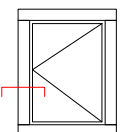

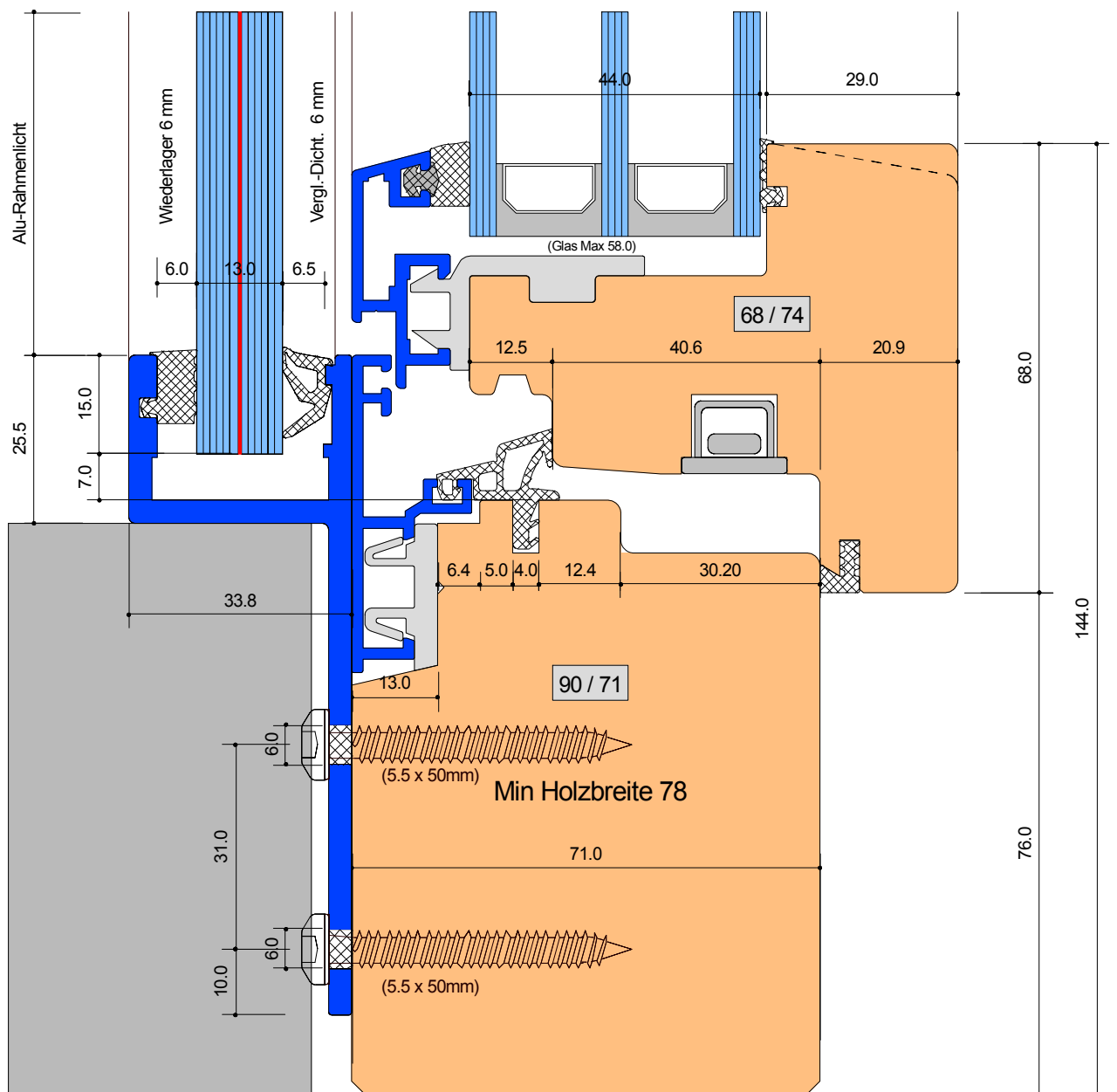

## SYSTEM: M-3 71-74

Anschluss seitlich Standart Flg 68  
mit Brüstungsglas VSG 12-2,  
bis Glasbreite ca 1000 mm

Detail-Nr : M-3 D=201G



Von Euw Fenster AG  
Schoosstrasse 2  
6418 Rothenthurm

Tel 041 839 80 50  
Fax 041 839 80 60

mail info@voneuw.ch

Ersteller: Adi von Euw  
Datum: 27.03.17  
Revidiert:

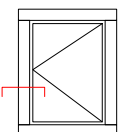

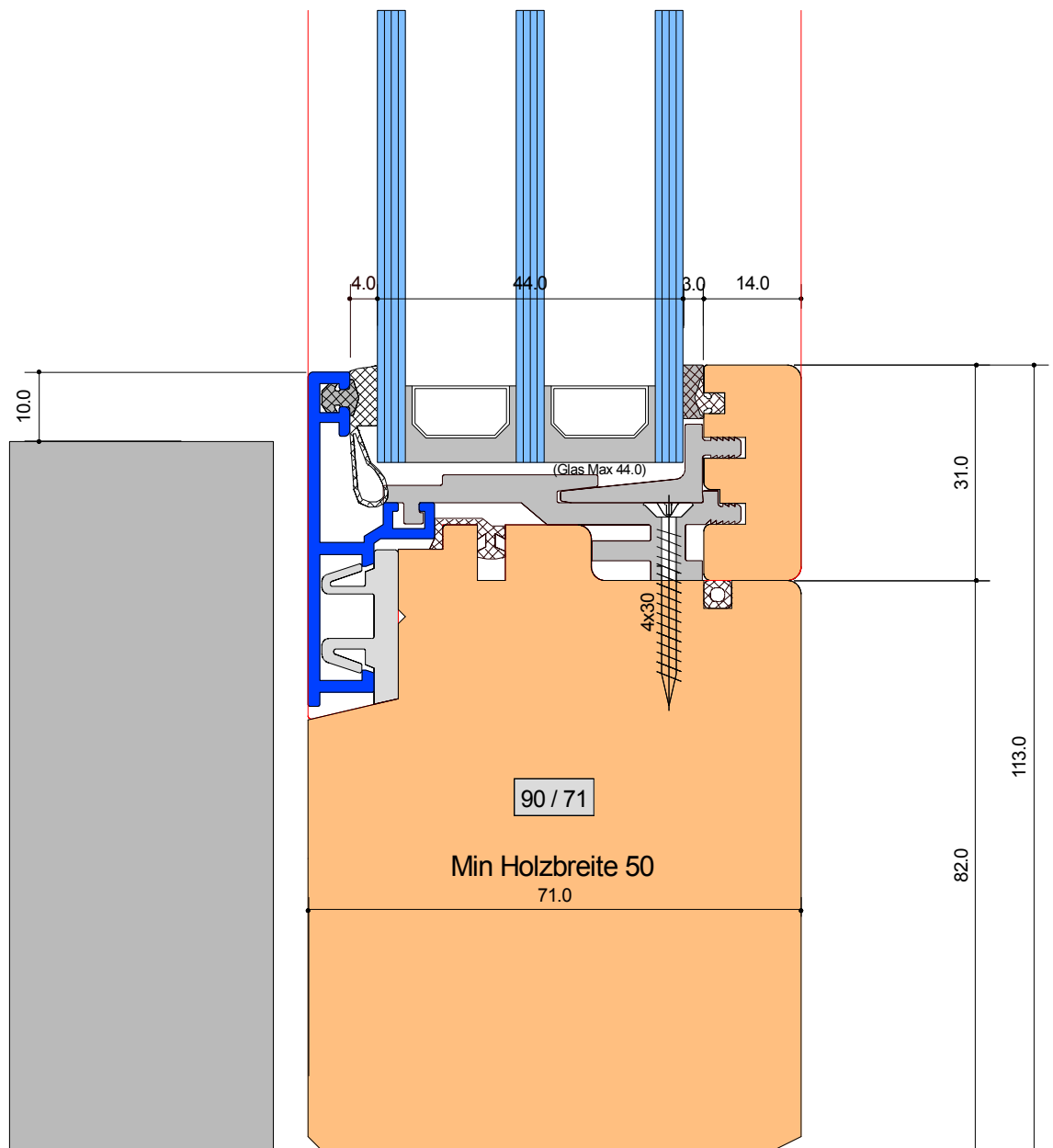

**SYSTEM: M-3 71-74**

Fest i.R. verglast

Detail-Nr :	M -3	D=201R
-------------	------	--------

Ersteller: Adi von Euw  
 Datum: 23.11.16  
 Revidiert:



Von Euw Fenster AG  
 Schoosstrasse 2  
 6418 Rothenthurm

Tel 041 839 80 50  
 Fax 041 839 80 60  
 mail info@voneuw.ch

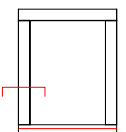

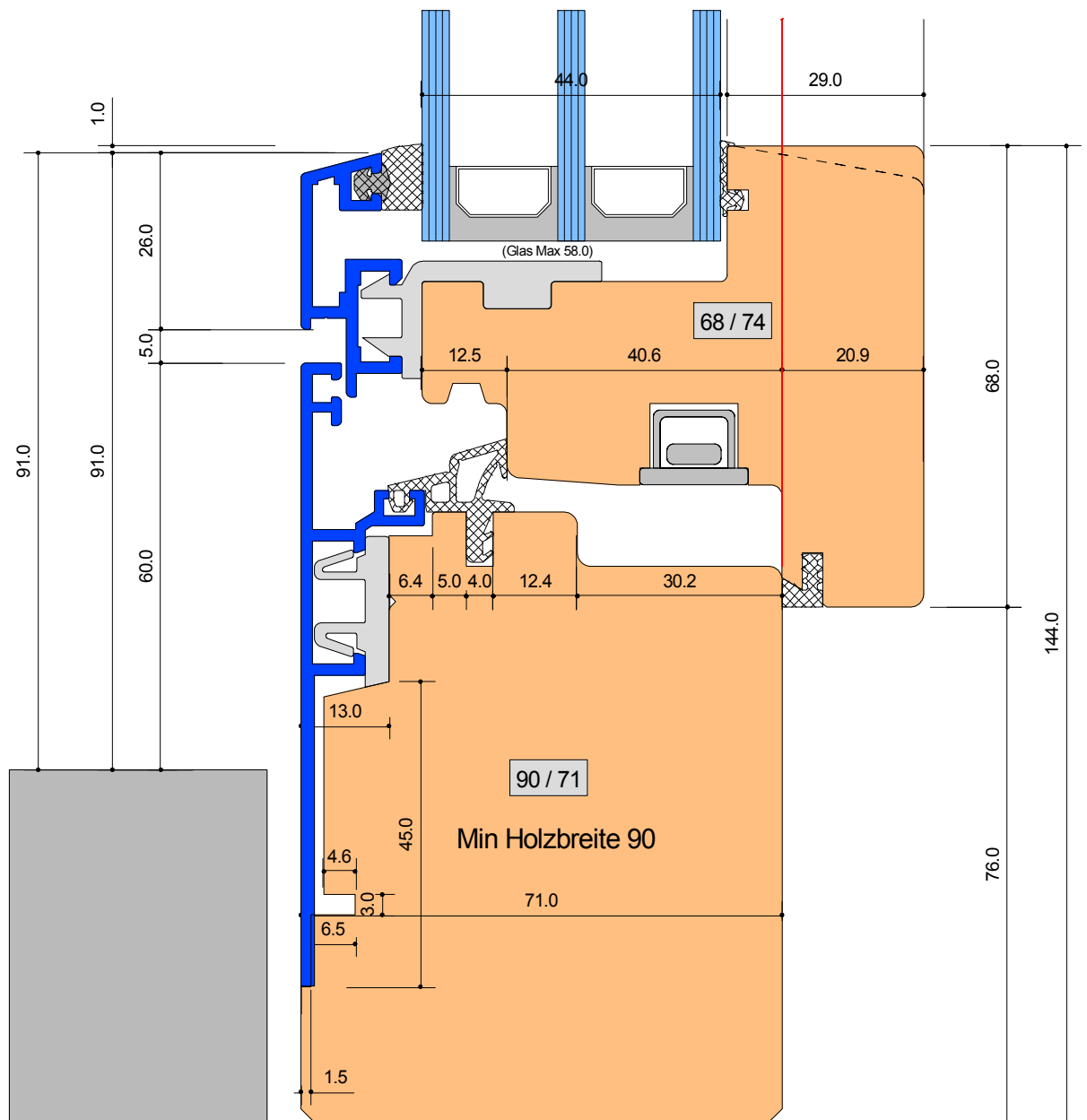

## SYSTEM: M-3 71-74

Anschluss seitlich Standart Flg 68  
mit Spezialprofil 92 mm

Detail-Nr :	M - 3	D=201Z
-------------	-------	--------



Von Euw Fenster AG  
Schoosstrasse 2  
6418 Rothenthurm

Tel 041 839 80 50  
Fax 041 839 80 60  
mail info@voneuw.ch

Ersteller: Adi von Euw  
Datum: 27.10.15  
Revidiert:

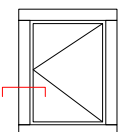

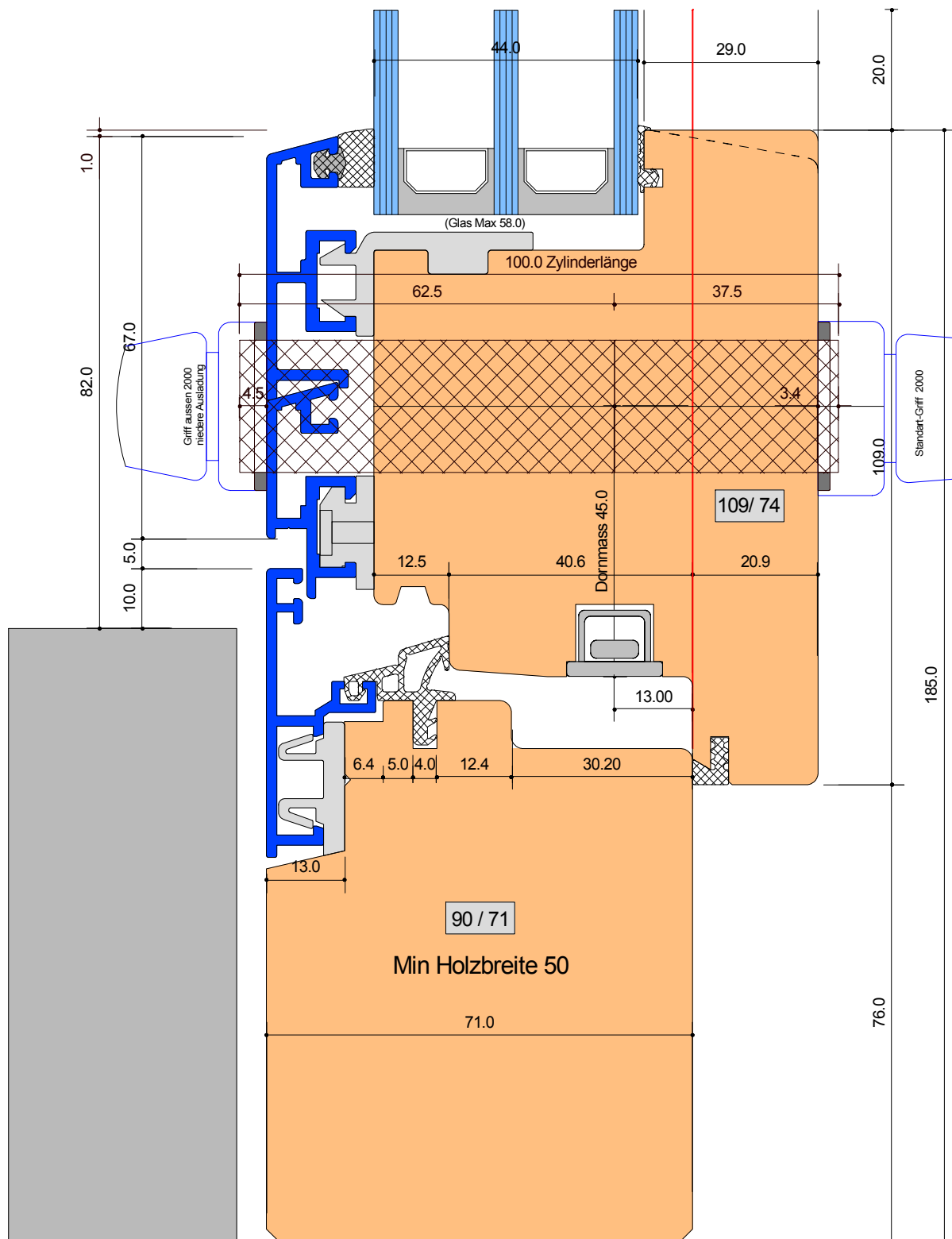

## SYSTEM: M-3 71-74

Anschluss seitlich Standard Flg 109 mm  
 Verschluss durchg. D=45.0 mm Griff m. Knopf/Schlüssel  
 Variante: Verschluss durchg. D=45.0 mm mit Zylinder

Detail-Nr :	M -3	D=205
-------------	------	-------



Von Euw Fenster AG  
 Schoosstrasse 2  
 6418 Rothenthurm

Tel 041 839 80 50  
 Fax 041 839 80 60  
 mail info@voneuw.ch

Ersteller: Adi von Euw  
 Datum: 16.06.16  
 Revidiert:

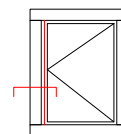



**Variante 1**  
 Schutzschild Glutz  
 ES1 5430S mit Zyl.  
 Schutzrosette (10-14 mm)

**Variante 2**  
 Rund-Schutzrosette Glutz  
 ES1 5330.2S-RS mit Schutz-  
 Einsatz (7-12 einwärts)

**Variante 1**  
 Innenschild Glutz  
 ES1 5435C.2 gerade

**Variante 2**  
 Rund-Rosette innen Glutz  
 5330.C mit Grundplatte

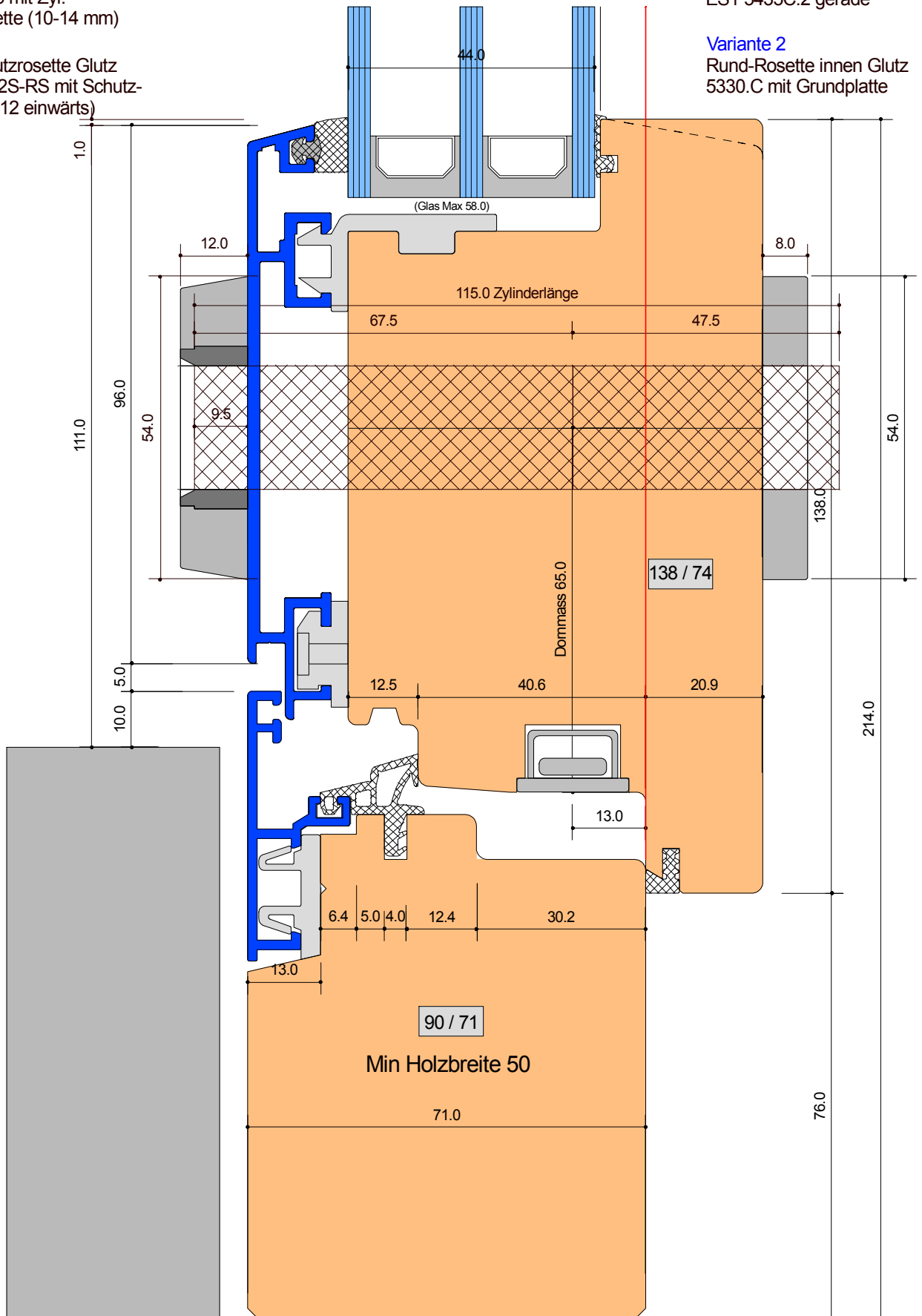

**SYSTEM: M-3 71-74**

Anschluss seitlich mit Flügel 138 mm  
 mit Haustürverschluss D=65 mm  
 mit Sicherheitslängschild Glutz 5430S/5435C.2  
 mit Rund-Ros Glutz ES1 5330.2S-RS/5330C

Detail-Nr :	M-3	D=210
-------------	-----	-------



Von Euw Fenster AG  
 Schoosstrasse 2  
 6418 Rothenthurm

Tel 041 839 80 50  
 Fax 041 839 80 60  
 mail info@voneuw.ch

Ersteller: Adi von Euw  
 Datum: 15.06.16  
 Revidiert:

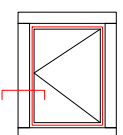

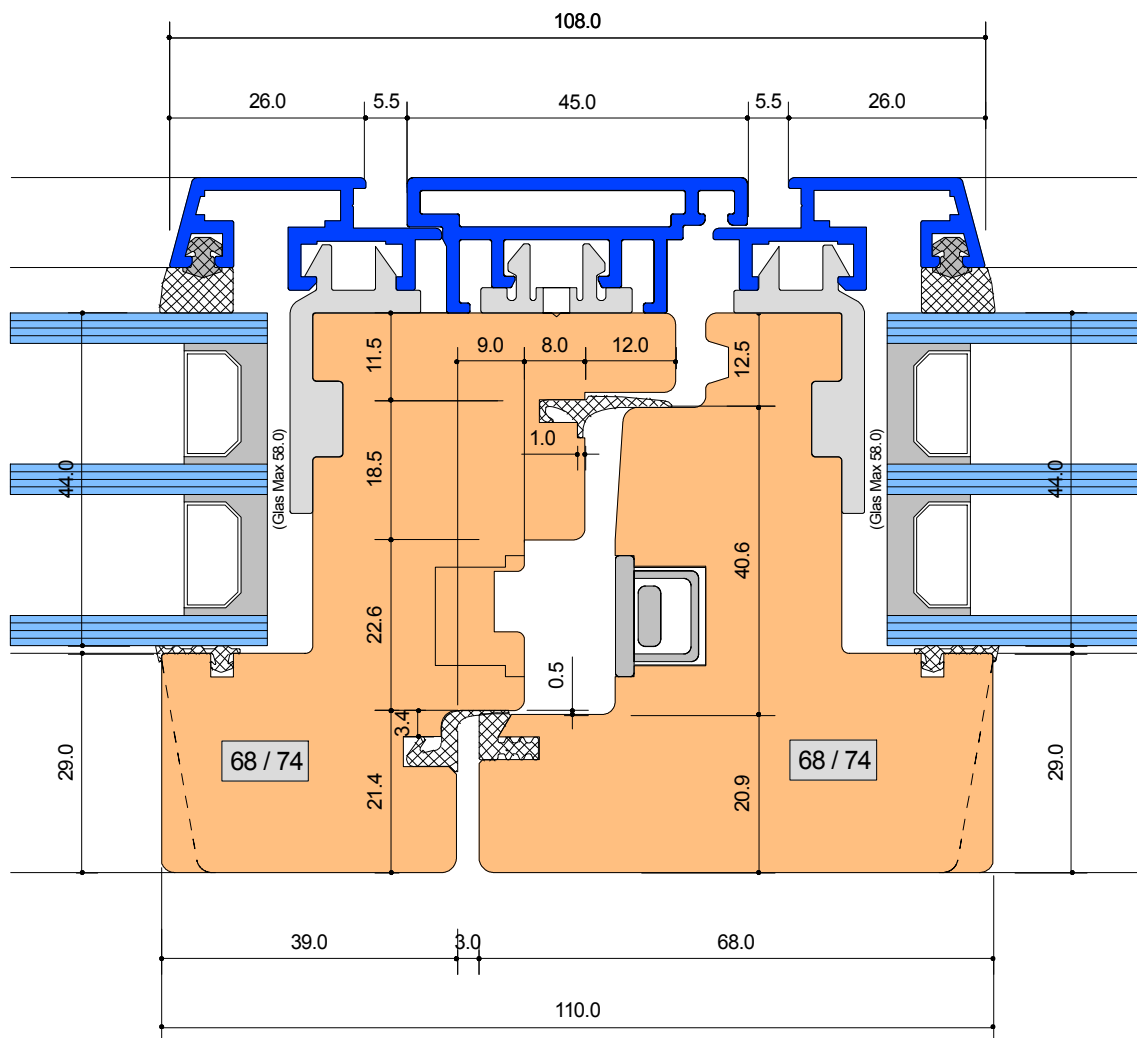

## SYSTEM: M-3 71-74

Mittelpartie Standart 2 x Flg 68

Detail-Nr :	M -3	D=301
-------------	------	-------



Von Euw Fenster AG  
Schoosstrasse 2  
6418 Rothenthurm

Tel 041 839 80 50  
Fax 041 839 80 60  
mail info@voneuw.ch

Ersteller: Adi von Euw  
Datum: 27.10.15  
Revidiert: 24.10.19

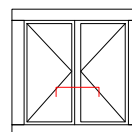

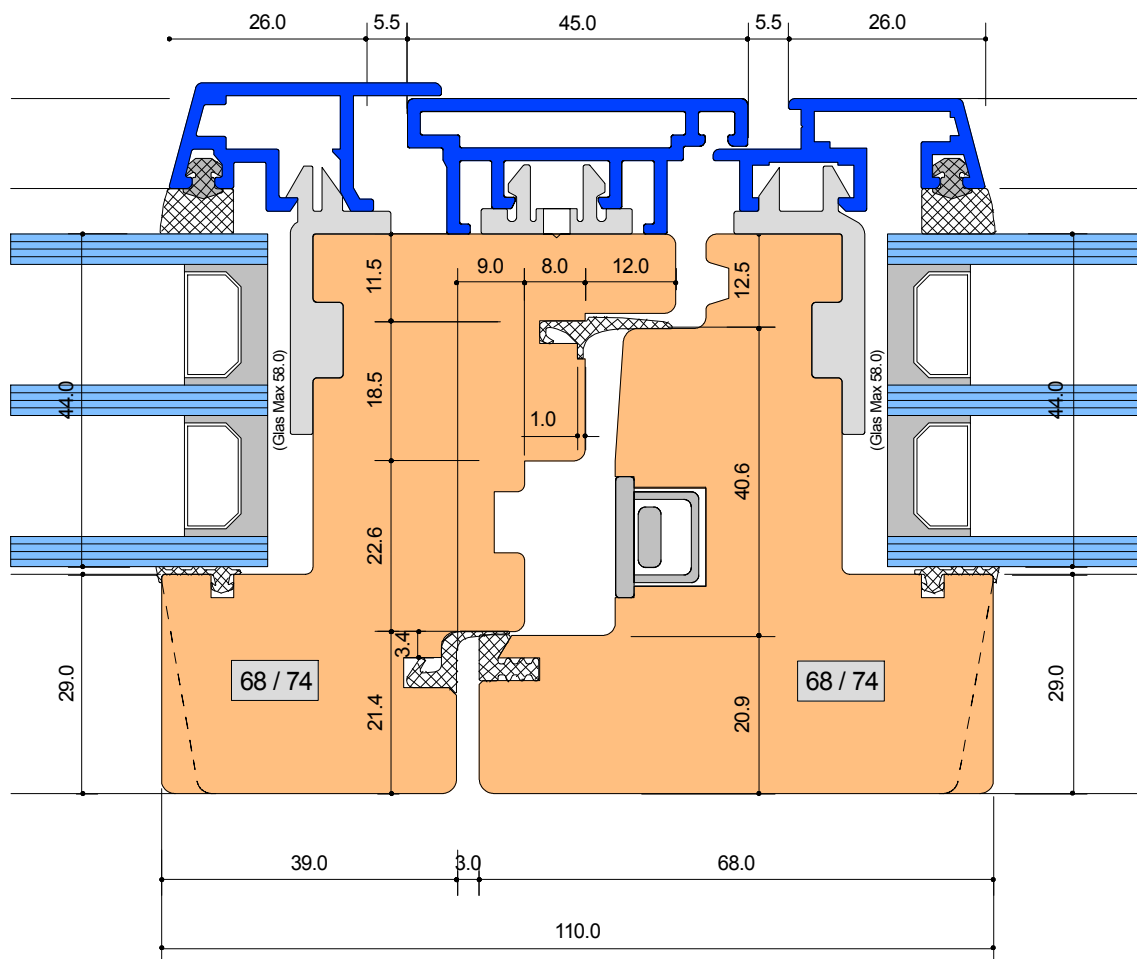

## SYSTEM: M-3 71-74

Mittelpartie einseitig mit fest vergl. Flg v. aussen

Detail-Nr :	M -3	D=310
-------------	------	-------



Von Euw Fenster AG  
Schoosstrasse 2  
6418 Rothenthurm

Tel 041 839 80 50  
Fax 041 839 80 60  
mail info@voneuw.ch

Ersteller: Adi von Euw  
Datum: 27.10.15  
Revidiert: 24.10.19

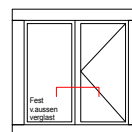

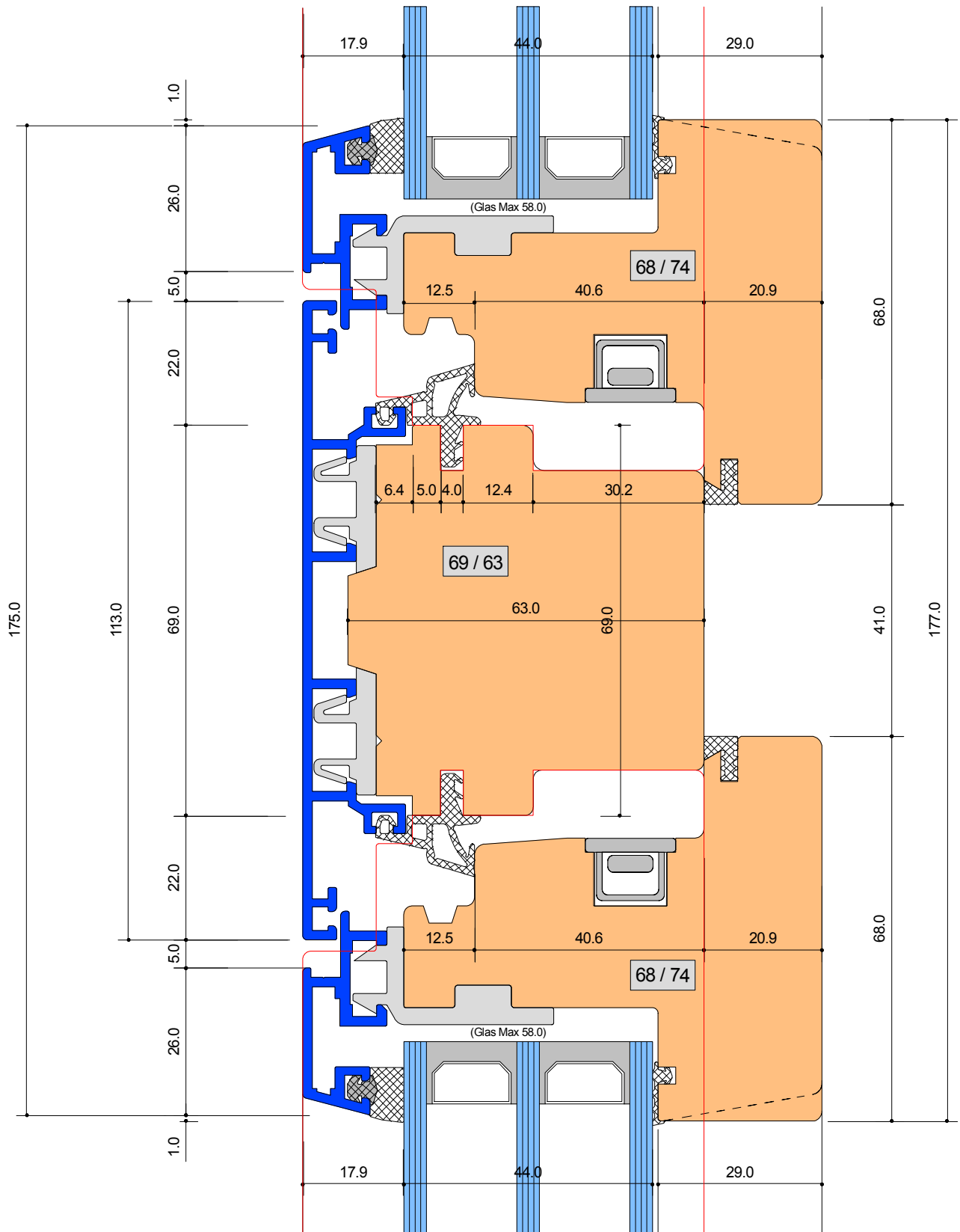

## SYSTEM: M-3 71-74

Kämpfer und Setzholz Alu 113 mm

Detail-Nr : M-3 D=401

Ersteller: Adi von Euw  
Datum: 27.10.15  
Revidiert:



Von Euw Fenster AG  
Schoosstrasse 2  
6418 Rothenthurm

Tel 041 839 80 50  
Fax 041 839 80 60  
mail info@voneuw.ch

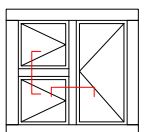

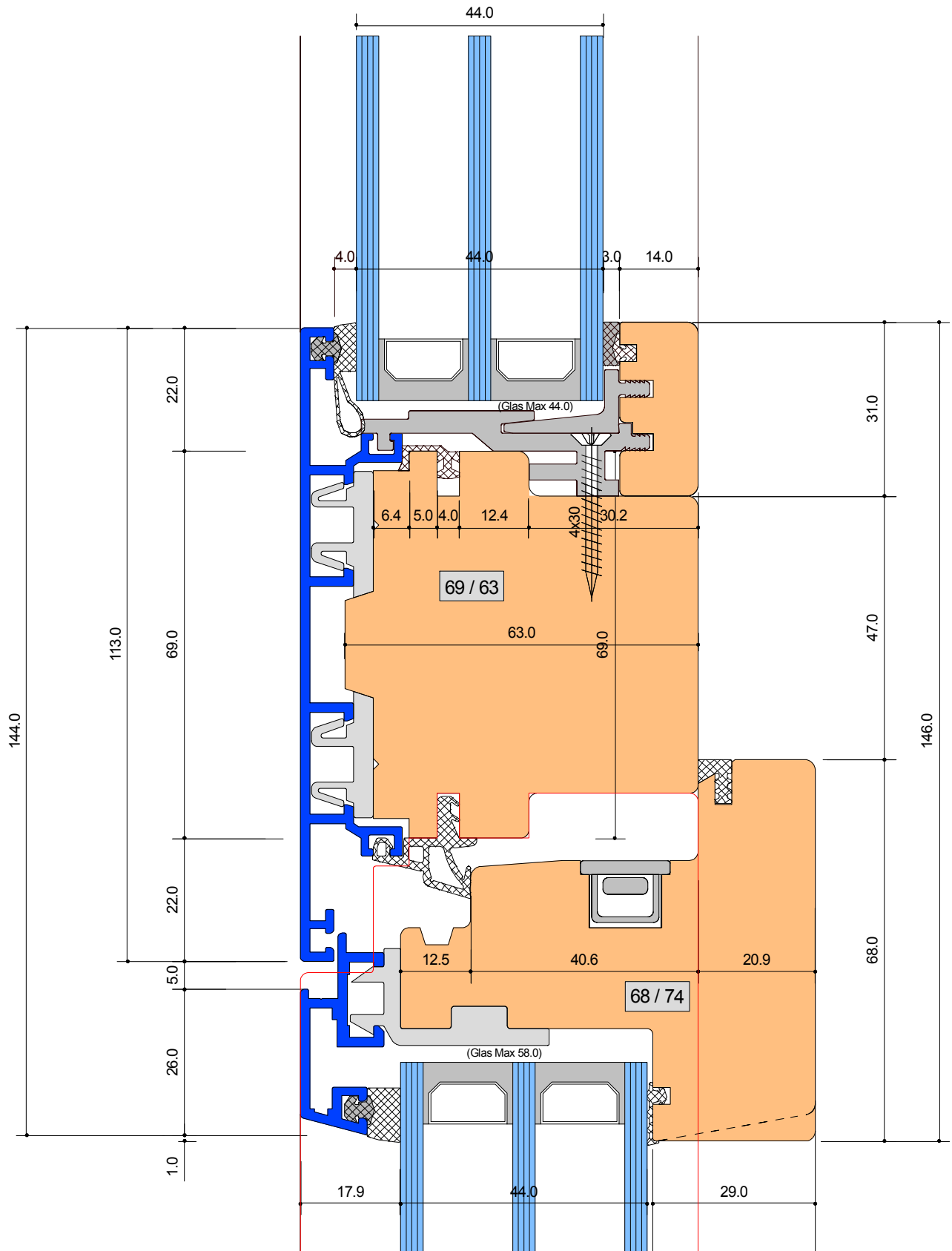

## SYSTEM: M-3 71-74

Kämpfer und Setzholz Alu 113 mm  
einseitig fest i.R. verglast

Detail-Nr : M-3 D=401R



Von Euw Fenster AG  
Schoosstrasse 2  
6418 Rothenthurm

Tel 041 839 80 50  
Fax 041 839 80 60  
mail info@voneuw.ch

Ersteller: Adi von Euw  
Datum: 23.11.16  
Revidiert:

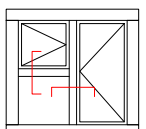

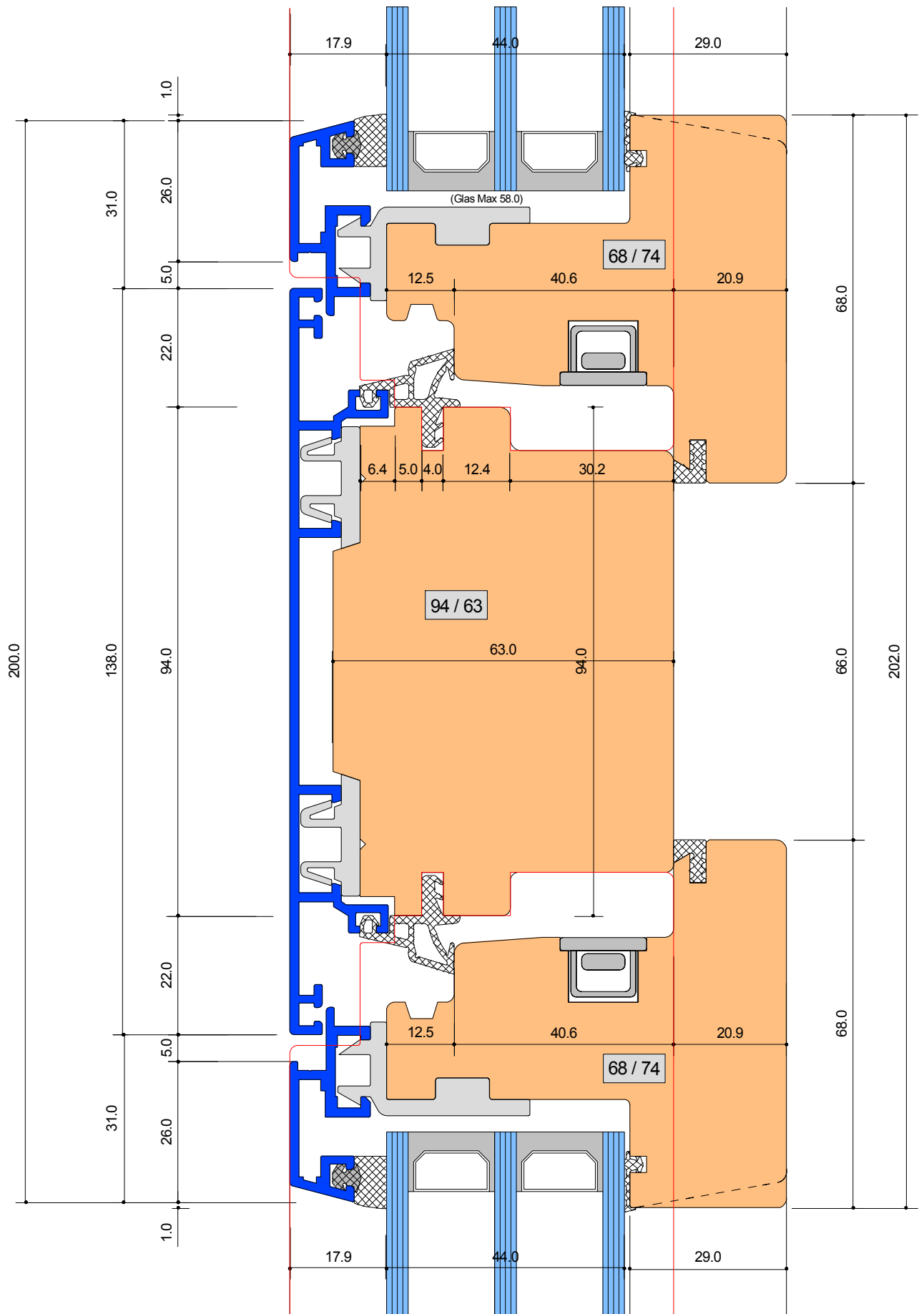

**SYSTEM: M-3 71-74**

Kämpfer und Setzholz Alu 138 mm

Detail-Nr :	M -3	D=402
-------------	------	-------

Ersteller: Adi von Euw  
 Datum: 27.10.15  
 Revidiert:



Von Euw Fenster AG  
 Schoosstrasse 2  
 6418 Rothenthurm

Tel 041 839 80 50  
 Fax 041 839 80 60  
 mail info@voneuw.ch

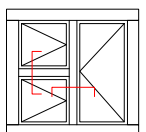

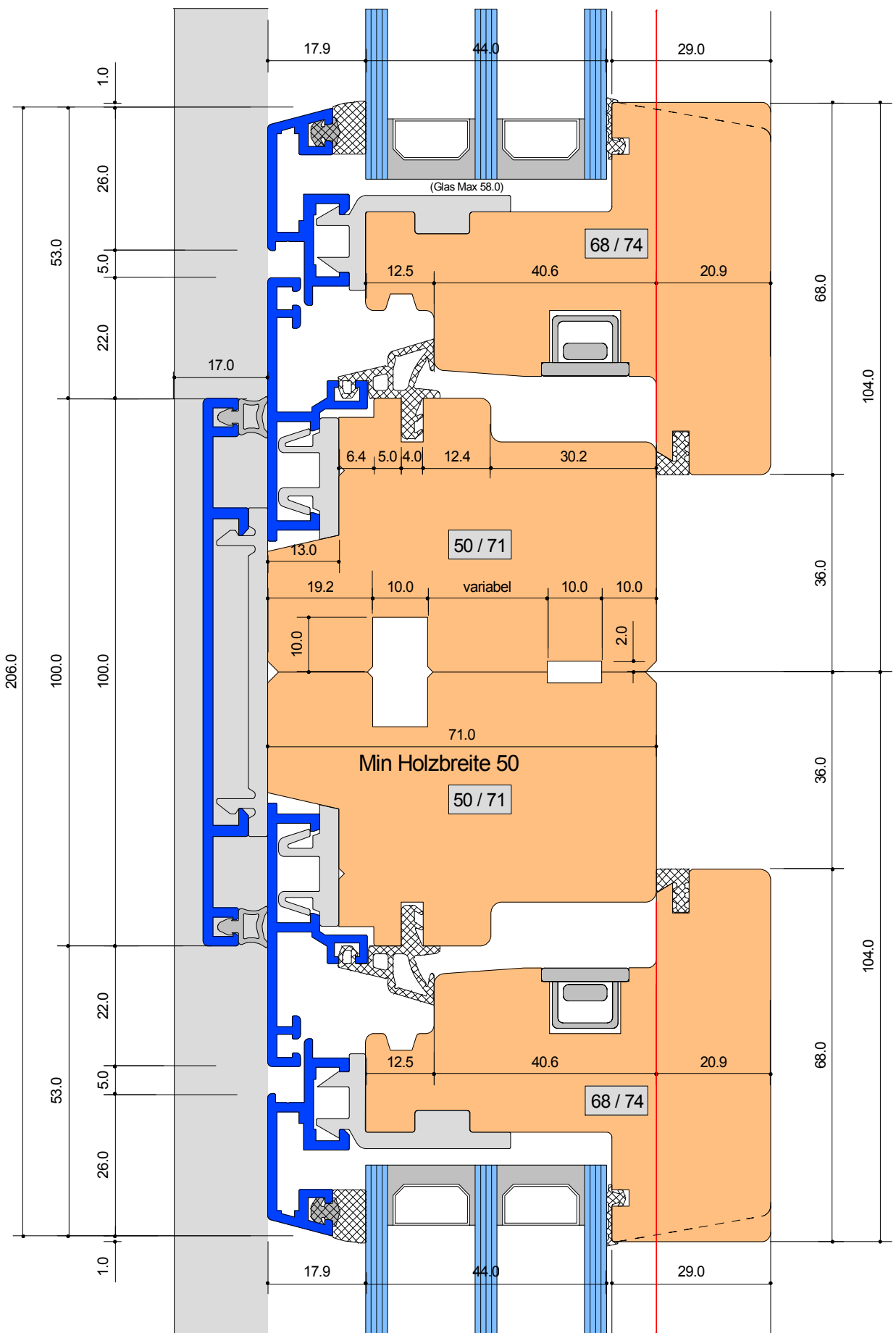

# SYSTEM: M-3 71-74

Kombinationszusammenbau mit Nut + Feder

Detail-Nr :	M -3	D=405
-------------	------	-------

Ersteller: Adi von Euw  
 Datum: 27.10.15  
 Revidiert:



Von Euw Fenster AG  
 Schoosstrasse 2  
 6418 Rothenthurm

Tel 041 839 80 50  
 Fax 041 839 80 60  
 mail info@voneuw.ch

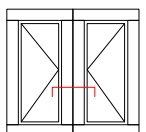

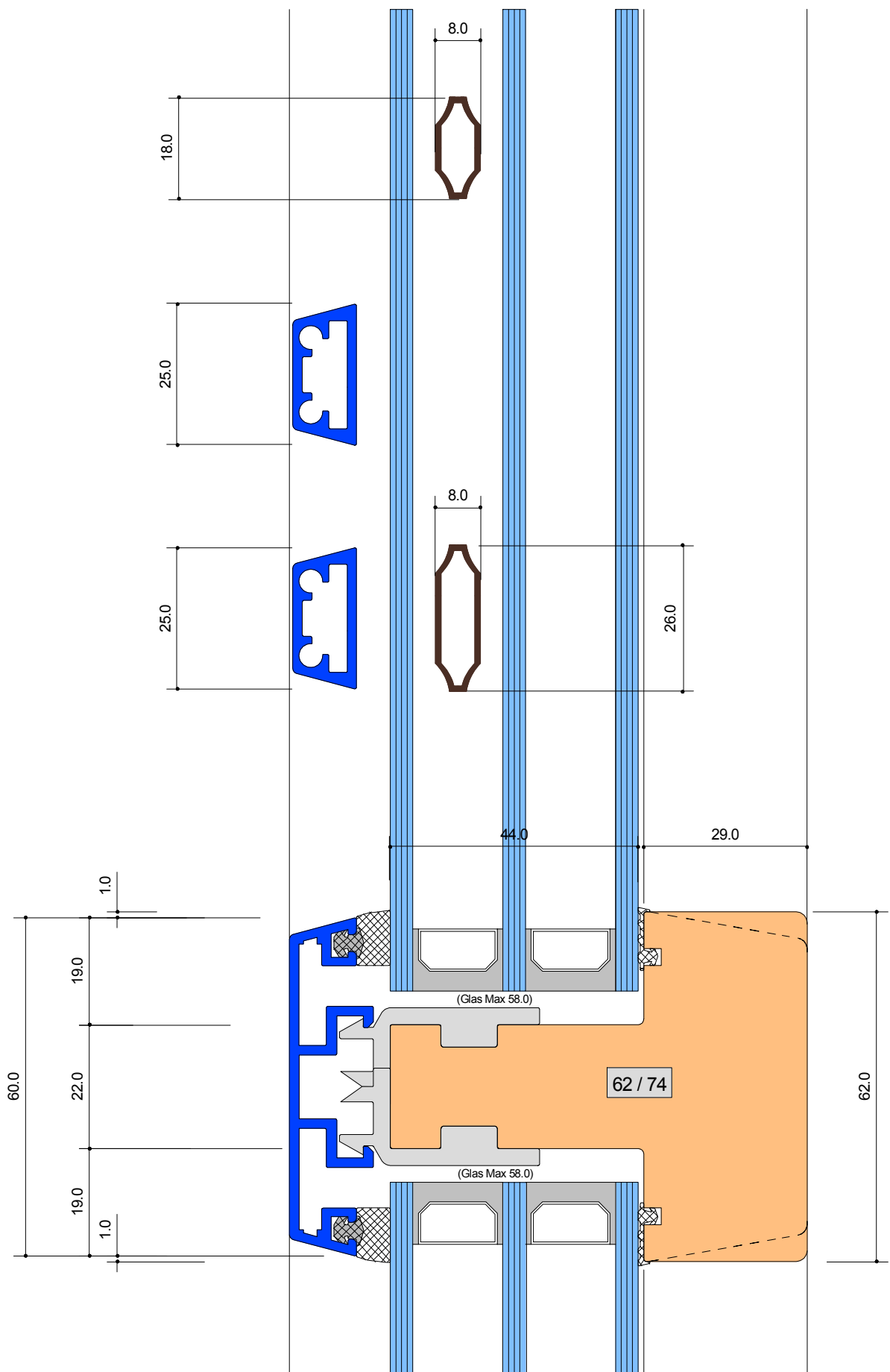

## SYSTEM: M-3 71-74

Sprossen glastrennend 62 mm Alu 60 mm  
 Vorgesetzte Alu-Spr. 25 mm +Zw.Glas Sprosse 26 mm  
 Vorgesetzte Alu-Spr. 25 mm  
 Zwischenglas -Sprosse 18 mm

Detail-Nr :	M -3	D=601
-------------	------	-------



Von Euw Fenster AG  
 Schoosstrasse 2  
 6418 Rothenthurm

Tel 041 839 80 50  
 Fax 041 839 80 60  
 mail info@voneuw.ch

Ersteller: Adi von Euw  
 Datum: 27.10.15  
 Revidiert:

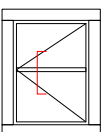



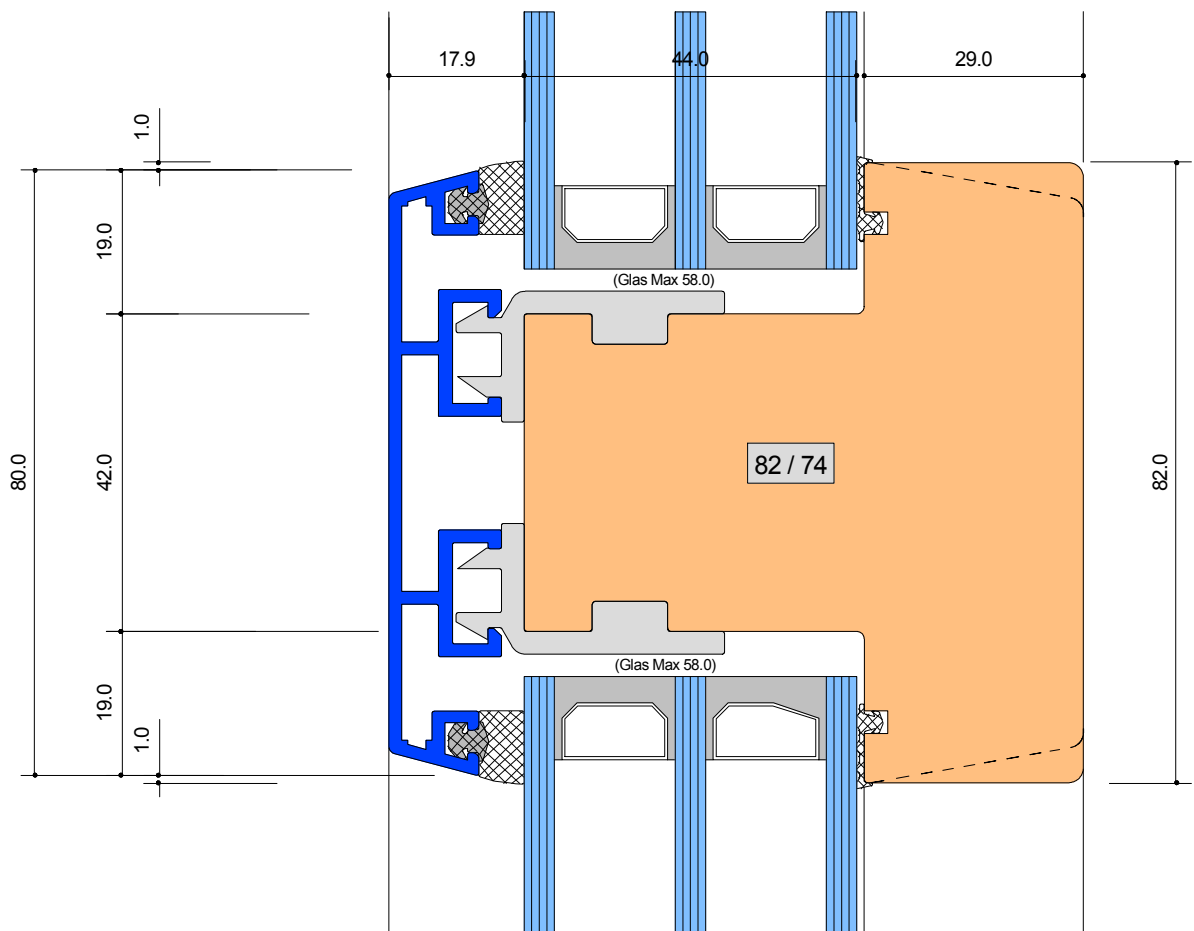

**SYSTEM: M-3 71-74**

Sprossen glastrennend 80 mm

Detail-Nr :	M -3	D=602
-------------	------	-------



Von Euw Fenster AG  
Schoosstrasse 2  
6418 Rothenthurm

Tel 041 839 80 50  
Fax 041 839 80 60  
mail info@voneuw.ch

Ersteller: Adi von Euw  
Datum: 27.10.15  
Revidiert:

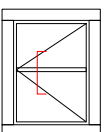

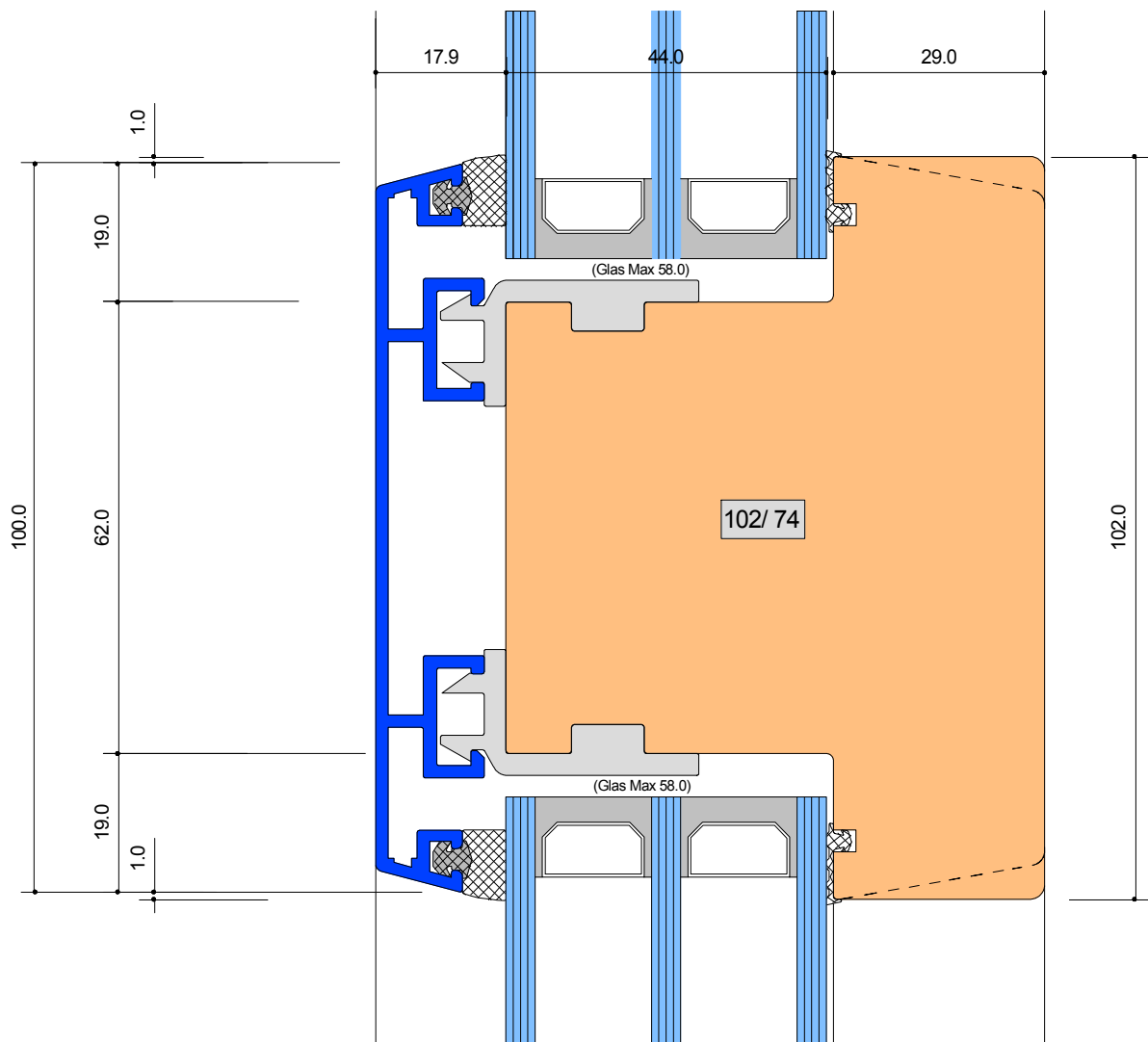

**SYSTEM: M-3 71-74**

Sprossen glastrennend 100 mm

Detail-Nr :	M -3	D=603
-------------	------	-------



Von Euw Fenster AG  
Schoosstrasse 2  
6418 Rothenthurm

Tel 041 839 80 50  
Fax 041 839 80 60  
mail info@voneuw.ch

Ersteller: Adi von Euw  
Datum: 27.10.15  
Revidiert:

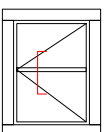

N69202 0.353 g/m1  
 X1-ST 045-008 (roh+eloxiert)  
 Fräsung 30.0 x 5.0 mm  
 Abstand 125/25x250/125

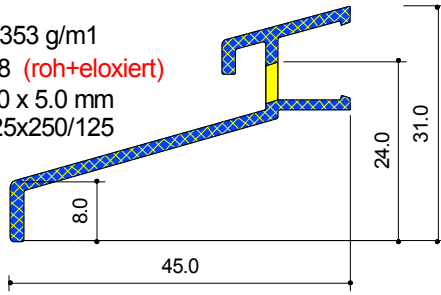

N74777 0.378 g/m1  
 X1-ST 045-013 (roh+eloxiert)  
 Fräsung 30.0 x 5.0 mm  
 Abstand 125/25x250/125

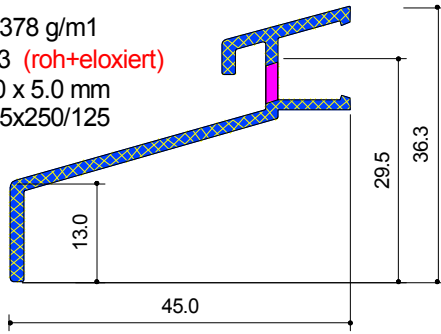

N70586 0.445 g/m1  
 X1-ST 065-008 (roh+eloxiert)  
 Fräsung 30.0 x 5.0 mm  
 Abstand 125/25x250/125

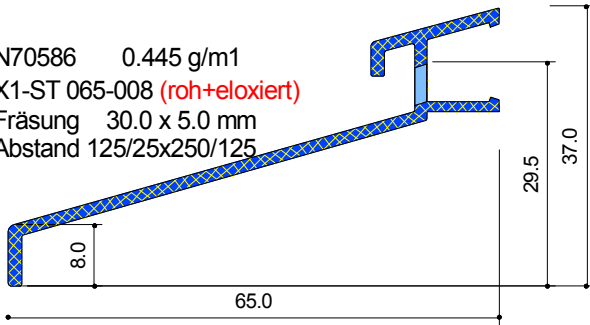

N74260 0.561 g/m1  
 X1-ST 065-030 (eloxiert)  
 Fräsung 30.0 x 5.0 mm  
 Abstand 125/25x250/125

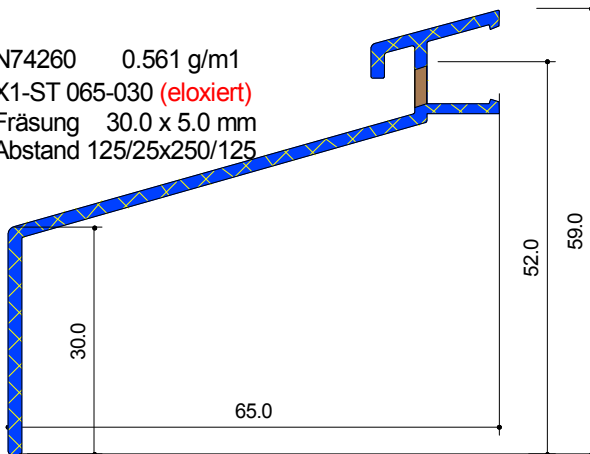

N70584 0.295 g/m1  
 X1-ST 017-021 (eloxiert)  
 Fräsung 30.0 x 5.0 mm  
 Abstand 125/25x250/125

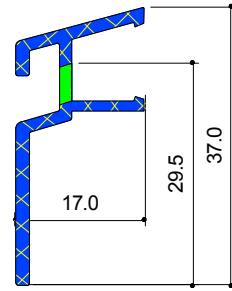

N70585 0.393 g/m1  
 X1-ST 017-041 (eloxiert)  
 Fräsung 30.0 x 5.0 mm  
 Abstand 125/25x250/125

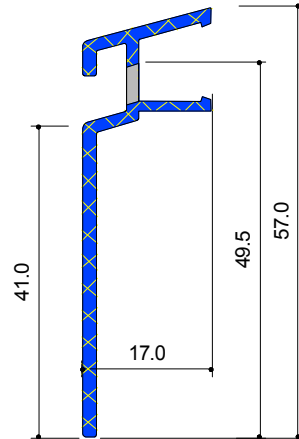

N74261 0.620 g/m1  
 X1-ST 017-084 (eloxiert)  
 Fräsung 30.0 x 5.0 mm  
 Abstand 125/25x250/125

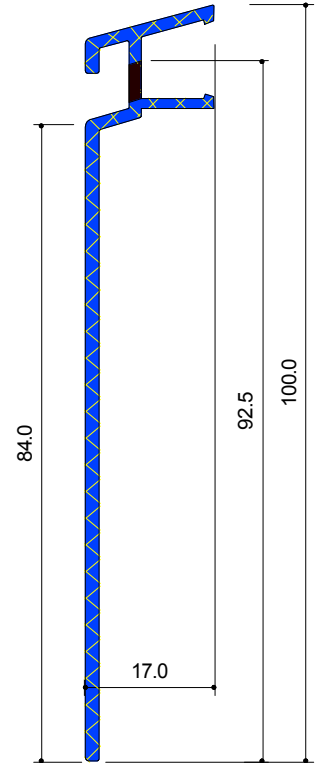

L49108 0.450 g/m1  
 M1-GR 038-18 Roll (roh)  
 Fräsung 30.0 x 5.0 mm  
 Abstand 50/32x200/50

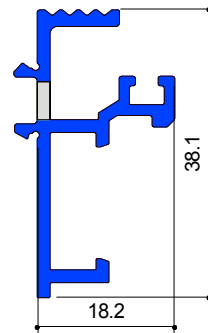

SYSTEM: \*H, L, M, R\*

Steckteil-Profilübersicht

Detail-Nr : A-1 D=100



Von Euw Fenster AG  
 Schoosstrasse 2  
 6418 Rothenthurm

Tel 041 839 80 50  
 Fax 041 839 80 60  
 mail info@voneuw.ch

Ersteller: Adi von Euw  
 Datum: 28.03.17

- Alu \*roh\* (Lager)
- Alu \*farblos elox.\* (Lager)
- Alu \*Roh + farblos elox.\* (Lager)