

Holz-Metallfenster

System : M-2 67/70

„top class“

Vermasste Standard-Details

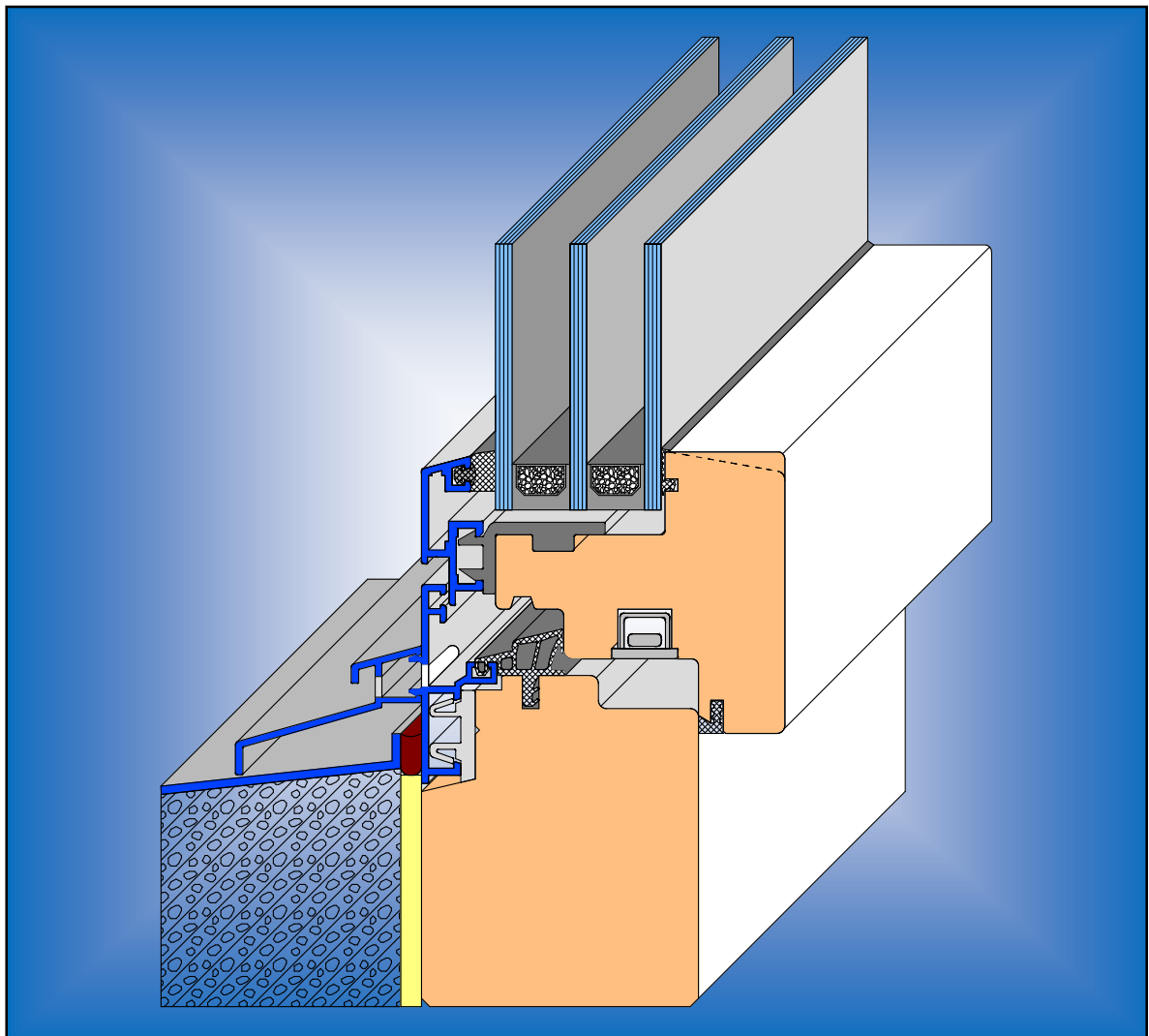

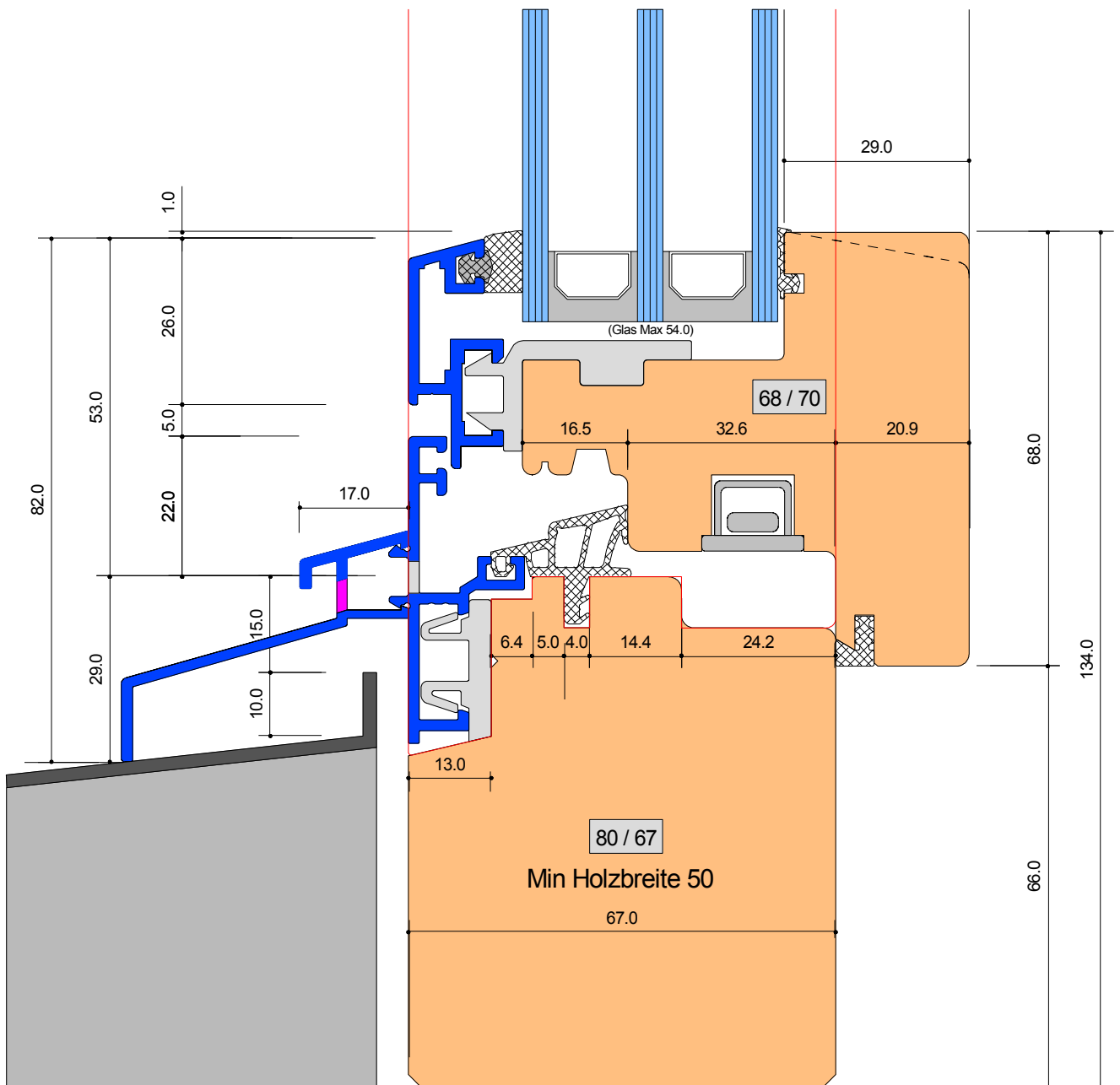

SYSTEM: M-2 67-70

Anschluss unten mit Alu Fensterbank
Wetterschenkel Typ RWS 045-013

Detail-Nr :	M -2	D=001
-------------	------	-------



Von Euw Fenster AG
Schoosstrasse 2
6418 Rothenthurm

Tel 041 839 80 50
Fax 041 839 80 60
mail info@voneuw.ch

Ersteller: Adi von Euw
Datum: 16.06.14
Revidiert:

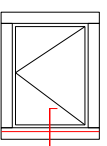

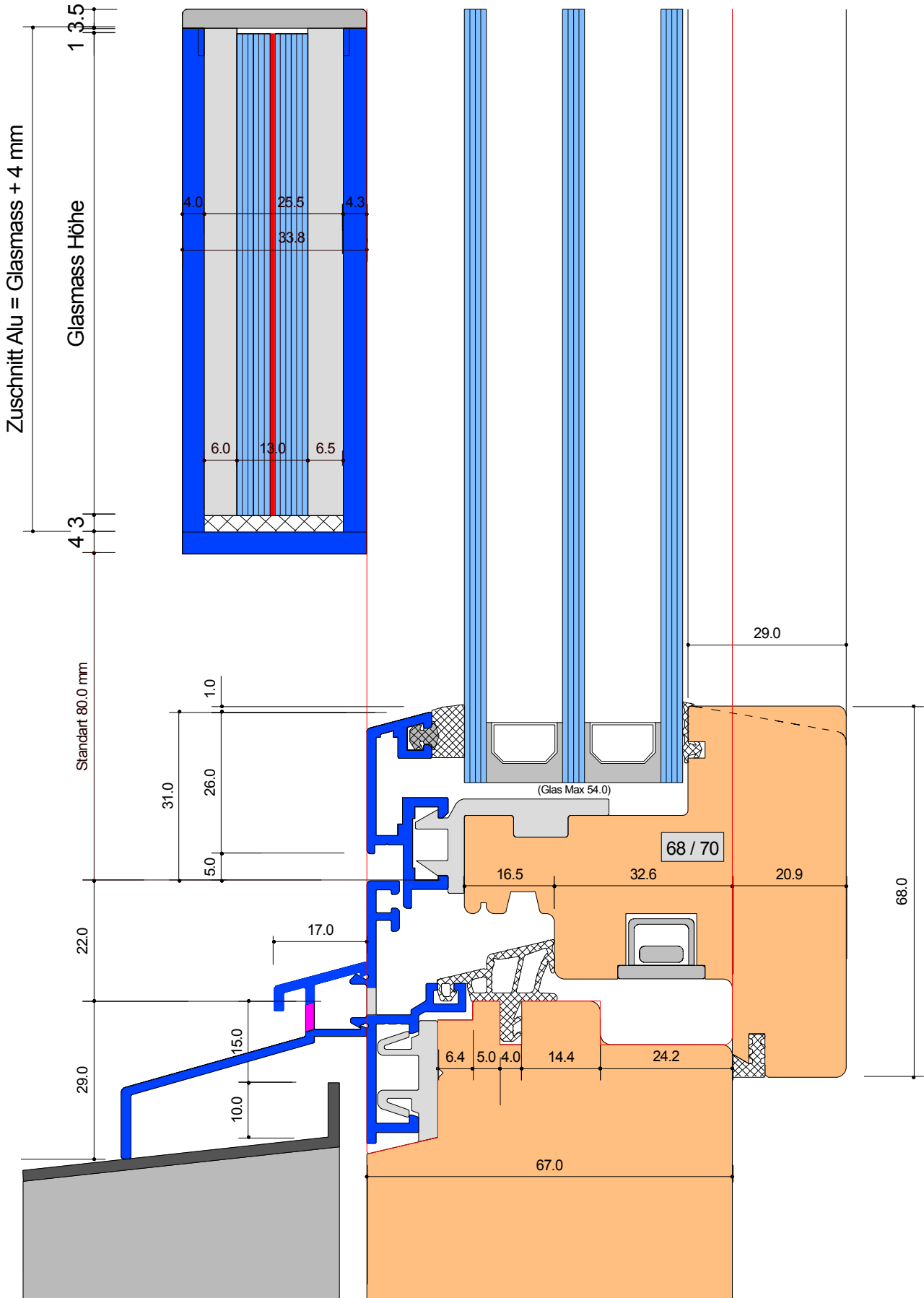

SYSTEM: M-2 67-70

Anschluss unten mit Alu Fensterbank
 Wetterschenkel Typ RWS 045-013
 mit Brüstungsglas VSG 12-2

Detail-Nr : M-2 D=001G



Von Euw Fenster AG
 Schoosstrasse 2
 6418 Rothenthurm

Tel 041 839 80 50
 Fax 041 839 80 60
 mail info@voneuw.ch

Ersteller: Adi von Euw
 Datum: 23.03.17
 Revidiert:

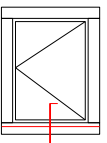

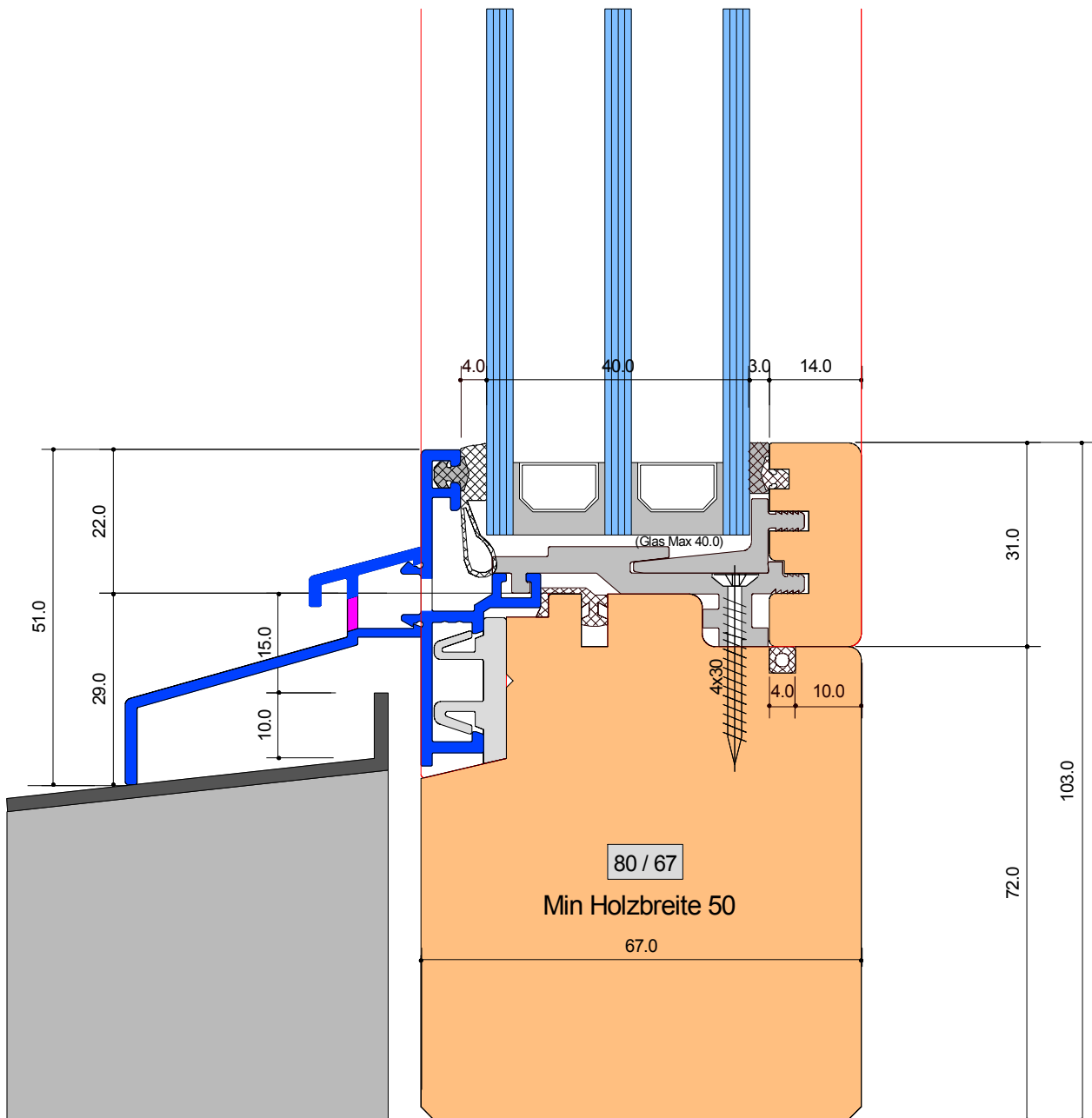

SYSTEM: M-2 67-70

Fest i.R. verglast
Wetterschenkel Typ RWS 045-013

Detail-Nr :	M -2	D=001R
-------------	------	--------



Von Euw Fenster AG
Schoosstrasse 2
6418 Rothenthurm

Tel 041 839 80 50
Fax 041 839 80 60
mail info@voneuw.ch

Ersteller: Adi von Euw
Datum: 23.11.16
Revidiert:

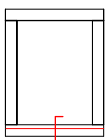

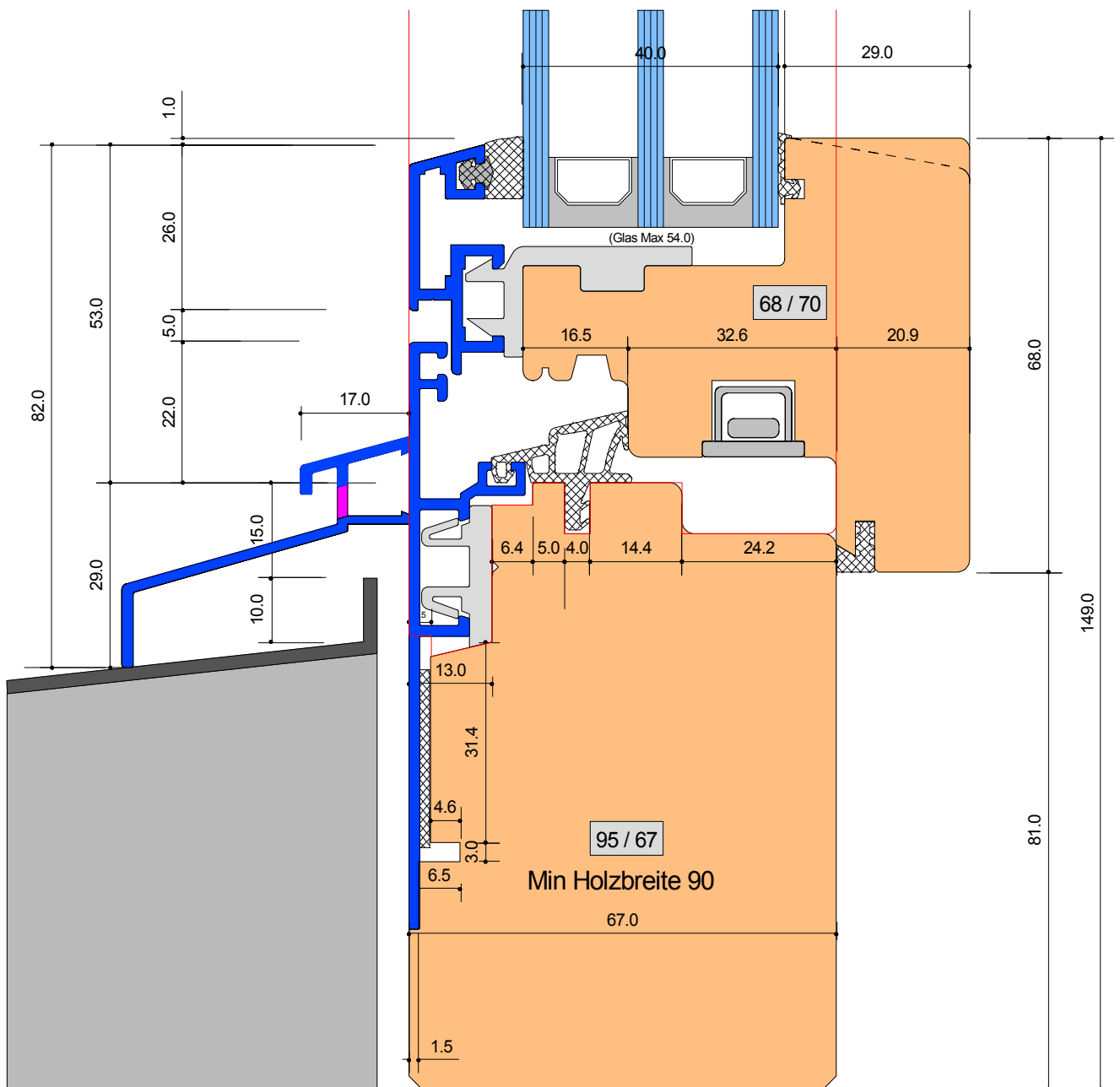

SYSTEM: M-2 67-70

Anschluss unten mit Alu Fensterbank
 Wetterschenkel Typ RWS 045-013
 mit Spezialprofil 92 mm

Detail-Nr :	M-2	D=001Z
-------------	-----	--------



Von Euw Fenster AG
 Schoosstrasse 2
 6418 Rothenthurm

Tel 041 839 80 50
 Fax 041 839 80 60
 mail info@voneuw.ch

Ersteller: Adi von Euw
 Datum: 16.06.14
 Revidiert:

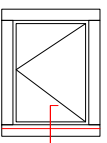

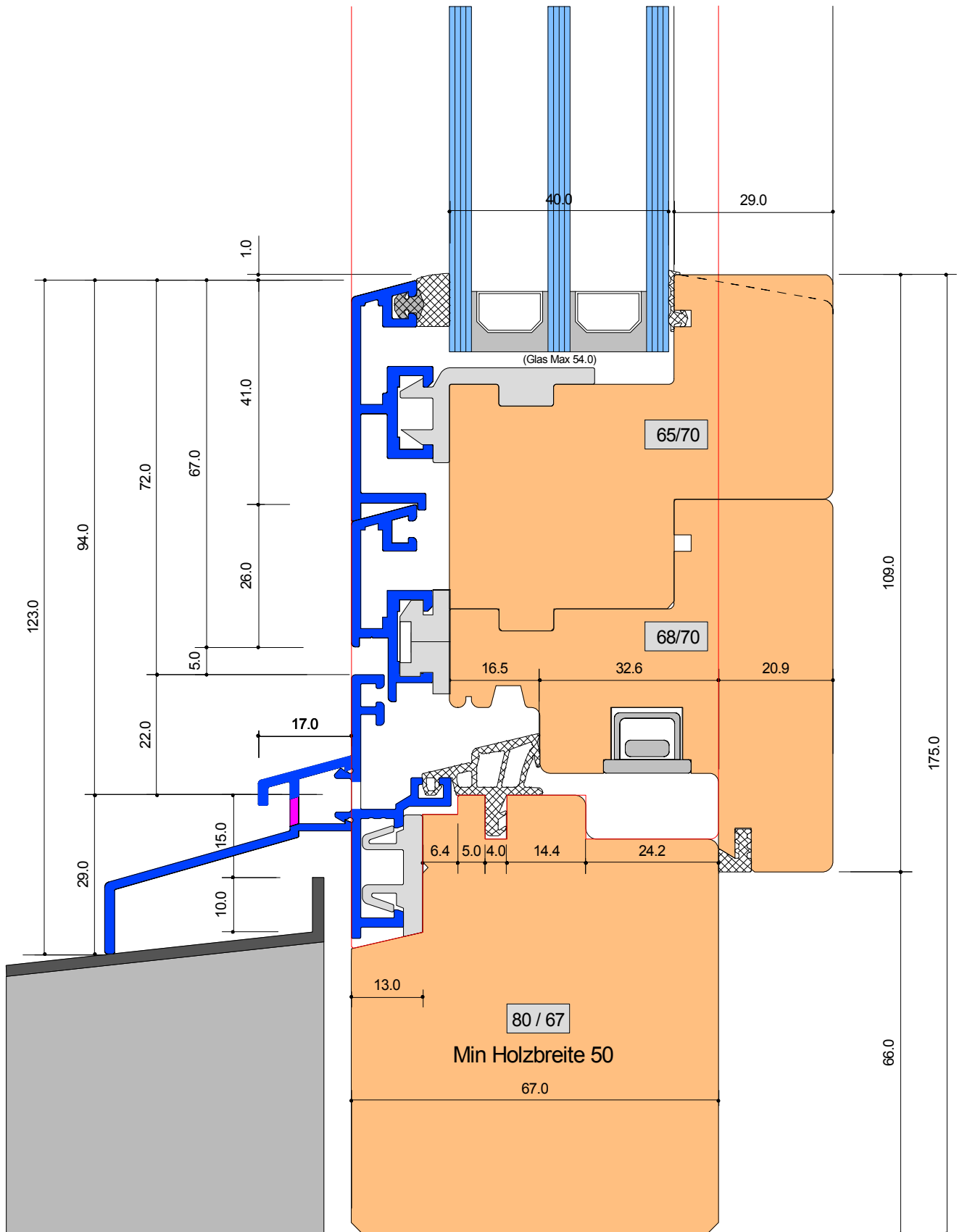

SYSTEM: M-2 67-70

Anschluss unten BT 109 mm
Wetterschenkel Typ RWS 045-013

Detail-Nr :	M-2	D=005
-------------	-----	-------



Von Euw Fenster AG
Schoosstrasse 2
6418 Rothenthurm

Tel 041 839 80 50
Fax 041 839 80 60
mail info@voneuw.ch

Ersteller: Adi von Euw
Datum: 16.06.14
Revidiert:

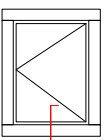

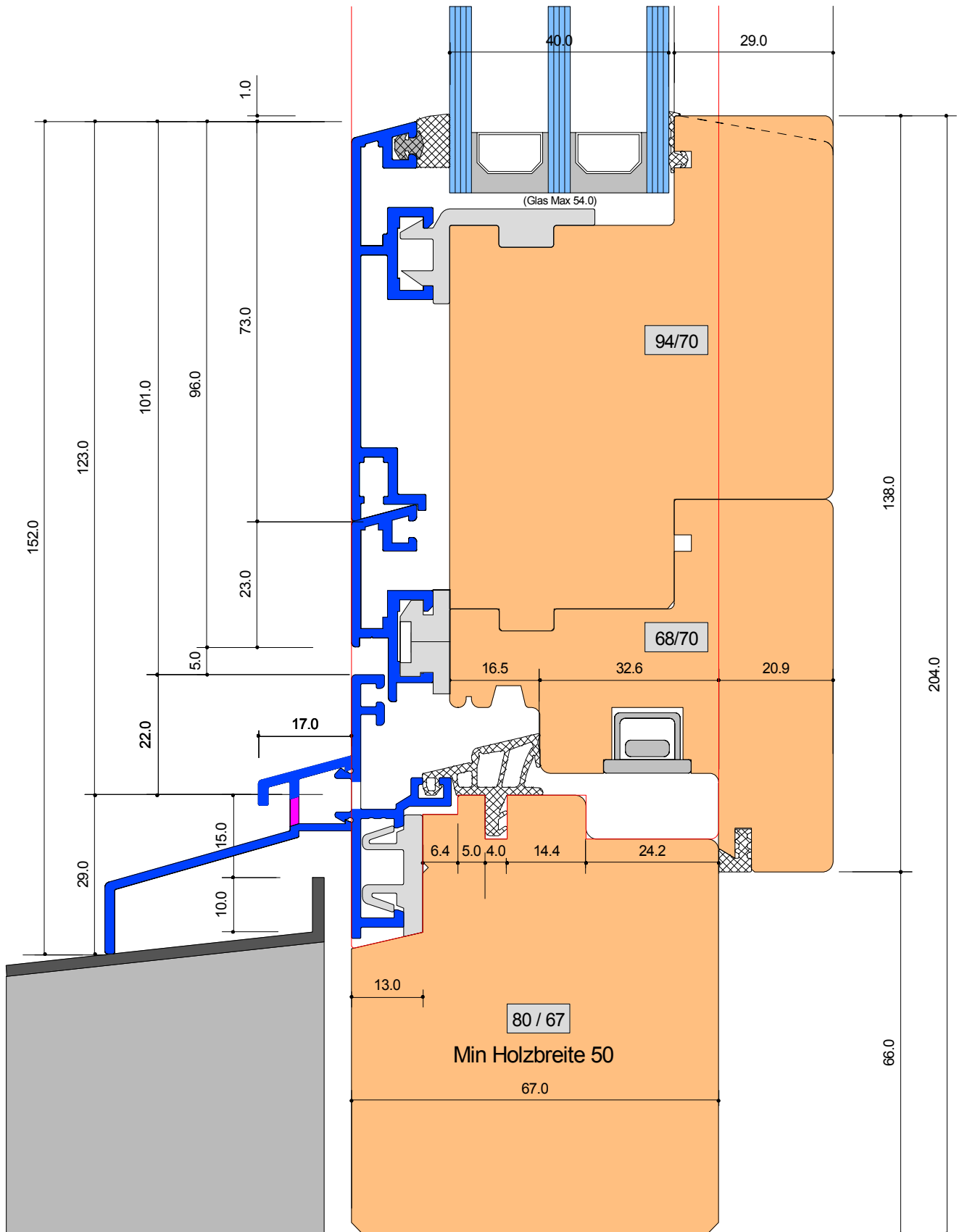

SYSTEM: M-2 67-70

Anschluss unten BT 138 mm
Wetterschenkel Typ RWS 045-013

Detail-Nr :	M -2	D=006
-------------	------	-------



Von Euw Fenster AG
Schoosstrasse 2
6418 Rothenthurm

Tel 041 839 80 50
Fax 041 839 80 60
mail info@voneuw.ch

Ersteller: Adi von Euw
Datum: 16.06.14
Revidiert:

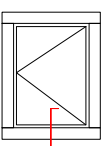

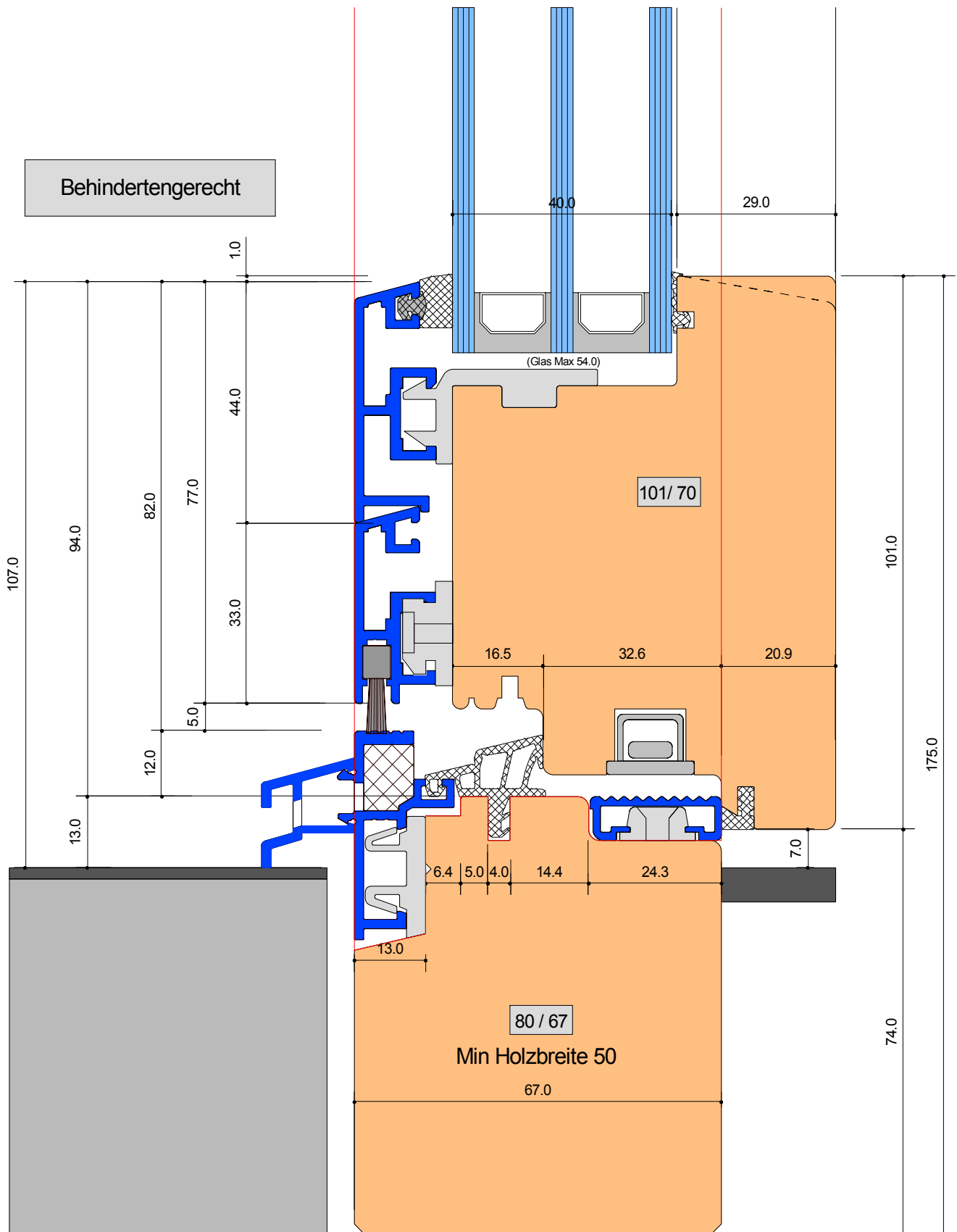

SYSTEM: M-2 67-70

Anschluss unten Rollstuhlgängig 101 mm
 Mit Flügelbreite 101 mm (-8.0)
 Grundprofil M1-GR 038-18 Roll / Steckteil Variabel

Detail-Nr :	M-2	D=022
-------------	-----	-------



Von Euw Fenster AG
 Schoosstrasse 2
 6418 Rothenthurm

Tel 041 839 80 50
 Fax 041 839 80 60
 mail info@voneuw.ch

Ersteller: Adi von Euw
 Datum: 16.06.14
 Revidiert: 22.10.19

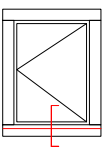

Behindertengerecht

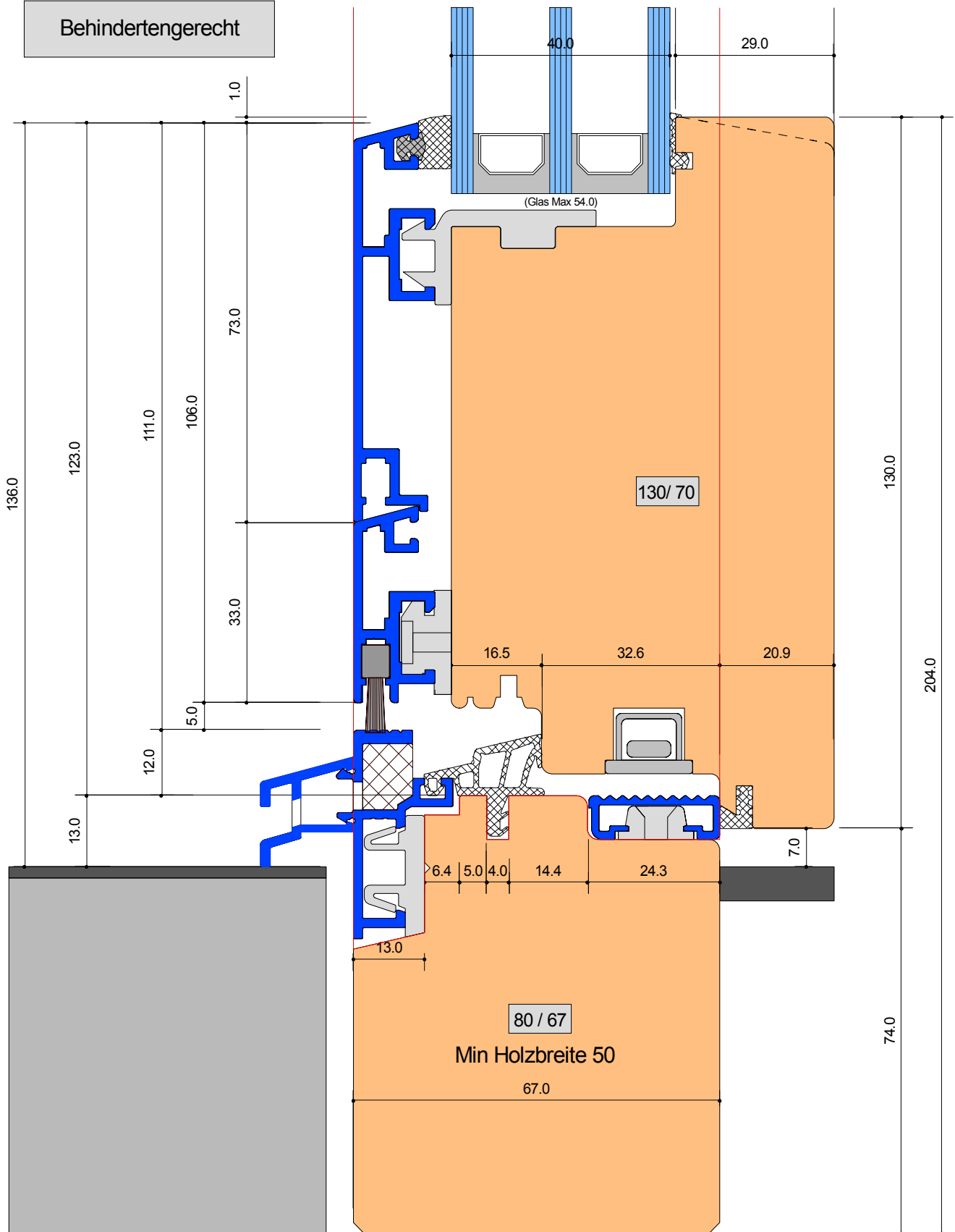

SYSTEM: M-2 67-70

Anschluss unten Rollstuhlgängig 130 mm
 Mit Flügelbreite 130 mm (-8.0)
 Grundprofil M1-GR 038-18 Roll / Steckteil Variabel

Detail-Nr :	M -2	D=023
-------------	------	-------



Von Euw Fenster AG
 Von Euw Fenster AG
 Schoosstrasse 2
 6418 Rothenthurm

Tel 041 839 80 50
 Fax 041 839 80 60
 mail info@voneuw.ch

Ersteller: Adi von Euw
 Datum: 16.06.14
 Revidiert: 22.10.19

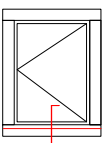

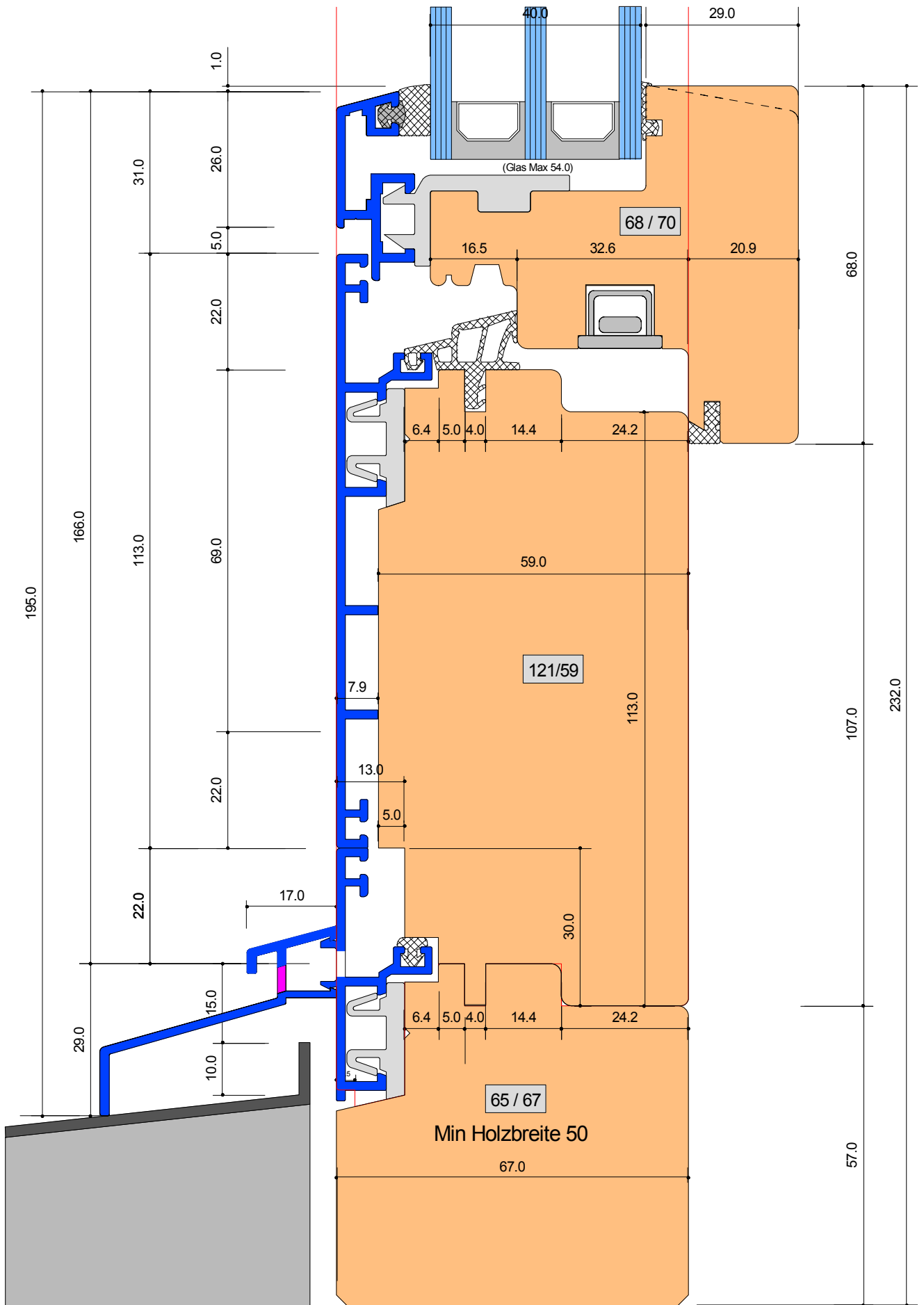

SYSTEM: M-2 67-70

Anschluss unten Standard mit Einleimer
Wetterschenkel Typ RWS 045-013

Detail-Nr :	M-2	D=031
-------------	-----	-------



Von Euw Fenster AG
Schoosstrasse 2
6418 Rothenthurm

Tel 041 839 80 50
Fax 041 839 80 60
mail info@voneuw.ch

Ersteller: Adi von Euw
Datum: 16.06.14
Revidiert:

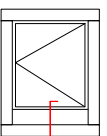

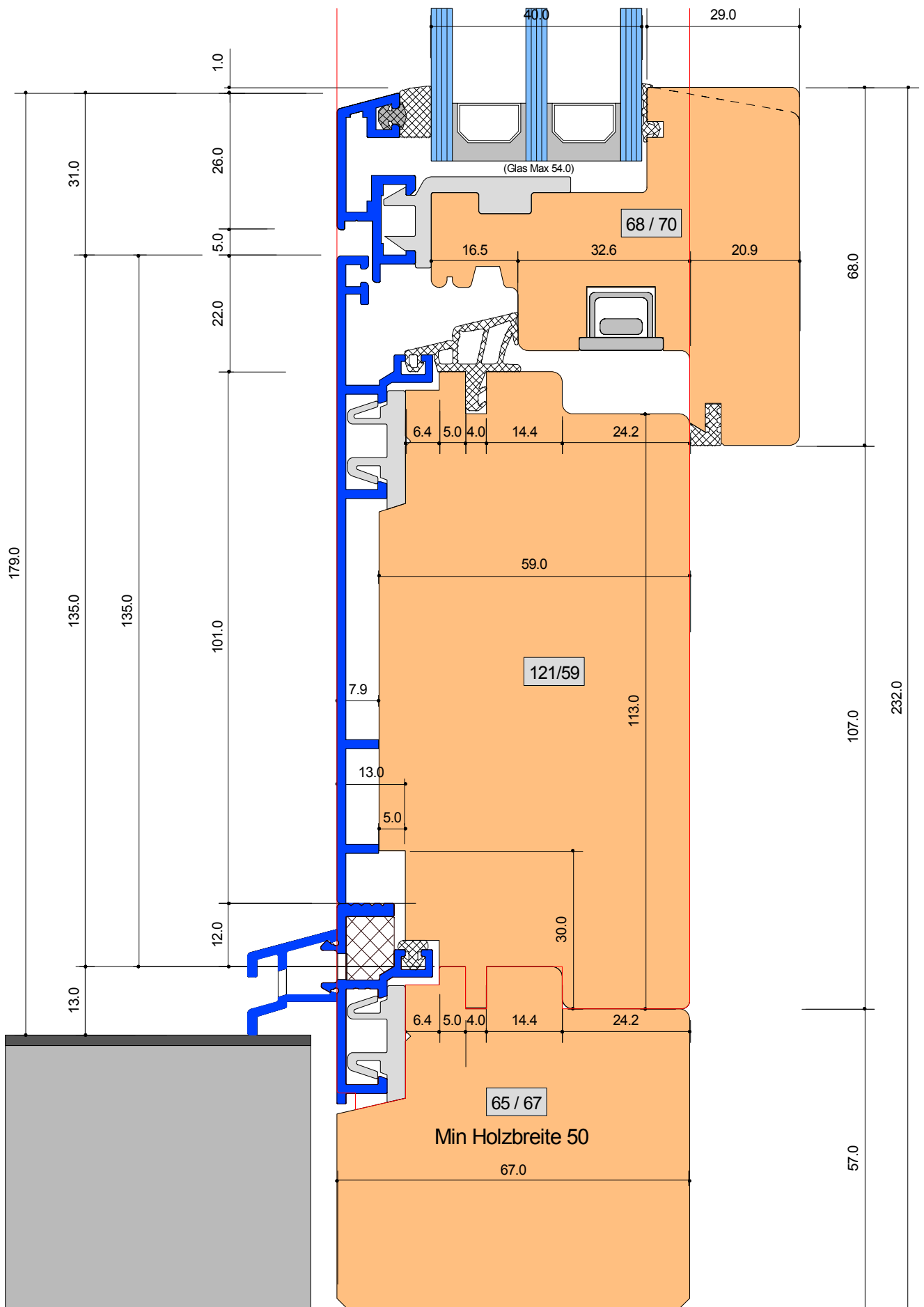

SYSTEM: M-2 67-70

Anschluss unten Rollstuhlgängig mit Einleimer

Grundprofil M1-GR 038-18 Roll / Steckteil Variabel

Detail-Nr :	M-2	D=035
-------------	-----	-------



Von Euw Fenster AG
Schoosstrasse 2
6418 Rothenthurm

Tel 041 839 80 50
Fax 041 839 80 60
mail info@voneuw.ch

Ersteller: Adi von Euw
Datum: 16.06.14
Revidiert: 22.10.19

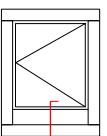

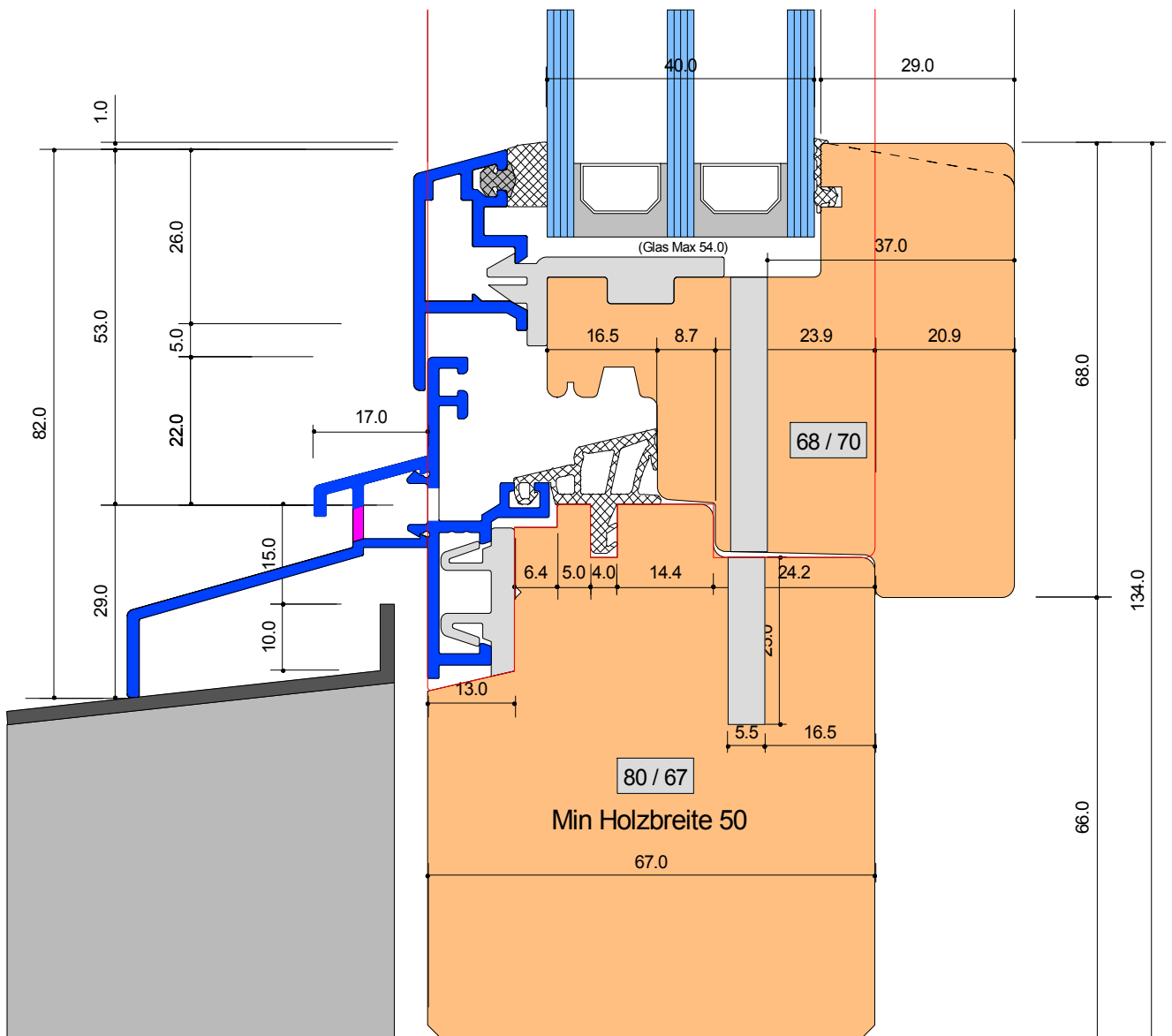

SYSTEM: M-2 67-70

Anschluss unten mit Alu Fensterbank
 Wetterschenkel Typ RWS 045-013
 Fest verglast von aussen eingesetzt Flg 68 mm

Detail-Nr :	M -2	D=041
-------------	------	-------



Von Euw Fenster AG
 Schoosstrasse 2
 6418 Rothenthurm

Tel 041 839 80 50
 Fax 041 839 80 60
 mail info@voneuw.ch

Ersteller: Adi von Euw
 Datum: 16.06.14
 Revidiert:

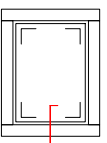

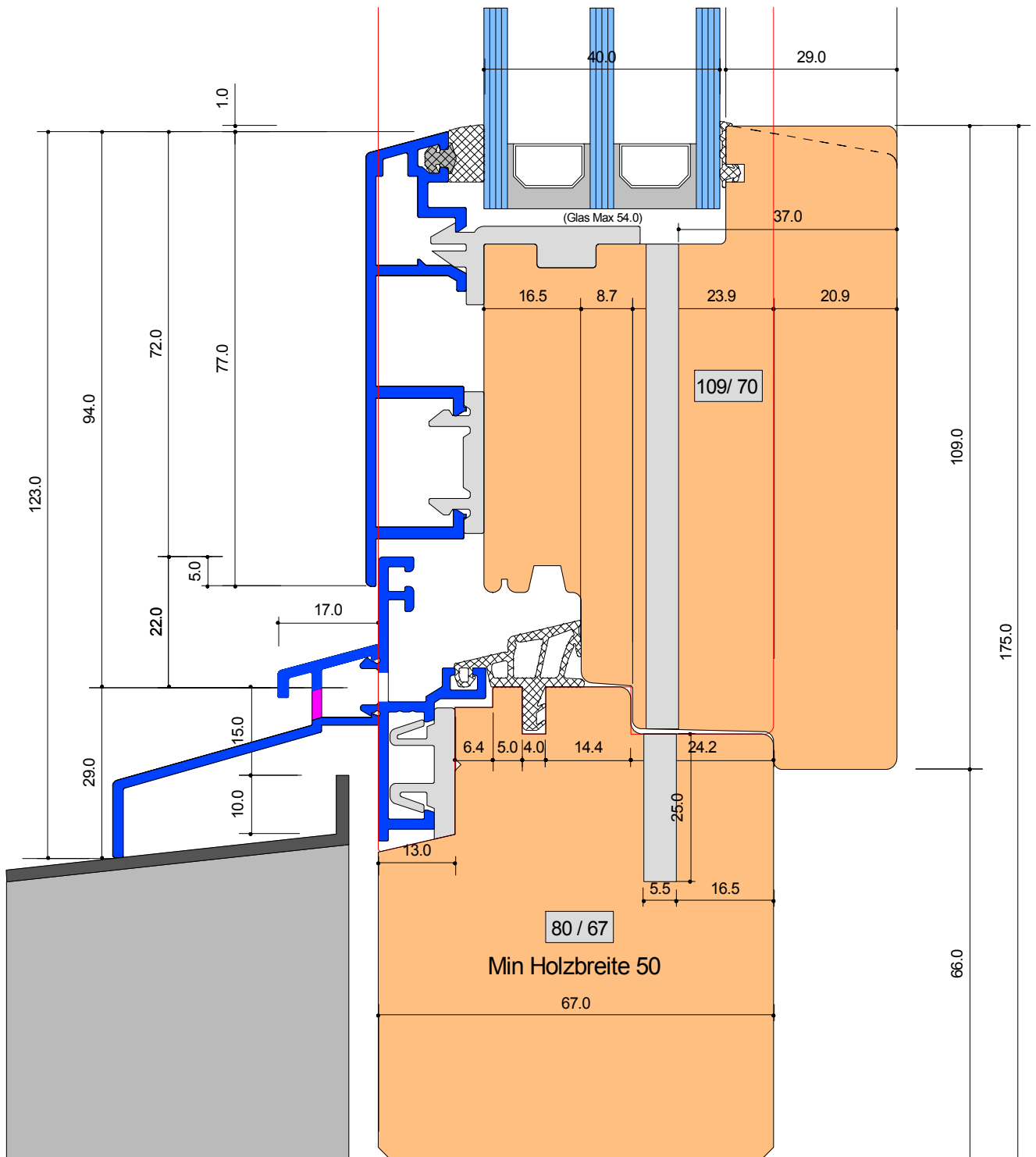

SYSTEM: M-2 67-70

Anschluss unten mit Alu Fensterbank
 Wetterschenkel Typ RWS 045-013
 Fest verglast von aussen eingesetzt Fig 109 mm

Detail-Nr :	M-2	D=042
-------------	-----	-------



Von Euw Fenster AG
 Schoosstrasse 2
 6418 Rothenthurm

Tel 041 839 80 50
 Fax 041 839 80 60
 mail info@voneuw.ch

Ersteller: Adi von Euw
 Datum: 16.06.14
 Revidiert:

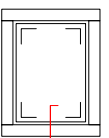

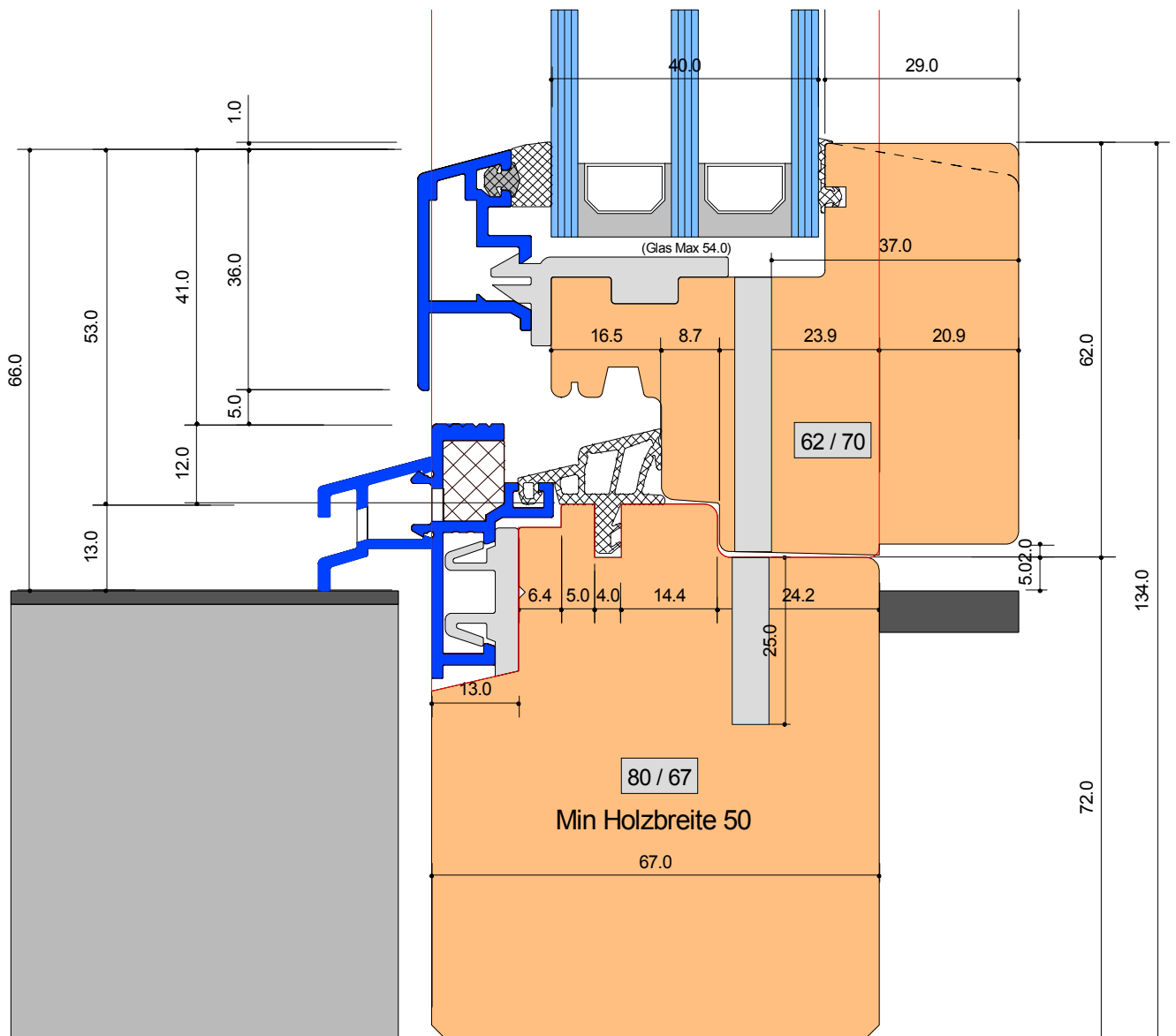

SYSTEM: M-2 67-70

Anschluss unten Rollstuhlgängig
 Standart Flügelbreite 62 mm (-6.0mm) Fest vergl.v.aussen
 Grundprofil M1-GR 038-18 Roll / Steckteil Variabel

Detail-Nr :	M -2	D=045
-------------	------	-------



Von Euw Fenster AG
 Schoosstrasse 2
 6418 Rothenthurm

Tel 041 839 80 50
 Fax 041 839 80 60
 mail info@voneuw.ch

Ersteller: Adi von Euw
 Datum: 16.06.14
 Revidiert: 22.10.19

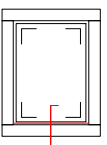

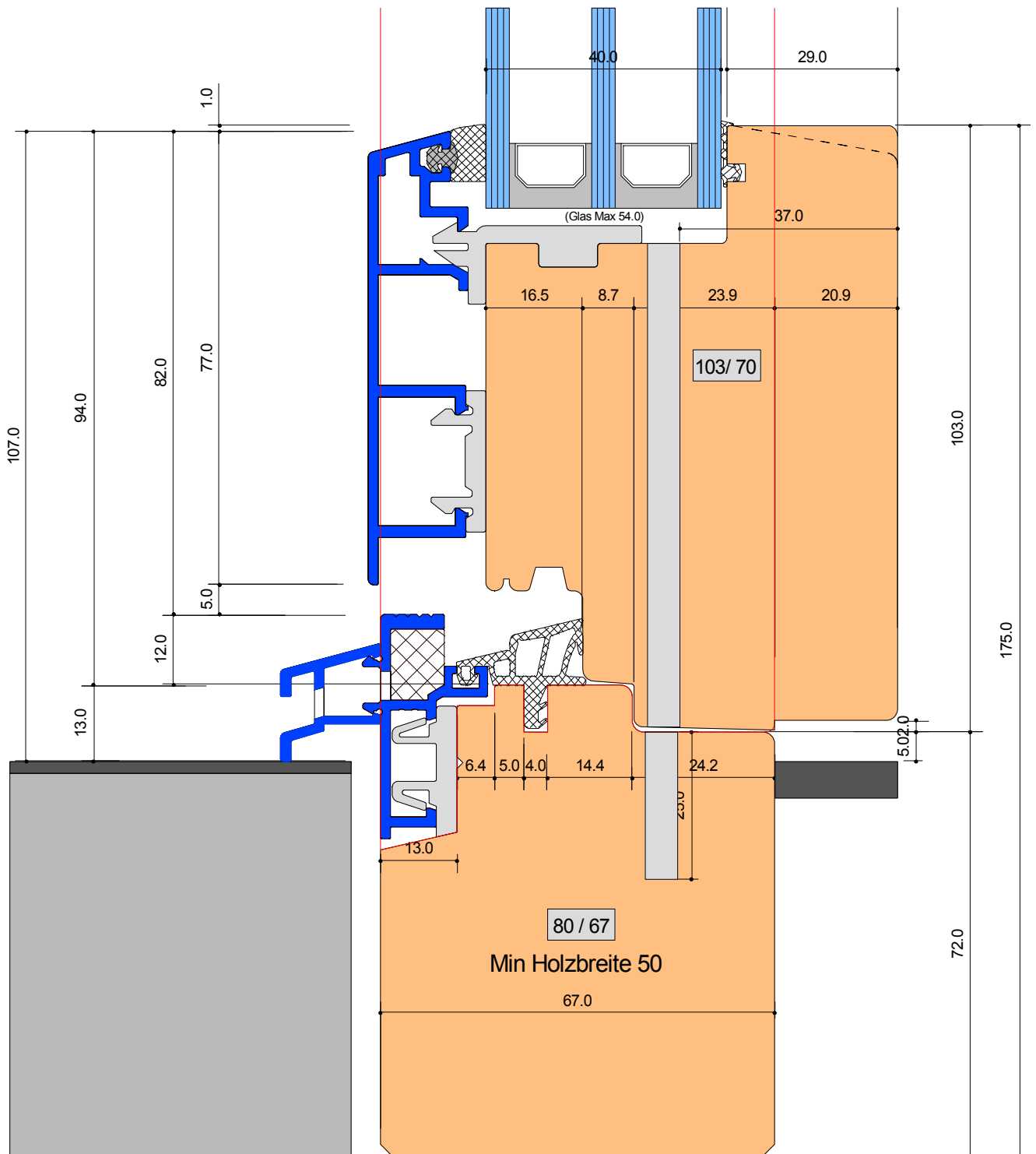

SYSTEM: M-2 67-70

Anschluss unten Rollstuhlgängig
 Mit Flügelbreite 103 (-6.0mm) Fest vergl. v. aussen
 Grundprofil M1-GR 038-18 Roll / Steckteil Variabel

Detail-Nr :	M-2	D=046
-------------	-----	-------



Von Euw Fenster AG
 Schoosstrasse 2
 6418 Rothenthurm

Tel 041 839 80 50
 Fax 041 839 80 60
 mail info@voneuw.ch

Ersteller: Adi von Euw
 Datum: 16.06.14
 Revidiert: 22.10.19

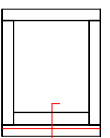

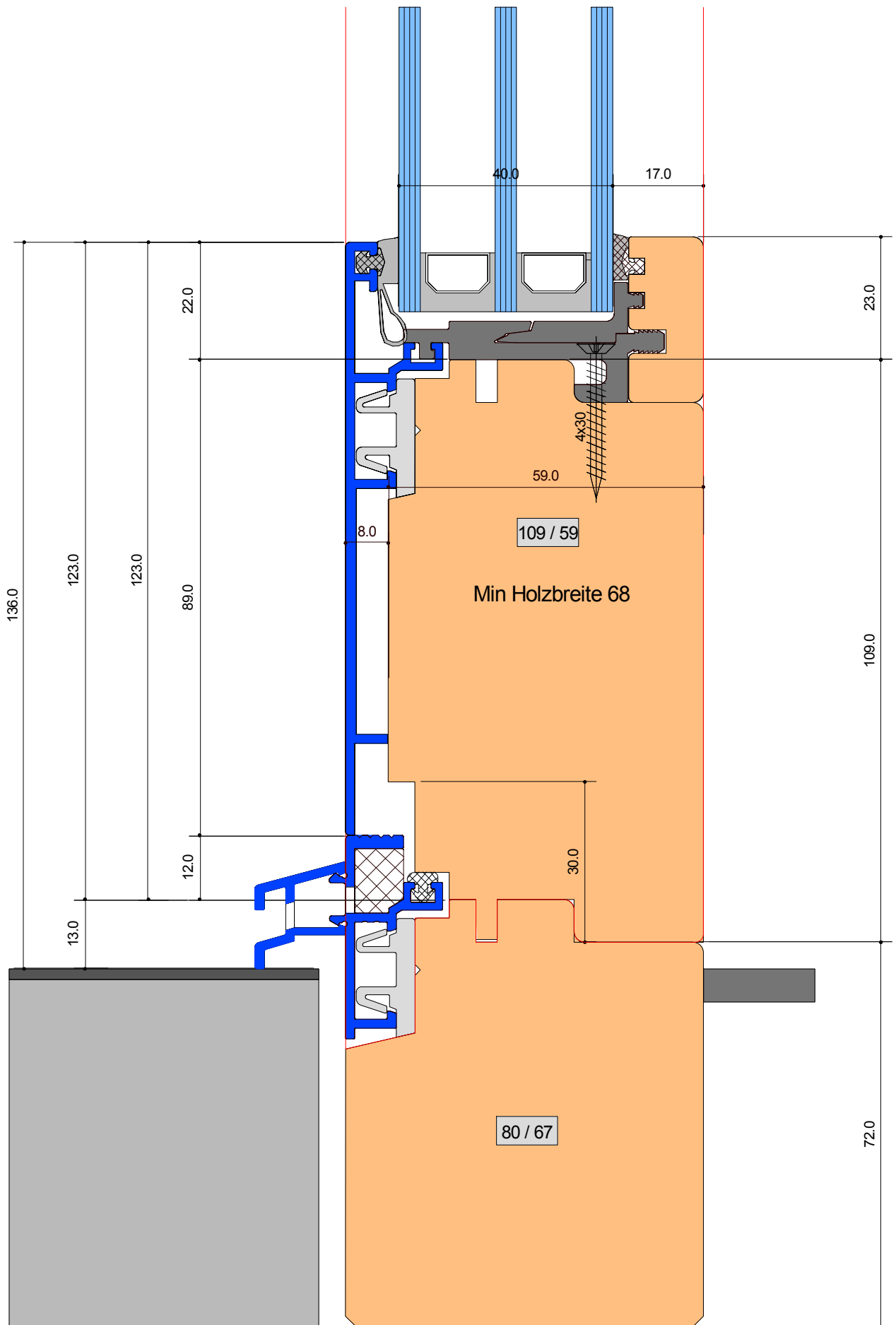

SYSTEM: M-2 67-70

Anschluss unten Rollstuhlgängig
 Fest i.R. verglast mit Einleimer/ paasend zu HT Fr 130 mm
 Grundprofil M1-GR 038-18 Roll / Steckteil Variabel

Detail-Nr :	M -2	D=047
-------------	------	-------



Von Euw Fenster AG
 Schoosstrasse 2
 6418 Rothenthurm

Tel 041 839 80 50
 Fax 041 839 80 60
 mail info@voneuw.ch

Ersteller: Adi von Euw
 Datum: 28.08.17
 Revidiert: 22.10.19

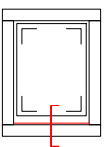

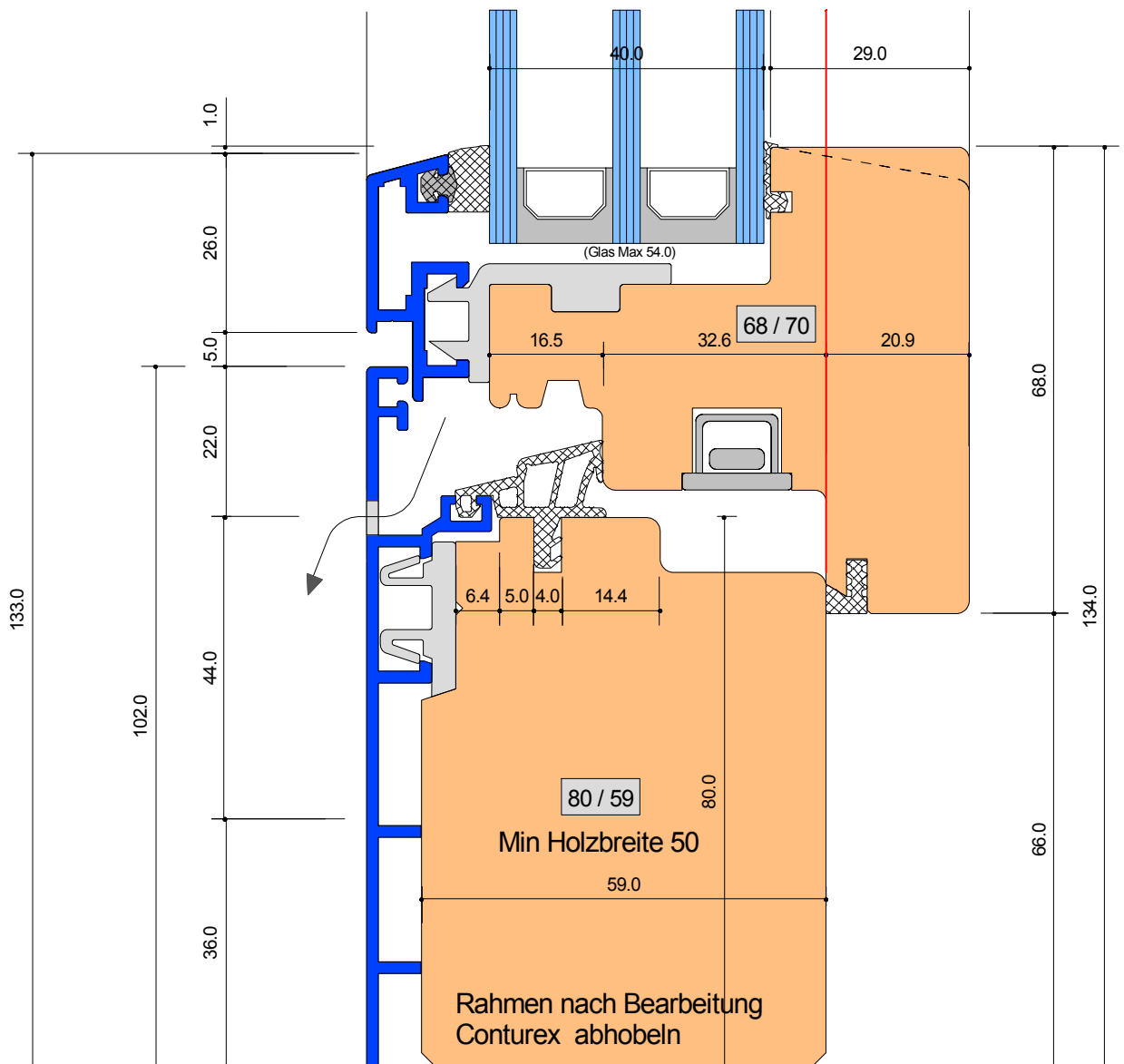

SYSTEM: M-2 67-70

Blockrahmen (mit oder ohne WS) Mit Alu (113 mm)

Detail-Nr :	M -2	D=051
-------------	------	-------



Von Euw Fenster AG
Schoosstrasse 2
6418 Rothenthurm

Tel 041 839 80 50
Fax 041 839 80 60
mail info@voneuw.ch

Ersteller: Adi von Euw
Datum: 16.06.14
Revidiert:

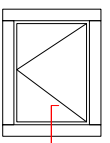

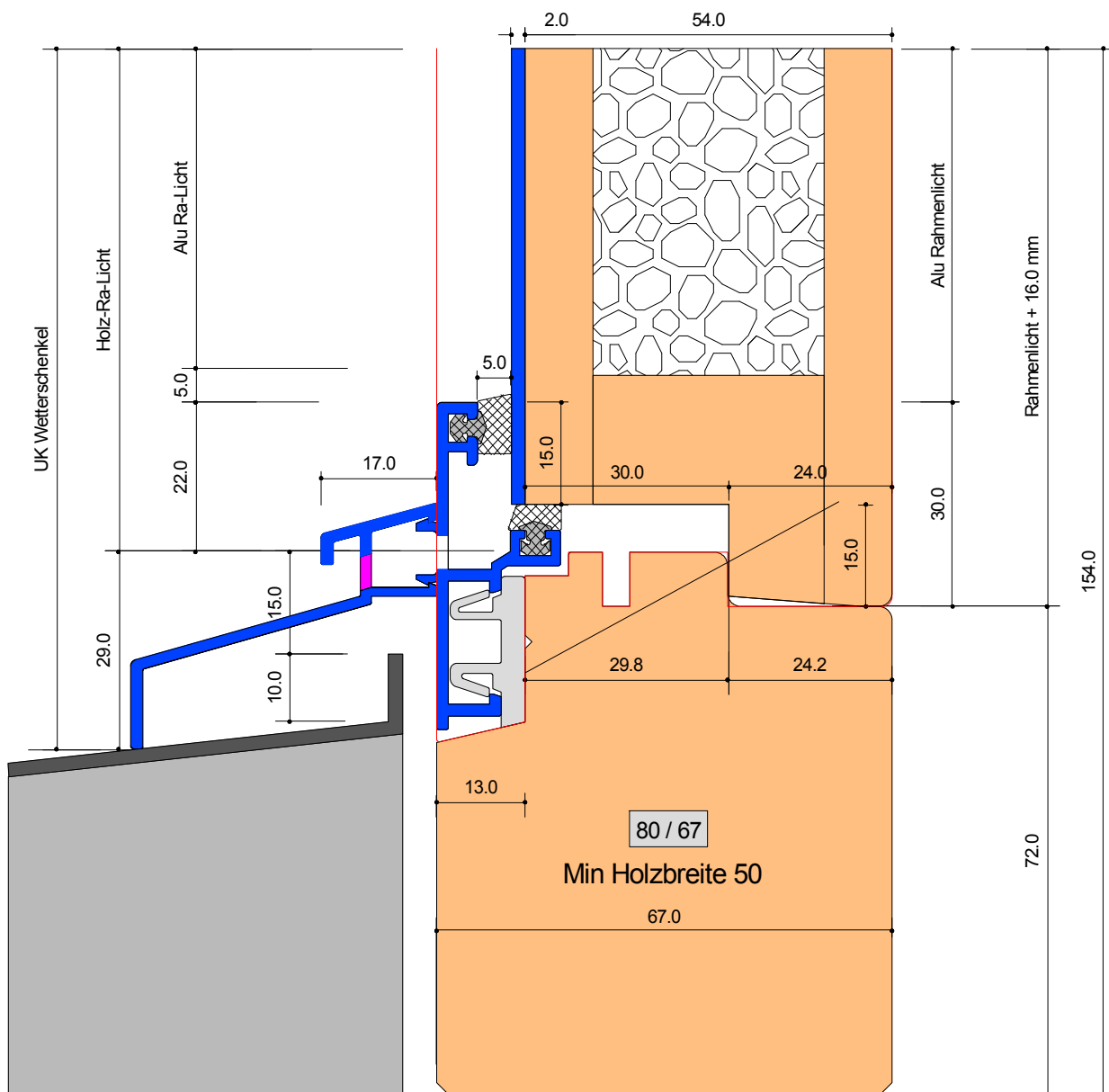

SYSTEM: M-2 67-70

Anschluss unten mit Alu Fensterbank
 Wetterschenkel Typ RWS 045-013
 mit Brüstungseinsatz innen FI-bündig

Detail-Nr :	M -2	D=060
-------------	------	-------



Von Euw Fenster AG
 Schoosstrasse 2
 6418 Rothenthurm

Tel 041 839 80 50
 Fax 041 839 80 60
 mail info@voneuw.ch

Ersteller: Adi von Euw
 Datum: 16.06.14
 Revidiert: 23.01.19

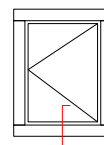

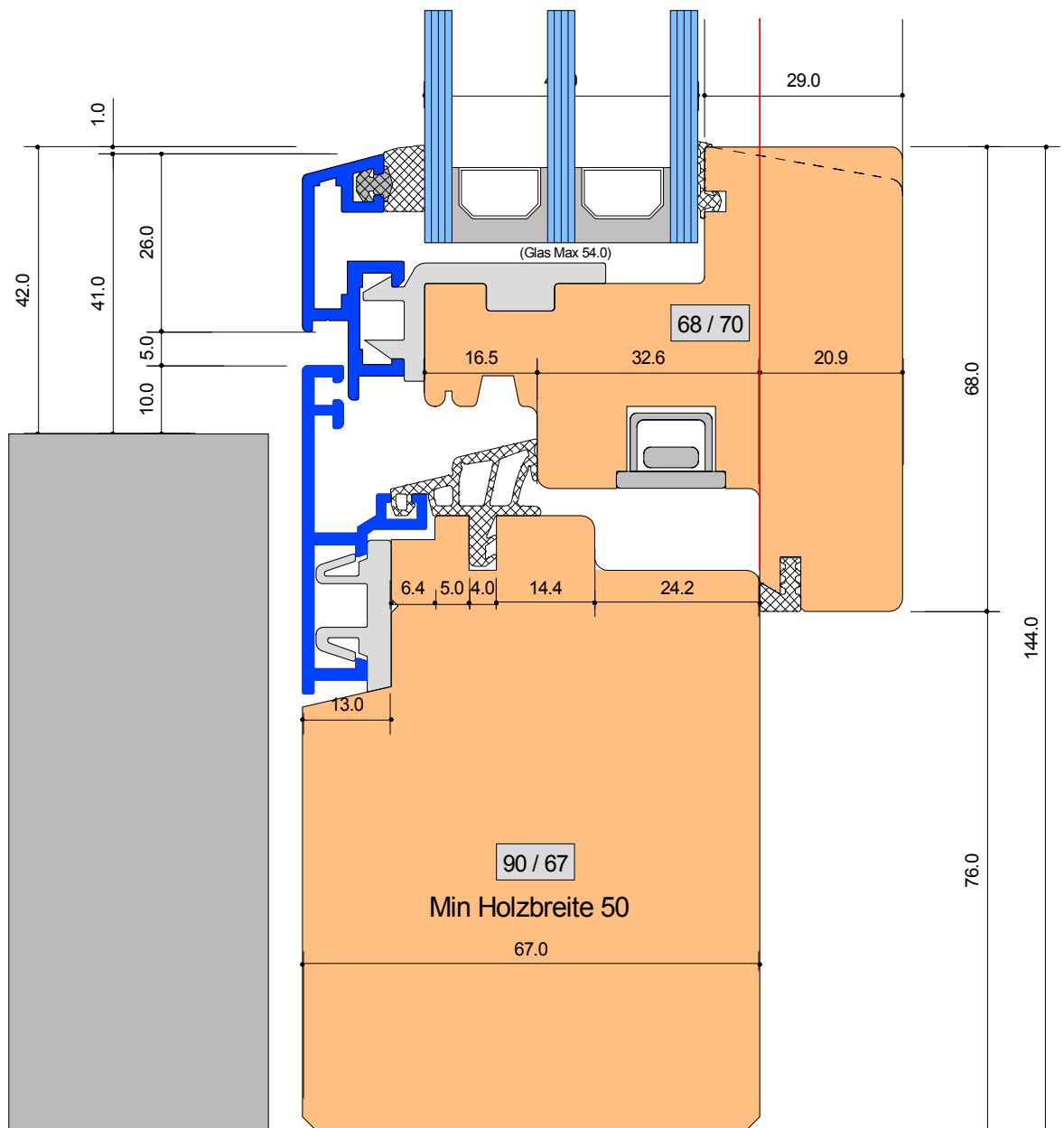

SYSTEM: M-2 67-70

Anschluss seitlich Standart Fig 68

Detail-Nr :	M-2	D=201
-------------	-----	-------



Von Euw Fenster AG
Schoosstrasse 2
6418 Rothenthurm

Tel 041 839 80 50
Fax 041 839 80 60
mail info@voneuw.ch

Ersteller: Adi von Euw
Datum: 16.06.14
Revidiert:

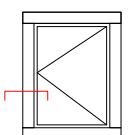

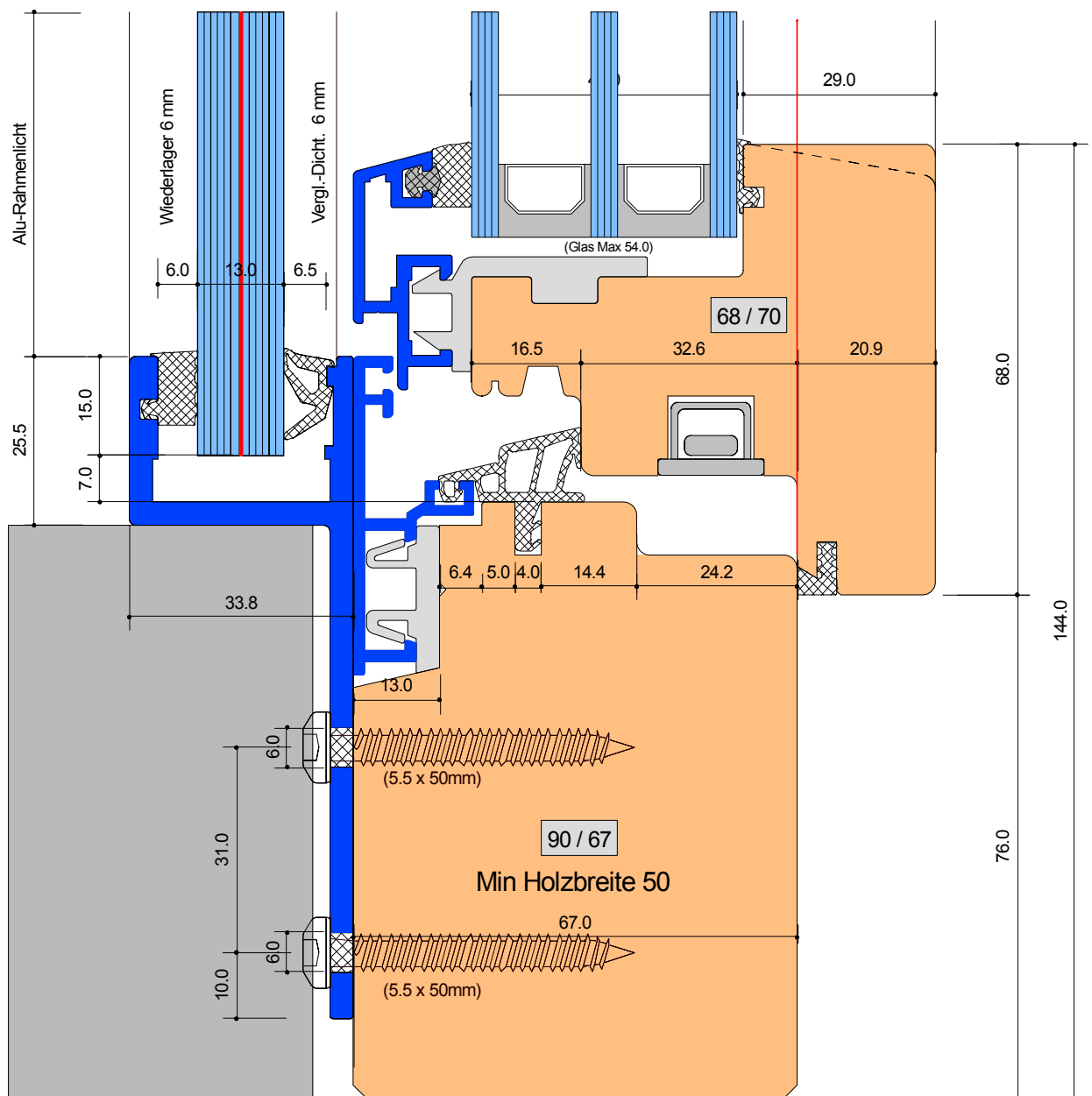

SYSTEM: M-2 67-70

Anschluss seitlich Standart Flg 68
mit Brüstungsglas VSG 12-2 ,
bis Glasbreite ca 1000 mm

Detail-Nr :	M-2	D=201G
-------------	-----	--------



Von Euw Fenster AG
Schoosstrasse 2
6418 Rothenthurm

Tel 041 839 80 50
Fax 041 839 80 60
mail info@voneuw.ch

Ersteller: Adi von Euw
Datum: 22.03.17
Revidiert:

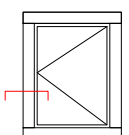

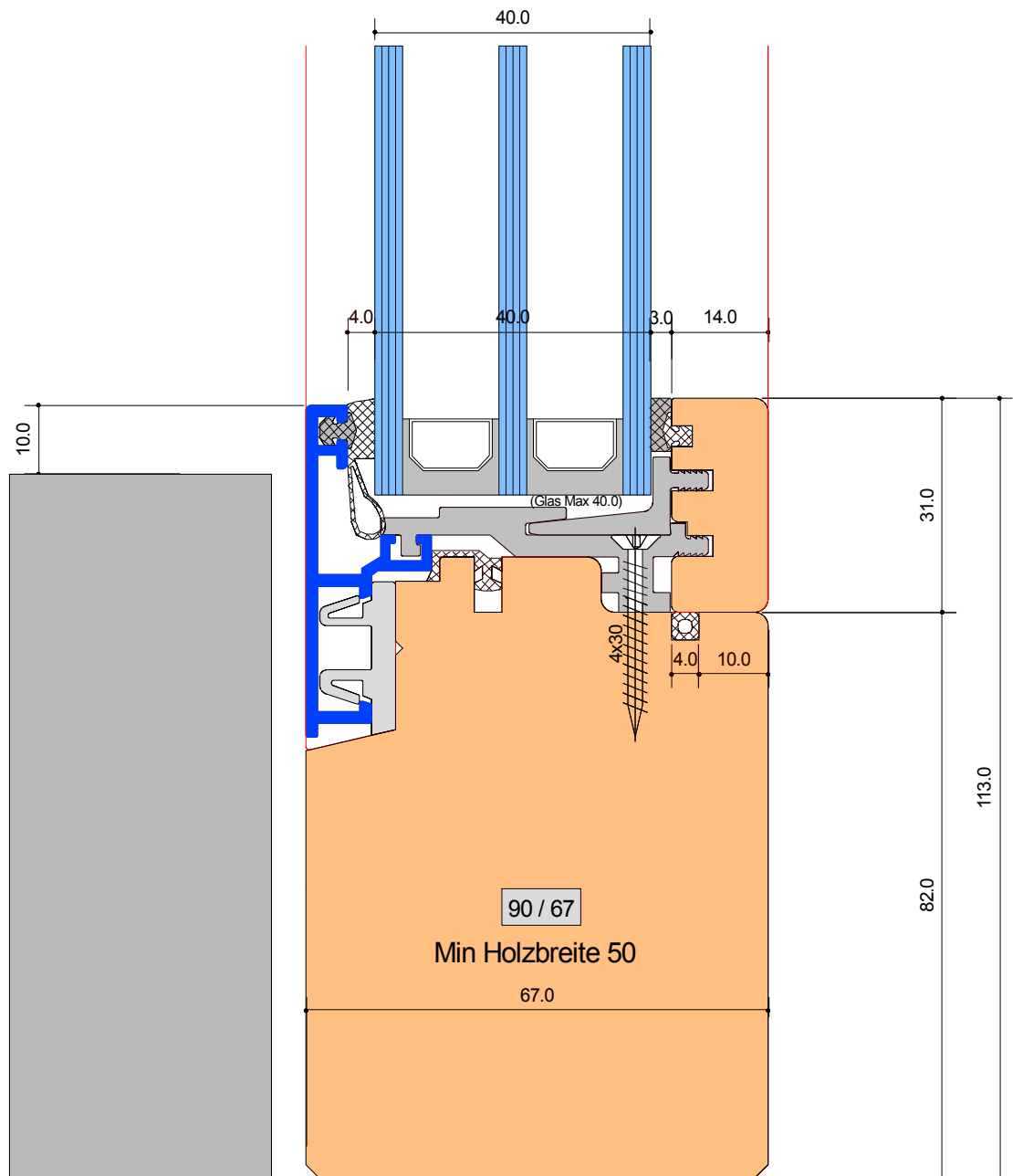

SYSTEM: M-2 67-70

Fest i.R. verglast

Detail-Nr :	M -2	D=201R
-------------	------	--------



Von Euw Fenster AG
Schoosstrasse 2
6418 Rothenthurm

Tel 041 839 80 50
Fax 041 839 80 60
mail info@voneuw.ch

Ersteller: Adi von Euw
Datum: 23.11.16
Revidiert:

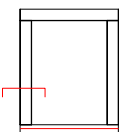

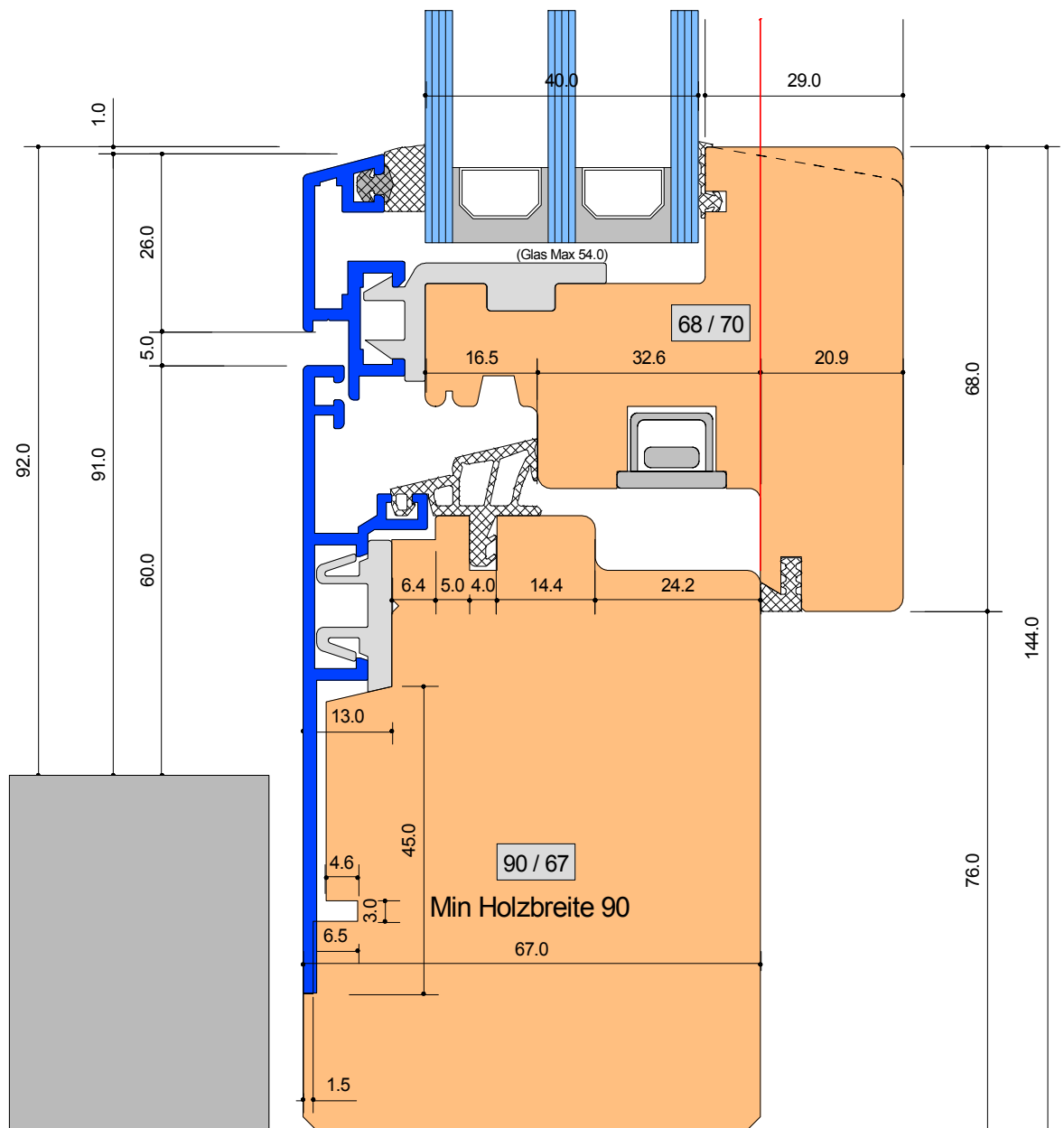

SYSTEM: M-2 67-70

Anschluss seitlich Standart Flg 68

mit breitem Profil für mehr ins Licht stehend

Detail-Nr :	M-2	D=201Z
-------------	-----	--------



Von Euw Fenster AG
Schoosstrasse 2
6418 Rothenthurm

Tel 041 839 80 50
Fax 041 839 80 60
mail info@voneuw.ch

Ersteller: Adi von Euw
Datum: 16.06.14
Revidiert:

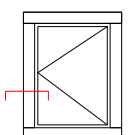

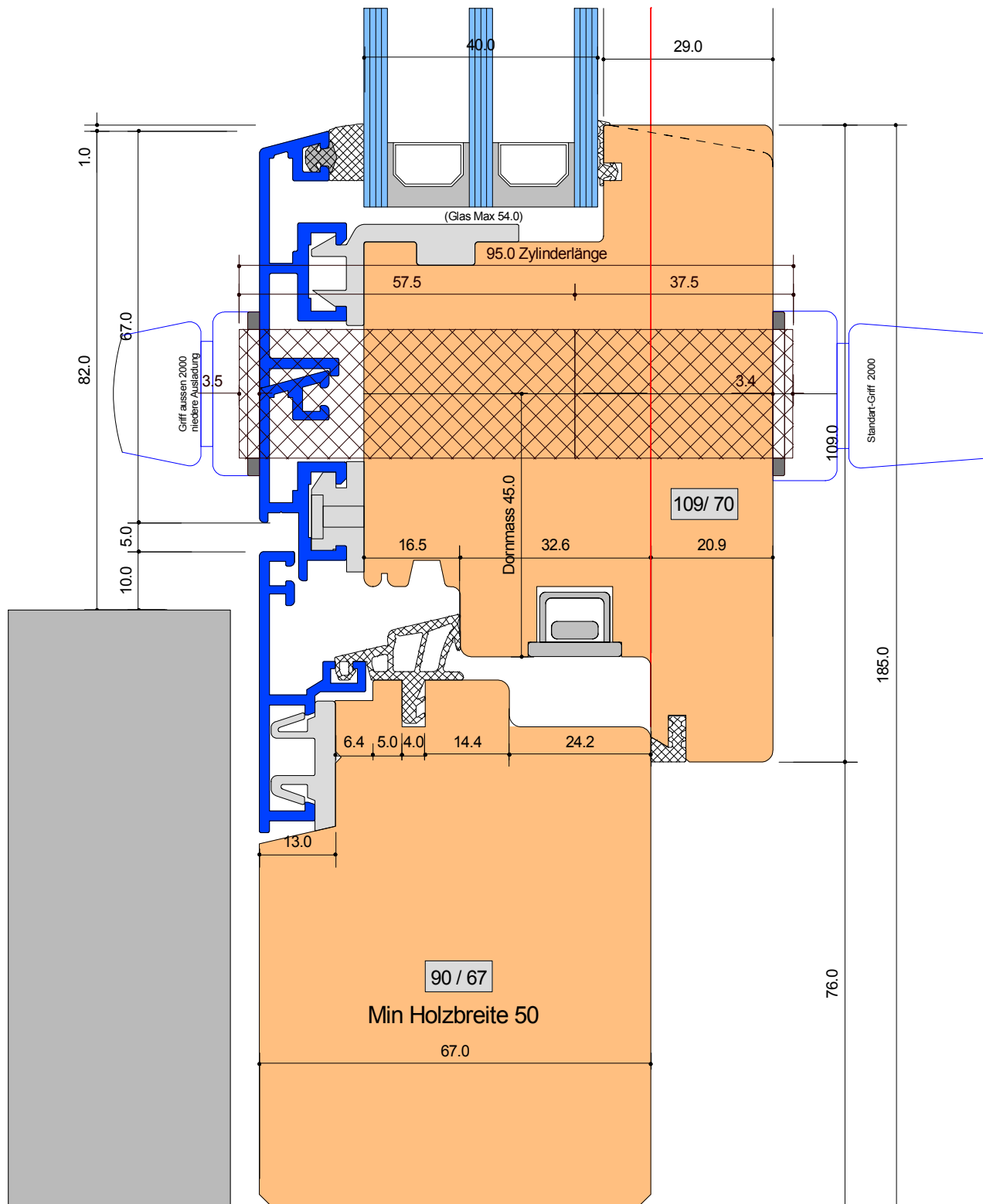

SYSTEM: M-2 67-70

Anschluss seitlich Standart Flg 109 mm
 Verschluss durchg. D=45.0 mm Griff m.Knopf/Schlüssel
 Variante: Verschluss durchg. D=45.0 mm mit Zylinder

Detail-Nr :	M -2	D=205
-------------	------	-------



Von Euw Fenster AG
 Von Euw Fenster AG
 Schoosstrasse 2
 6418 Rothenthurm

Tel 041 839 80 50
 Fax 041 839 80 60
 mail info@voneuw.ch

Ersteller: Adi von Euw
 Datum: 16.06.16
 Revidiert:

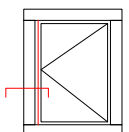

Variante 1
 Schutzschild Glutz
 ES1 5430S mit Zyl.
 Schutzrosette (10-14 mm)

Variante 2
 Rund-Schutzrosette Glutz
 ES1 5330.2S-RS mit Schutz-
 Einsatz (7-12 einwärts)

Variante 1
 Innenschild Glutz
 ES1 5435C.2 gerade

Variante 2
 Rund-Rosette innen Glutz
 5330.C mit Grundplatte

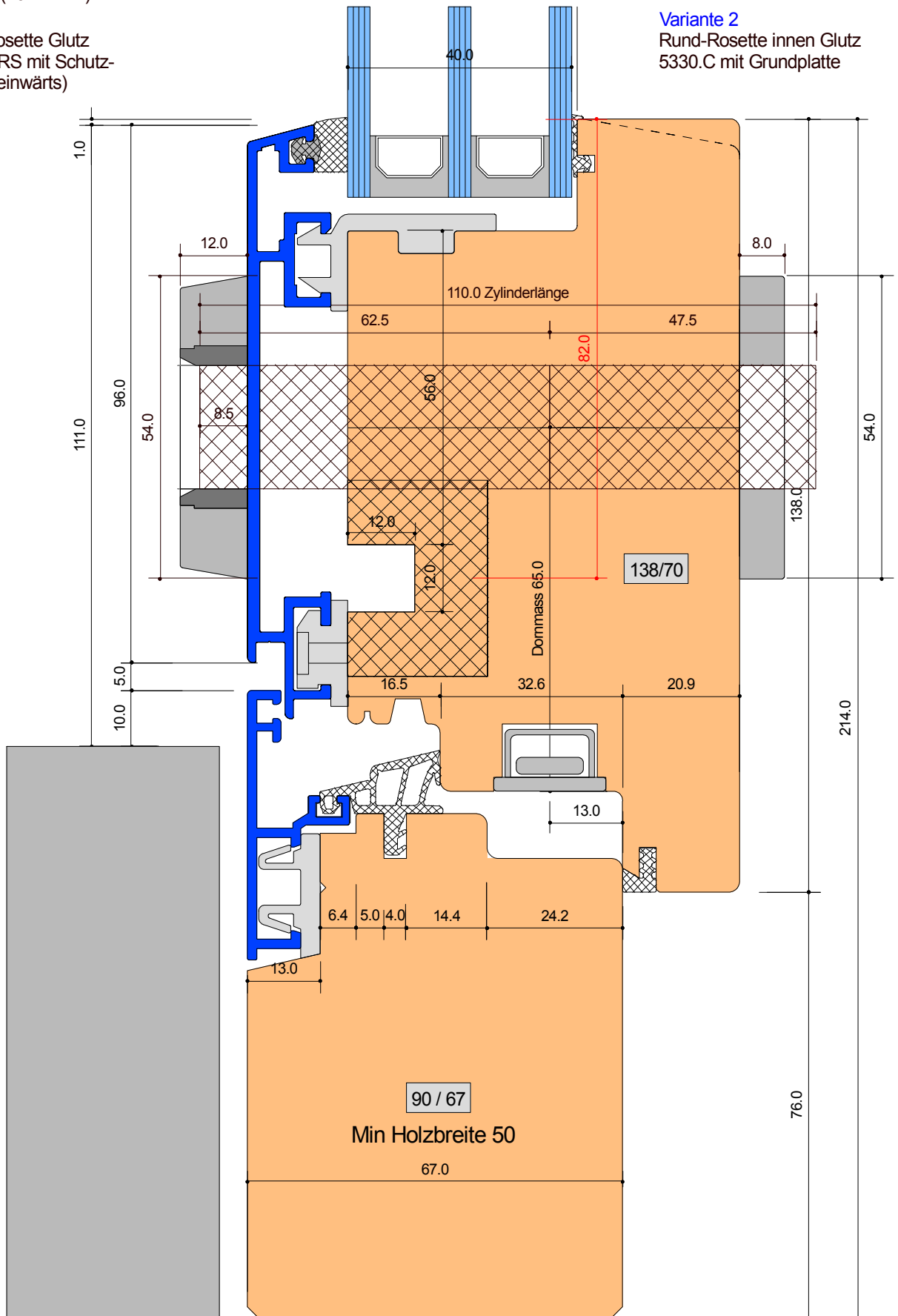

SYSTEM: M-2 67-70

Anschluss seitlich mit Flügel 138 mm
 mit Haustürverschluss D=65 mm
 mit Sicherheitslangschild Glutz 5430S/5435C.2
 mit Rund-Ros Glutz ES1 5330.2S-RS/5330C

Detail-Nr :	M-2	D=210
-------------	-----	-------



Von Euw Fenster AG
 Schoosstrasse 2
 6418 Rothenthurm

Tel 041 839 80 50
 Fax 041 839 80 60
 mail info@voneuw.ch

Ersteller: Adi von Euw
 Datum: 15.06.16
 Revidiert:

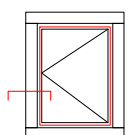

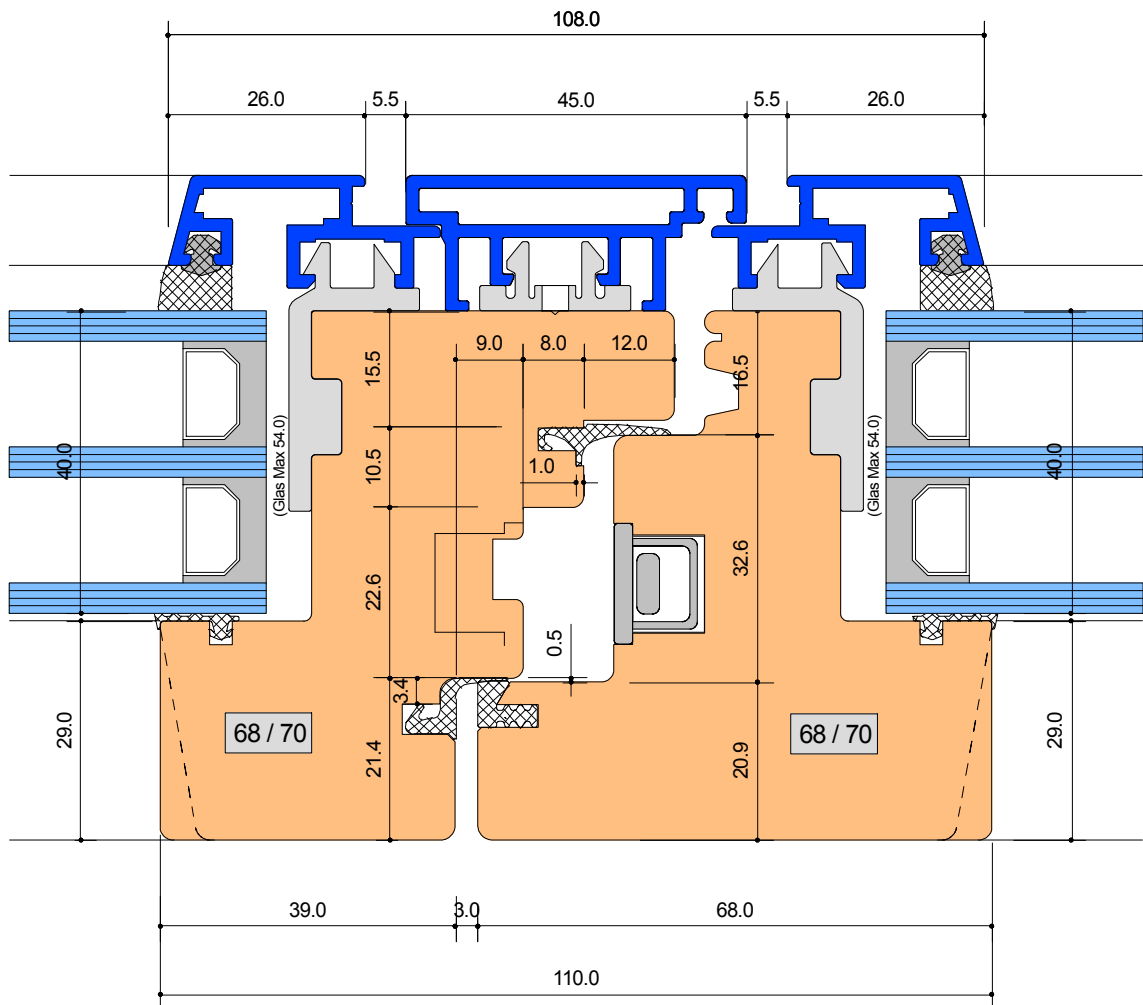

SYSTEM: M-2 67-70

Mittelpartie Standart 2 x Flg 68

Detail-Nr :	M -2	D=301
-------------	------	-------



Von Euw Fenster AG
Schoosstrasse 2
6418 Rothenthurm

Tel 041 839 80 50
Fax 041 839 80 60
mail info@voneuw.ch

Ersteller: Adi von Euw
Datum: 16.06.14
Revidiert: 24.10.19

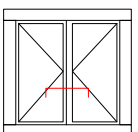

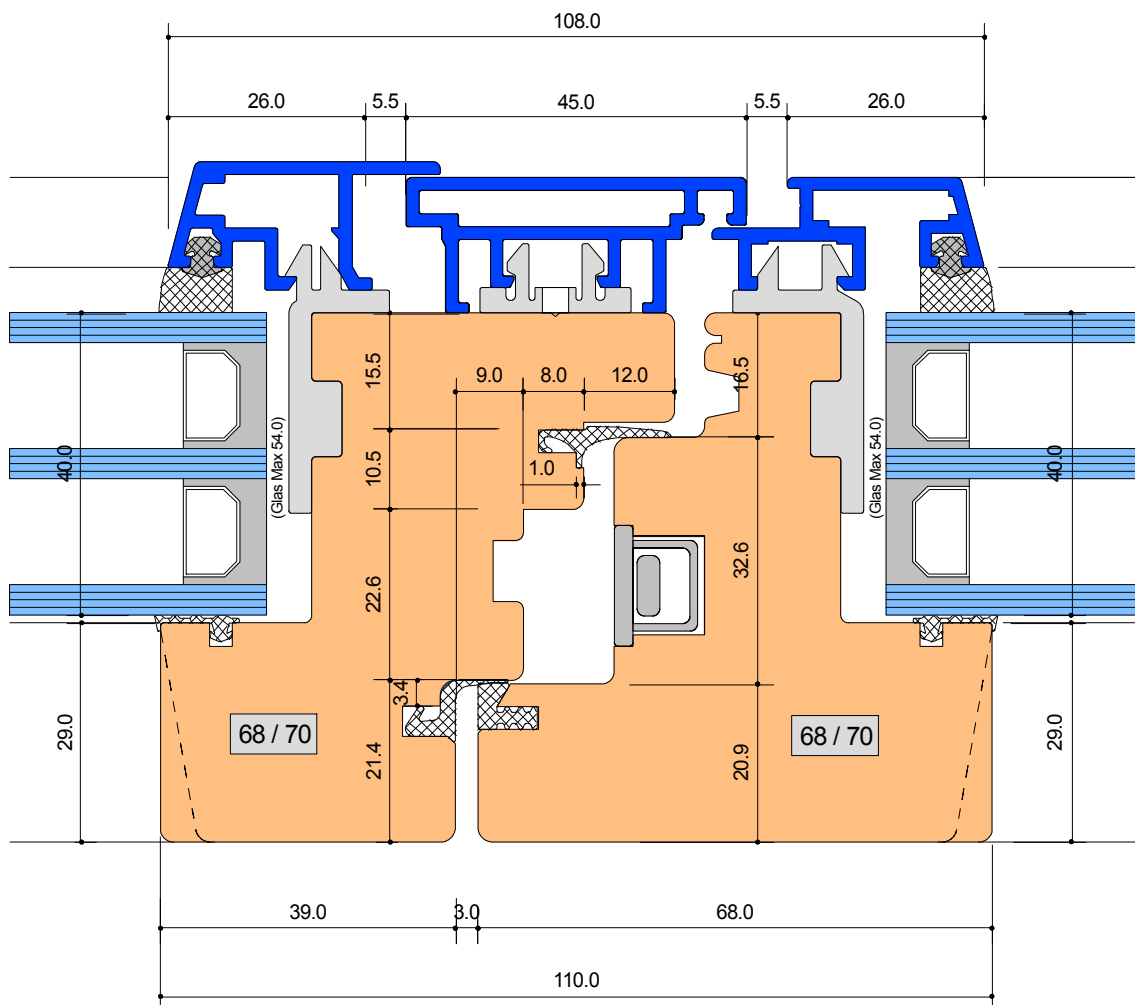

SYSTEM: M-2 67-70

Mittelpartie einseitig mit fest vergl. Fig v. aussen

Detail-Nr :	M -2	D=310
-------------	------	-------



Von Euw Fenster AG
Schoosstrasse 2
6418 Rothenthurm

Tel 041 839 80 50
Fax 041 839 80 60

mail info@voneuw.ch

Ersteller: Adi von Euw
Datum: 16.06.14
Revidiert: 24.10.19

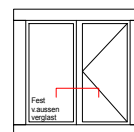

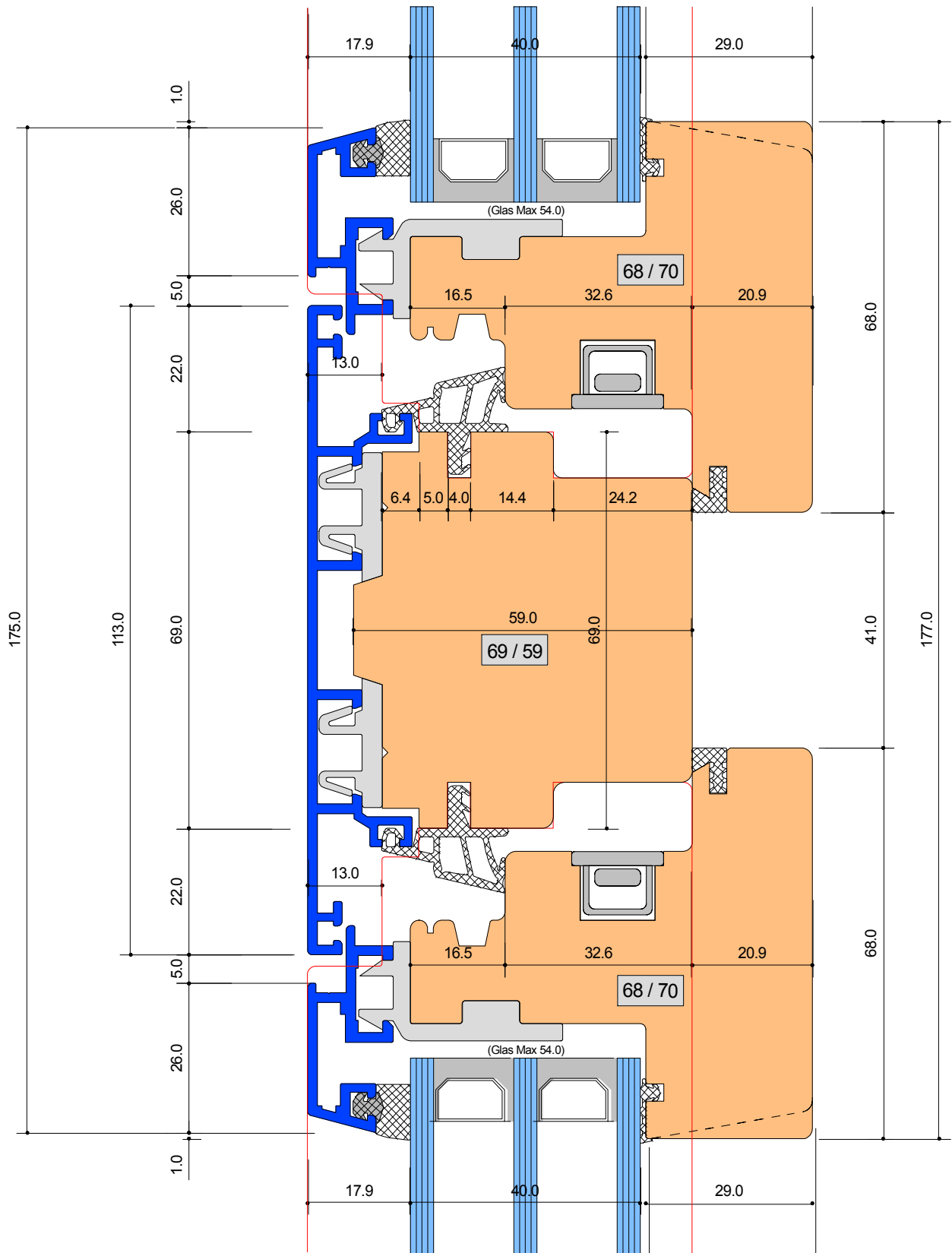

SYSTEM: M-2 67-70

Kämpfer und Setzholz Alu 113 mm

Detail-Nr : M-2 D=401

Ersteller: Adi von Euw
 Datum: 16.06.14
 Revidiert:



Von Euw Fenster AG
 Schoosstrasse 2
 6418 Rothenthurm

Tel 041 839 80 50
 Fax 041 839 80 60
 mail info@voneuw.ch

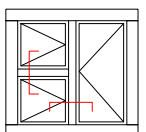

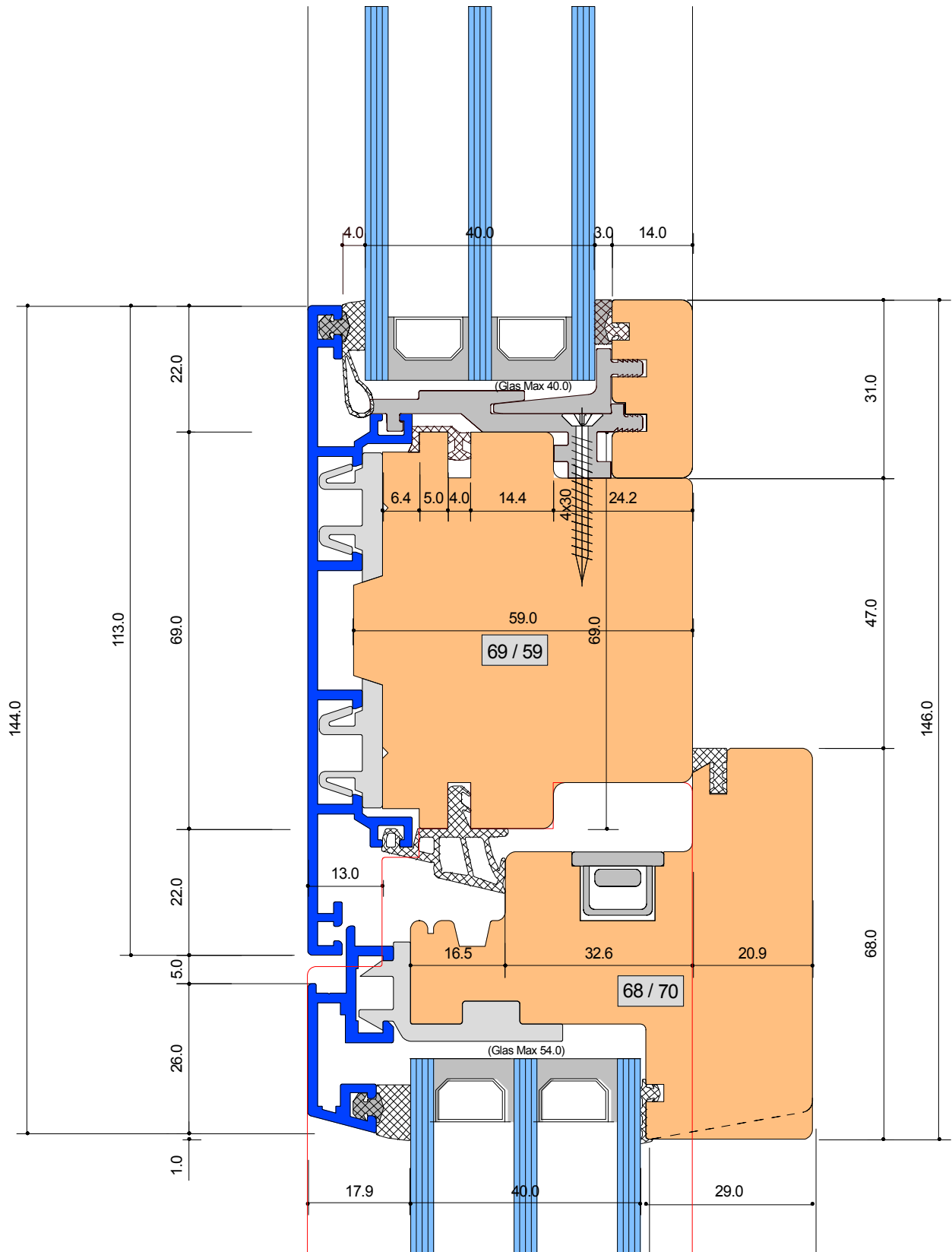

SYSTEM: M-2 67-70

Kämpfer und Setzholz Alu 113 mm
einseitig fest i.R. verglast

Detail-Nr :	M -2	D=401R
-------------	------	--------

Ersteller: Adi von Euw
Datum: 23.11.16
Revidiert:



Von Euw Fenster AG
Schoosstrasse 2
6418 Rothenthurm

Tel 041 839 80 50
Fax 041 839 80 60
mail info@voneuw.ch

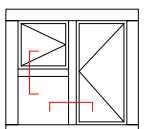

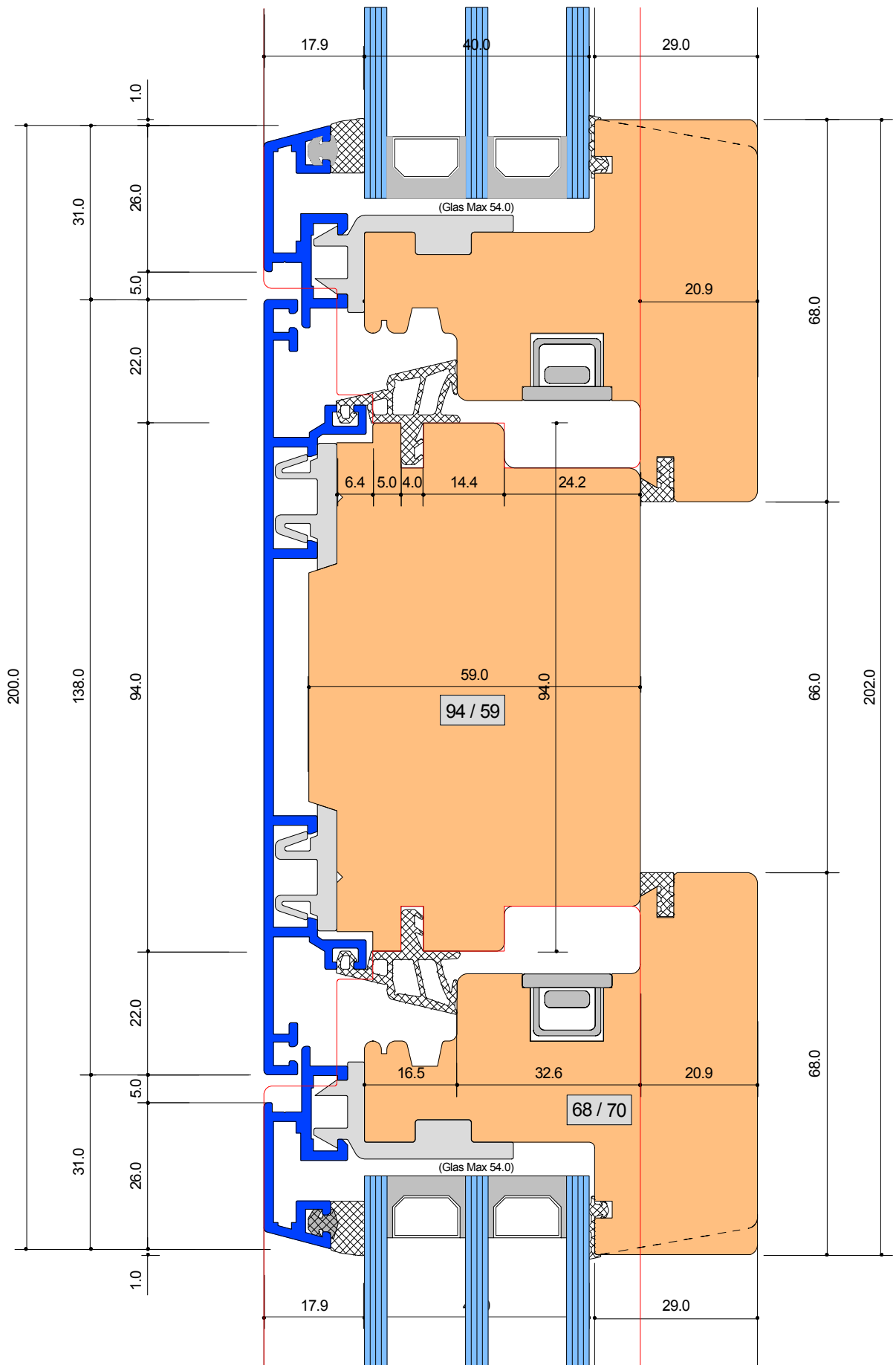

SYSTEM: M-2 67-70

Kämpfer und Setzholz Alu 138 mm

Detail-Nr :	M -2	D=402
-------------	------	-------

Ersteller: Adi von Euw
 Datum: 16.06.14
 Revidiert:



Von Euw Fenster AG
 Schoosstrasse 2
 6418 Rothenthurm

Tel 041 839 80 50
 Fax 041 839 80 60
 mail info@voneuw.ch

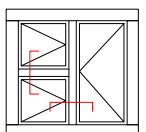

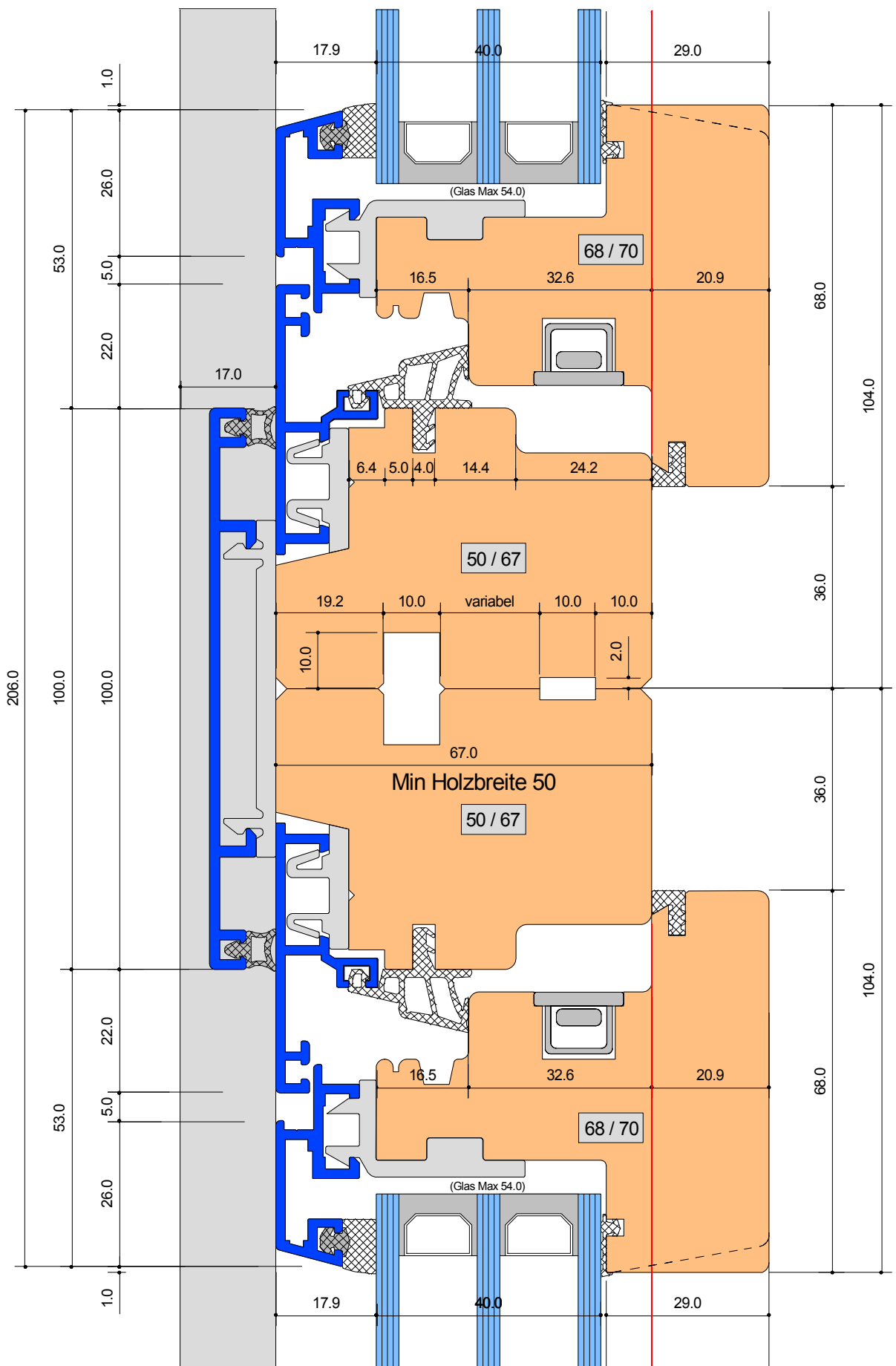

SYSTEM: M-2 67-70

Kombinationszusammenbau mit Nut + Feder

Detail-Nr : M-2 D=405

Ersteller: Adi von Euw
Datum: 16.06.14
Revidiert:



Von Euw Fenster AG
Schoosstrasse 2
6418 Rothenthurm

Tel 041 839 80 50
Fax 041 839 80 60
mail info@voneuw.ch

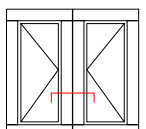

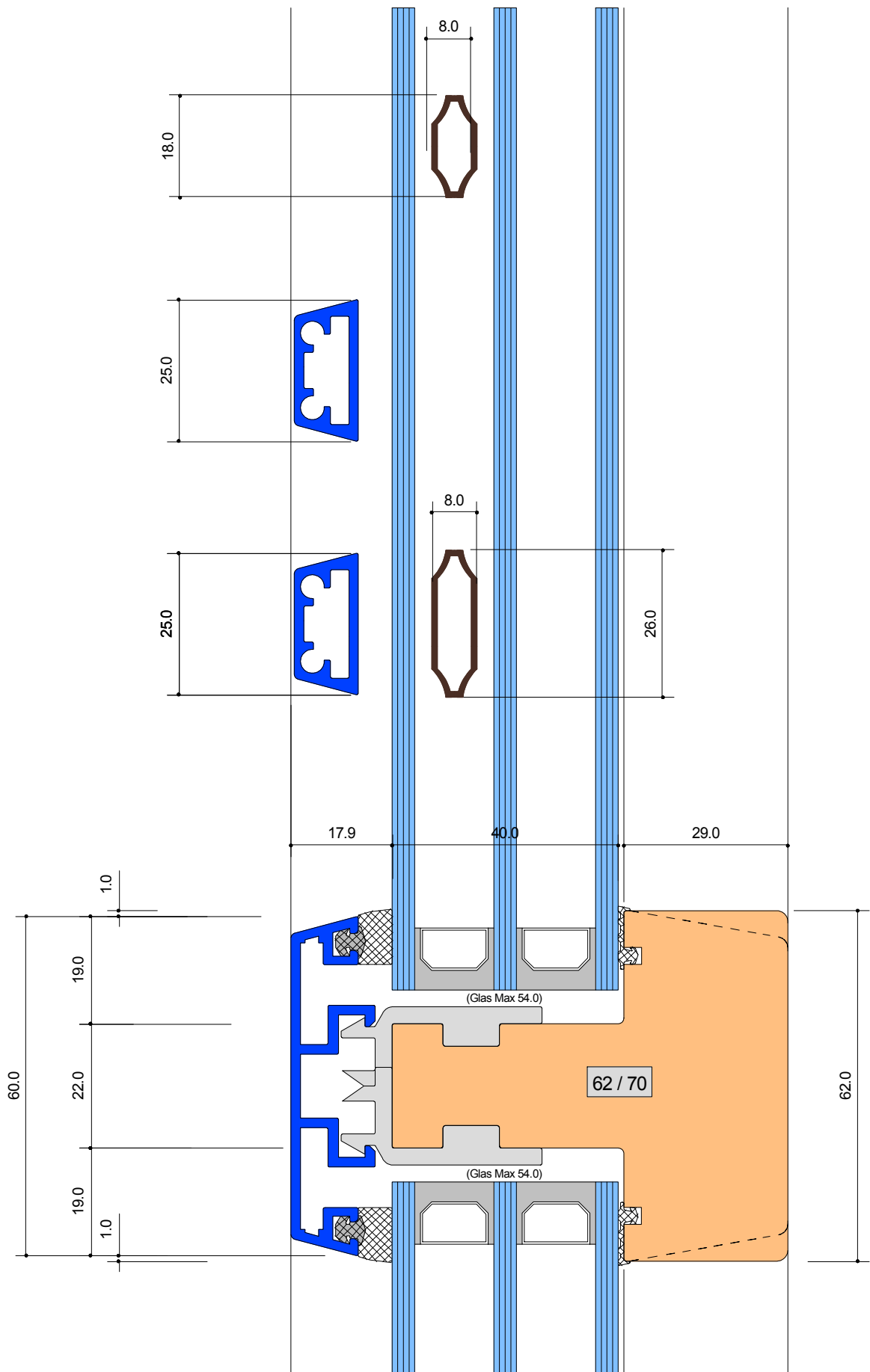

SYSTEM: M-2 67-70

Sprossen glastrennend 62 mm Alu 60 mm
 Vorgesetzte Alu-Spr. 25 mm +Zw.Glas Sprosse 26 mm
 Vorgesetzte Alu-Spr. 25 mm
 Zwischenglas -Sprosse 18 mm

Detail-Nr :	M -2	D=601
-------------	------	-------



Von Euw Fenster AG
 Schoosstrasse 2
 6418 Rothenthurm

Tel 041 839 80 50
 Fax 041 839 80 60
 mail info@voneuw.ch

Ersteller: Adi von Euw
 Datum: 16.06.14
 Revidiert:

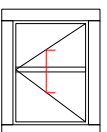

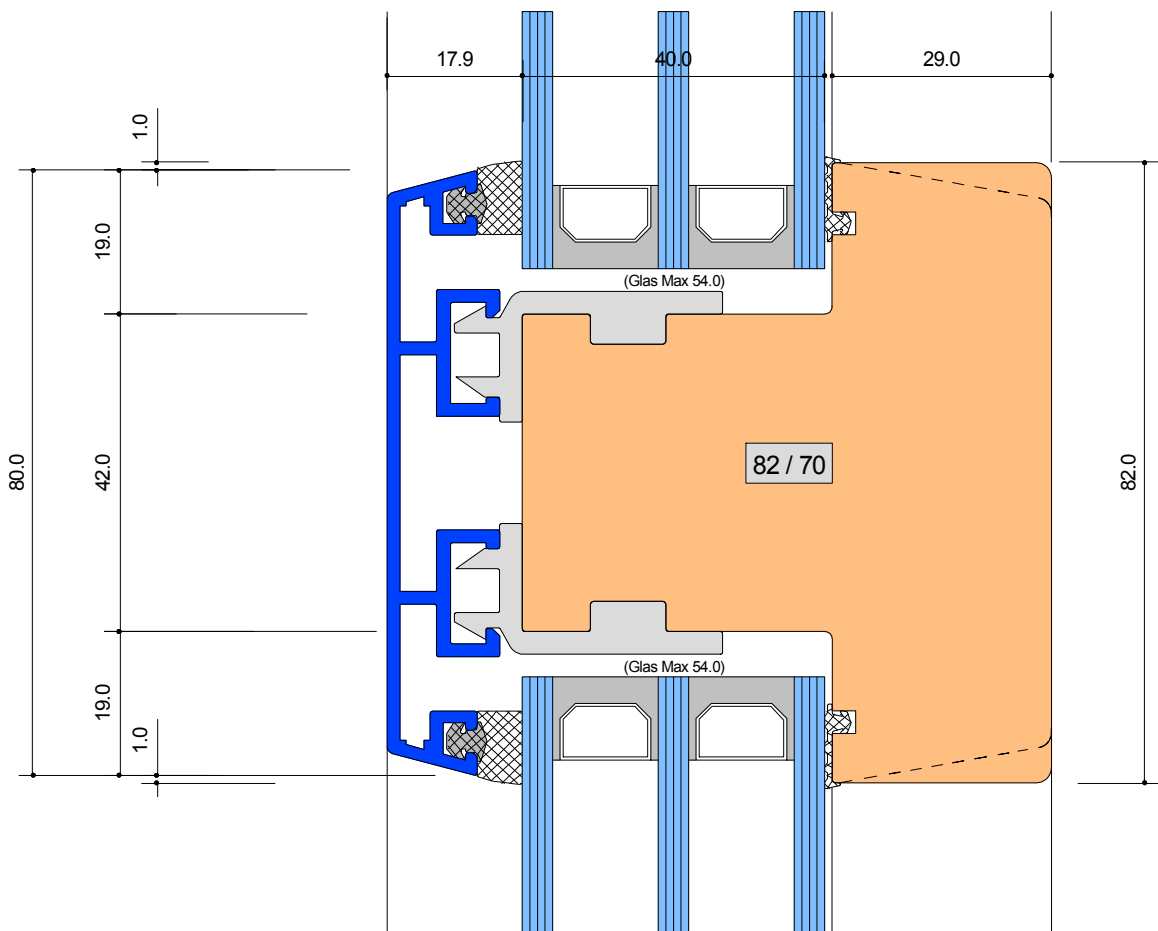

SYSTEM: M-2 67-70

Sprossen glastrennend 80 mm

Detail-Nr :	M -2	D=602
-------------	------	-------



Von Euw Fenster AG
Schoosstrasse 2
6418 Rothenthurm

Tel 041 839 80 50
Fax 041 839 80 60
mail info@voneuw.ch

Ersteller: Adi von Euw
Datum: 16.06.14
Revidiert:

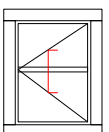

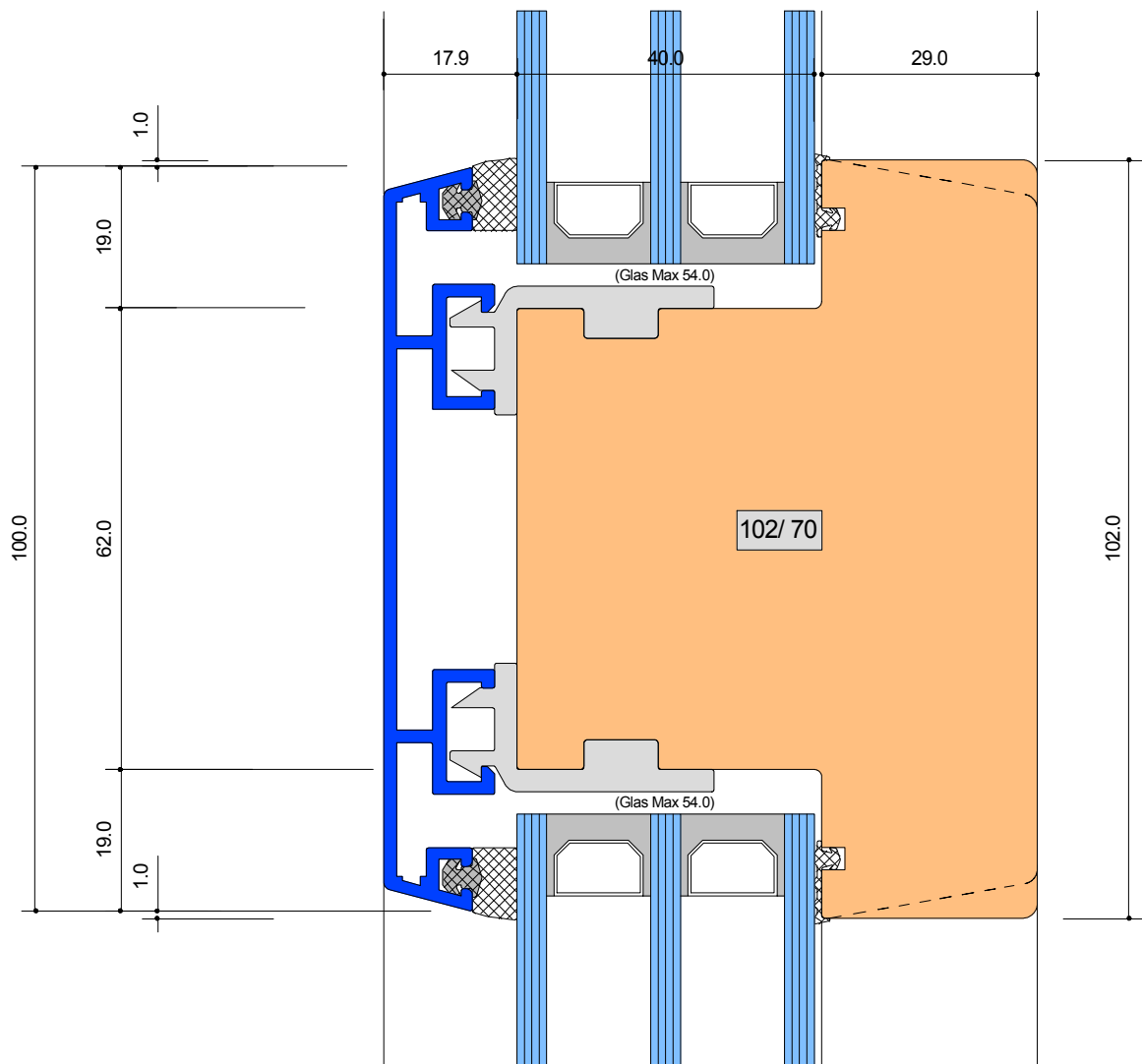

SYSTEM: M-2 67-70

Sprossen glastrennend 100 mm

Detail-Nr :	M -2	D=603
-------------	------	-------



Von Euw Fenster AG
 Schoosstrasse 2
 6418 Rothenthurm

Tel 041 839 80 50
 Fax 041 839 80 60

mail info@voneuw.ch

Ersteller: Adi von Euw
 Datum: 16.06.14
 Revidiert:

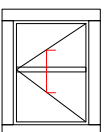

N69202 0.353 g/m1
 X1-ST 045-008 (roh+eloxiert)
 Fräsung 30.0 x 5.0 mm
 Abstand 125/25x250/125

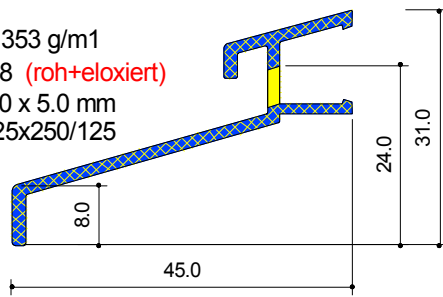

N74777 0.378 g/m1
 X1-ST 045-013 (roh+eloxiert)
 Fräsung 30.0 x 5.0 mm
 Abstand 125/25x250/125

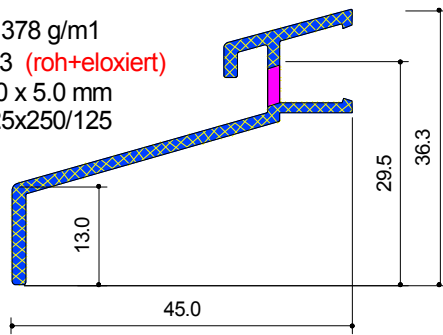

N70586 0.445 g/m1
 X1-ST 065-008 (roh+eloxiert)
 Fräsung 30.0 x 5.0 mm
 Abstand 125/25x250/125

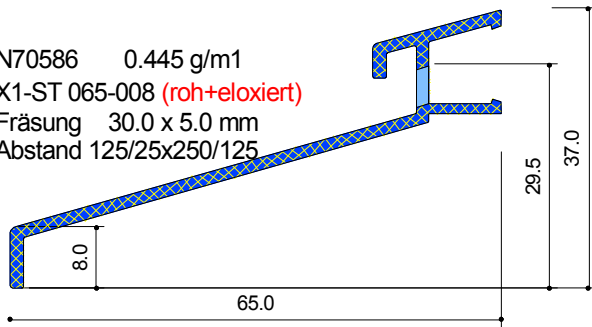

N74260 0.561 g/m1
 X1-ST 065-030 (eloxiert)
 Fräsung 30.0 x 5.0 mm
 Abstand 125/25x250/125

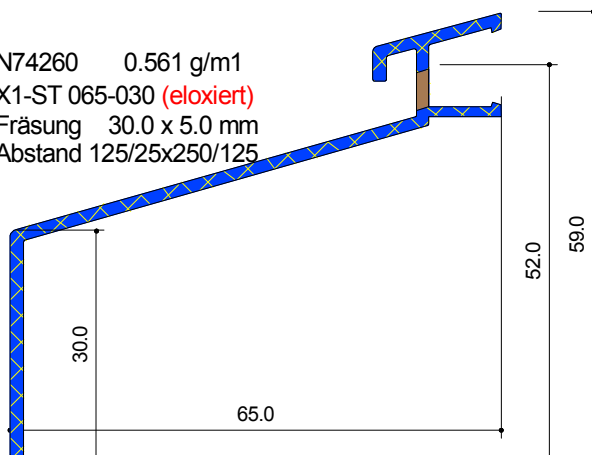

N70584 0.295 g/m1
 X1-ST 017-021 (eloxiert)
 Fräsung 30.0 x 5.0 mm
 Abstand 125/25x250/125

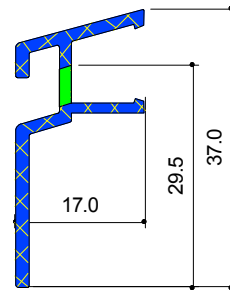

N70585 0.393 g/m1
 X1-ST 017-041 (eloxiert)
 Fräsung 30.0 x 5.0 mm
 Abstand 125/25x250/125

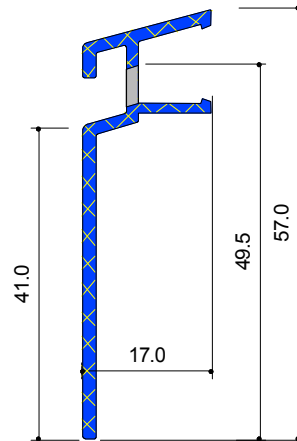

N74261 0.620 g/m1
 X1-ST 017-084 (eloxiert)
 Fräsung 30.0 x 5.0 mm
 Abstand 125/25x250/125

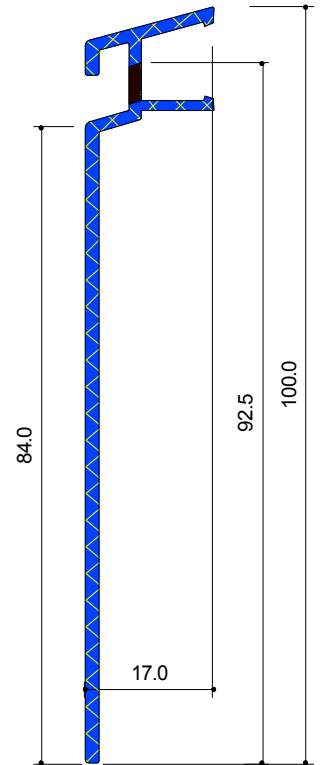

L49108 0.450 g/m1
 M1-GR 038-18 Roll (roh)
 Fräsung 30.0 x 5.0 mm
 Abstand 50/32x200/50

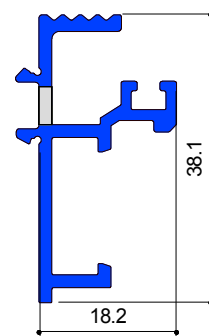

SYSTEM: *H, L, M, R*

Steckteil-Profilübersicht

Detail-Nr : A-1 D=100



Von Euw Fenster AG
 Schoosstrasse 2
 6418 Rothenthurm

Tel 041 839 80 50
 Fax 041 839 80 60
 mail info@voneuw.ch

Ersteller: Adi von Euw
 Datum: 28.03.17

- Alu *roh* (Lager)
- Alu *farblos elox.* (Lager)
- Alu *Roh + farblos elox.* (Lager)