

Holz-Metallfenster

System : L-3 71/74 „light class“

Vermasste Standard-Details

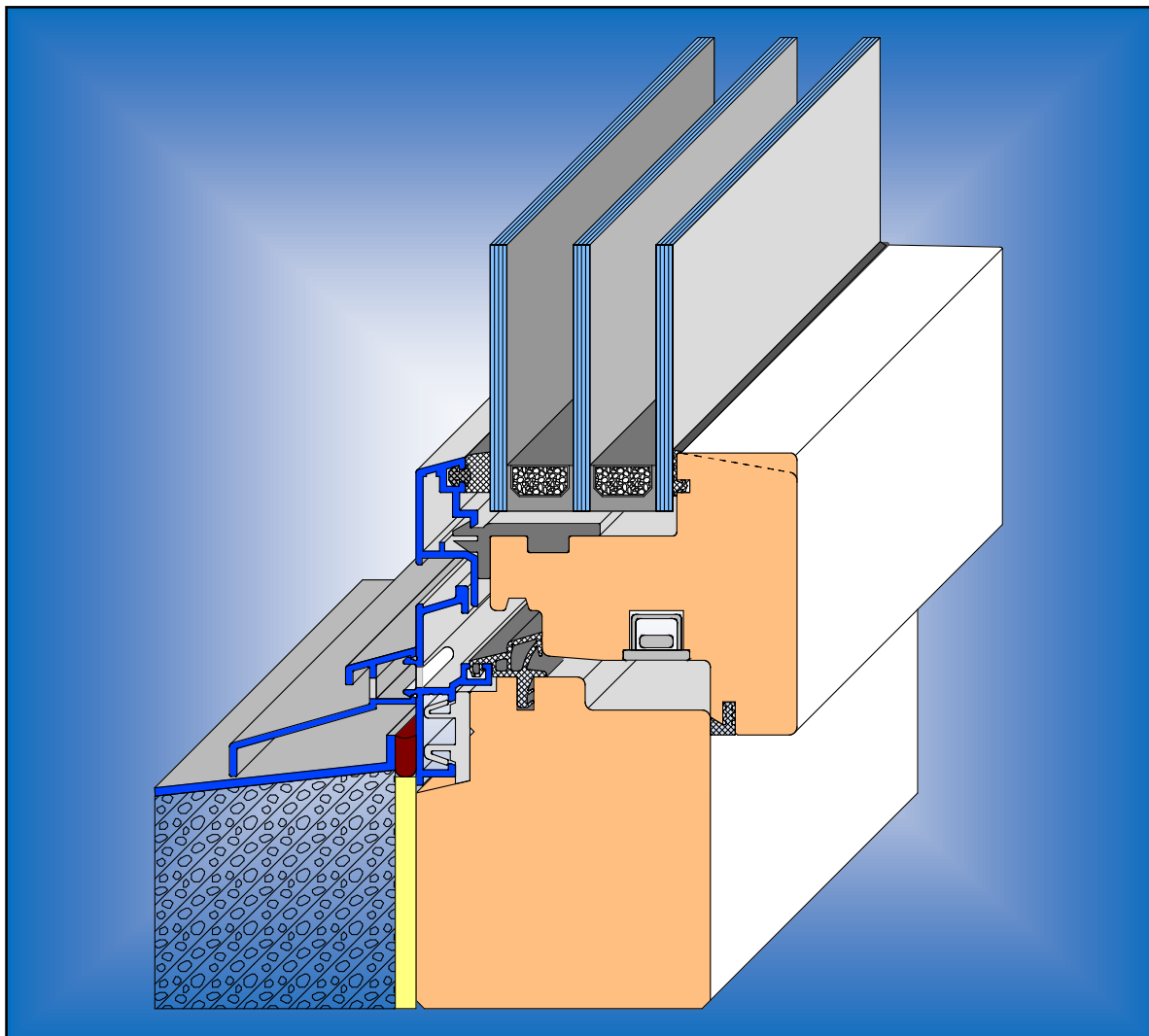

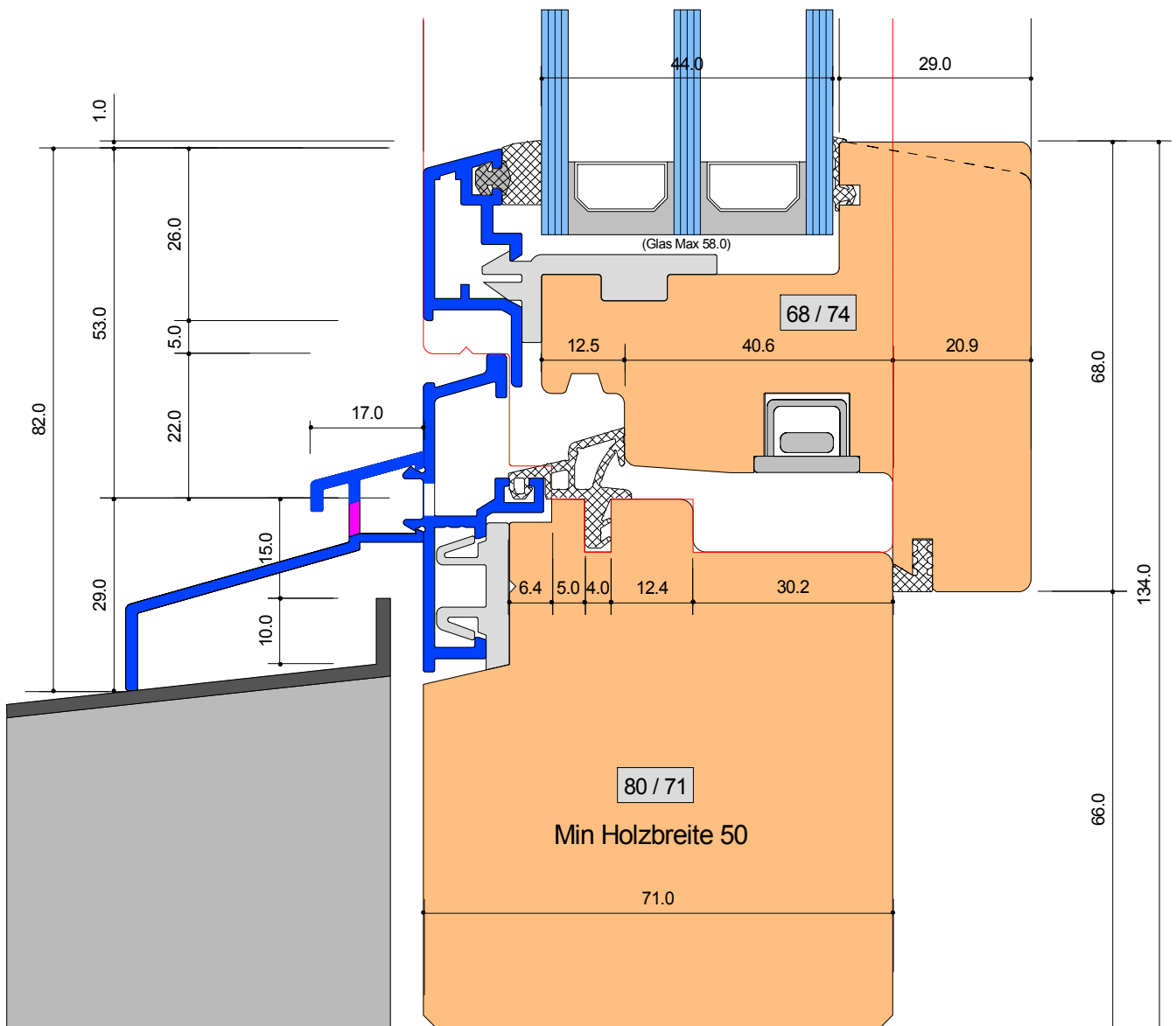

SYSTEM: L-3 71-74

Anschluss unten mit Alu Fensterbank
Wetterschenkel Typ RWS 045-013

Detail-Nr :	L -3	D=001
-------------	------	-------



Von Euw Fenster AG
Schoosstrasse 2
6418 Rothenthurm

Tel 041 839 80 50
Fax 041 839 80 60
mail info@voneuw.ch

Ersteller: Adi von Euw
Datum: 16.06.14
Revidiert:

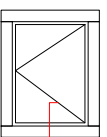

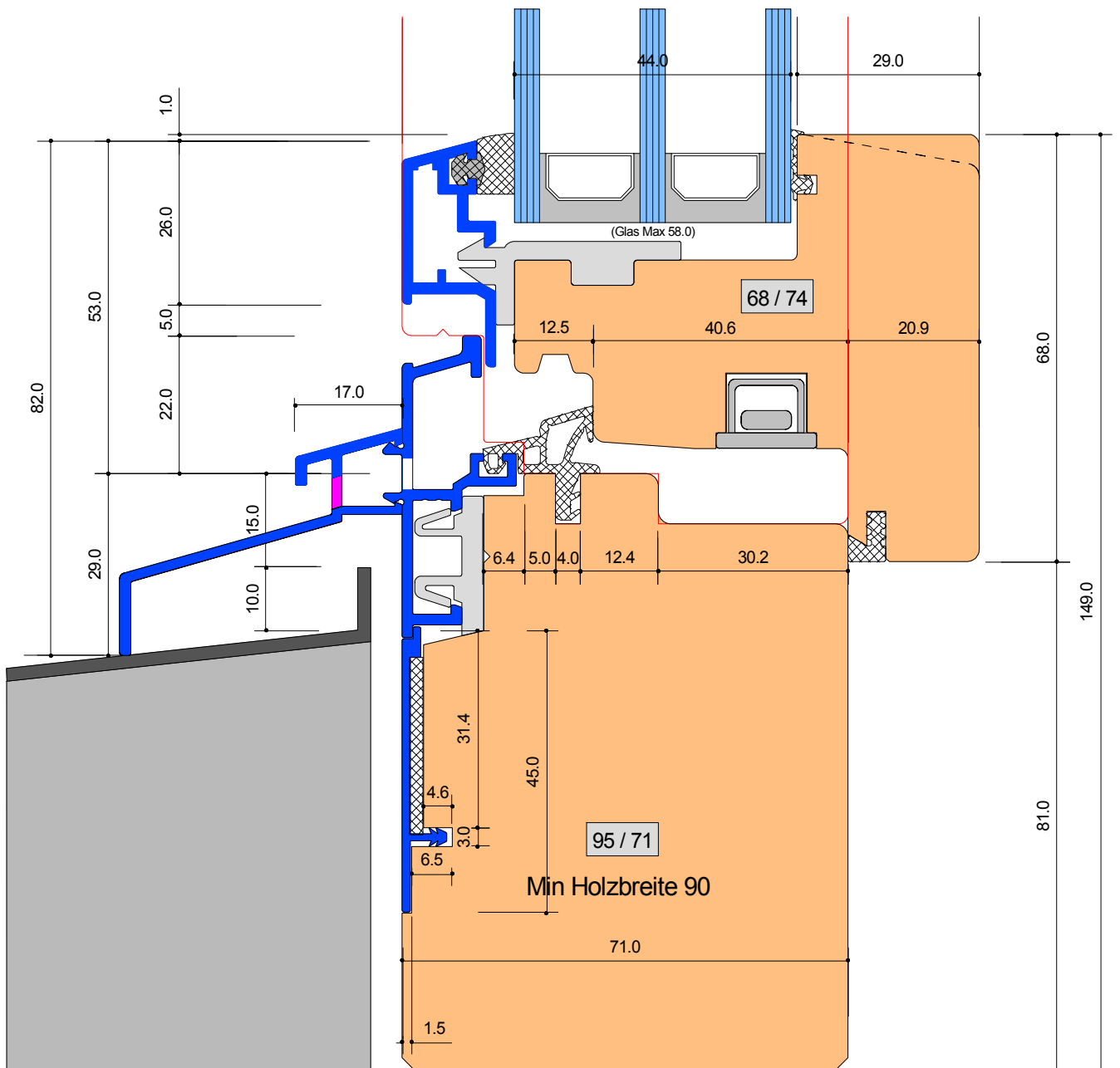

SYSTEM: L-3 71-74

Anschluss unten mit Alu Fensterbank
 Wetterschenkel Typ RWS 045-013
 mit Zusatzprofil für Abklebung bauseits

Detail-Nr :	L -3	D=001Z
-------------	------	--------



Von Euw Fenster AG
 Schoosstrasse 2
 6418 Rothenthurm

Tel 041 839 80 50
 Fax 041 839 80 60
 mail info@voneuw.ch

Ersteller: Adi von Euw
 Datum: 16.06.14
 Revidiert:

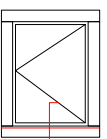

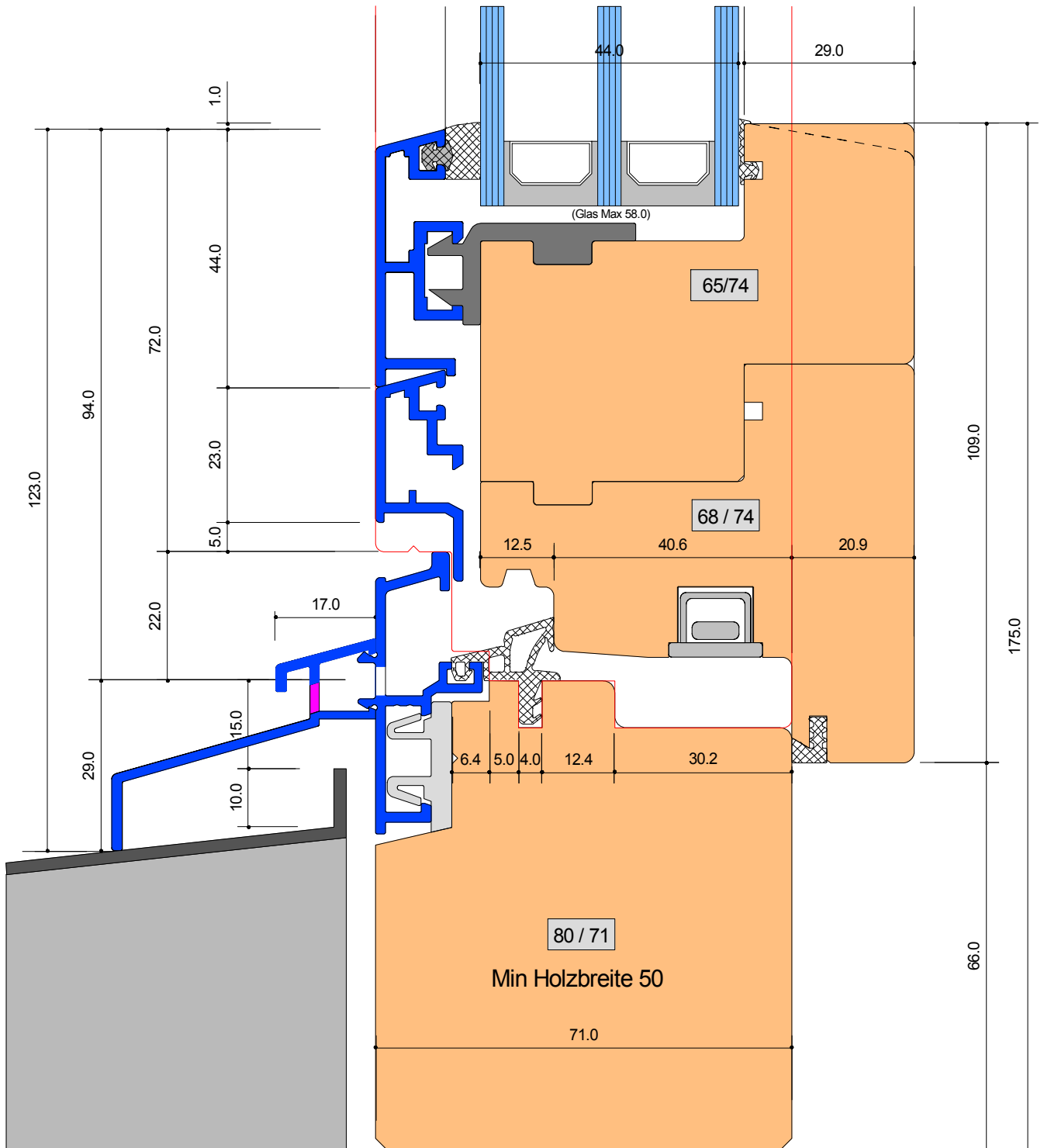

SYSTEM: L-3 71-74

Anschluss unten BT 109 mm breit
Wetterschenkel Typ RWS 045-013

Detail-Nr :	L -3	D=005
-------------	------	-------



Von Euw Fenster AG
Schoosstrasse 2
6418 Rothenthurm

Tel 041 839 80 50
Fax 041 839 80 60
mail info@voneuw.ch

Ersteller: Adi von Euw
Datum: 16.06.14
Revidiert:

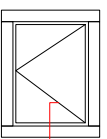

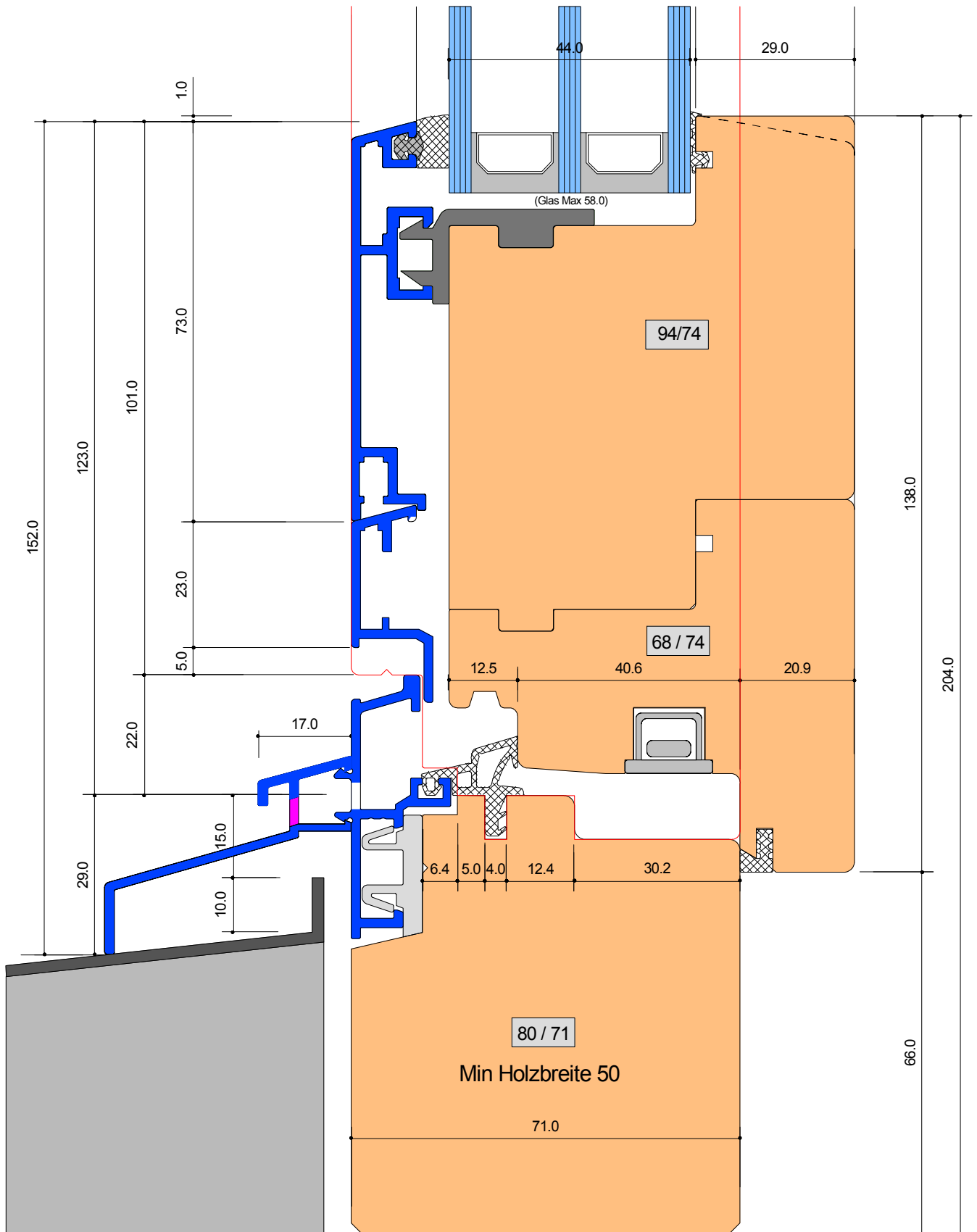

SYSTEM: L-3 71-74

Anschluss unten BT 138 mm breit
Wetterschenkel Typ RWS 045-013

Detail-Nr :	L -3	D=006
-------------	------	-------



Von Euw Fenster AG
Schoosstrasse 2
6418 Rothenthurm

Tel 041 839 80 50
Fax 041 839 80 60
mail info@voneuw.ch

Ersteller: Adi von Euw
Datum: 16.06.14
Revidiert:

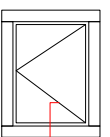

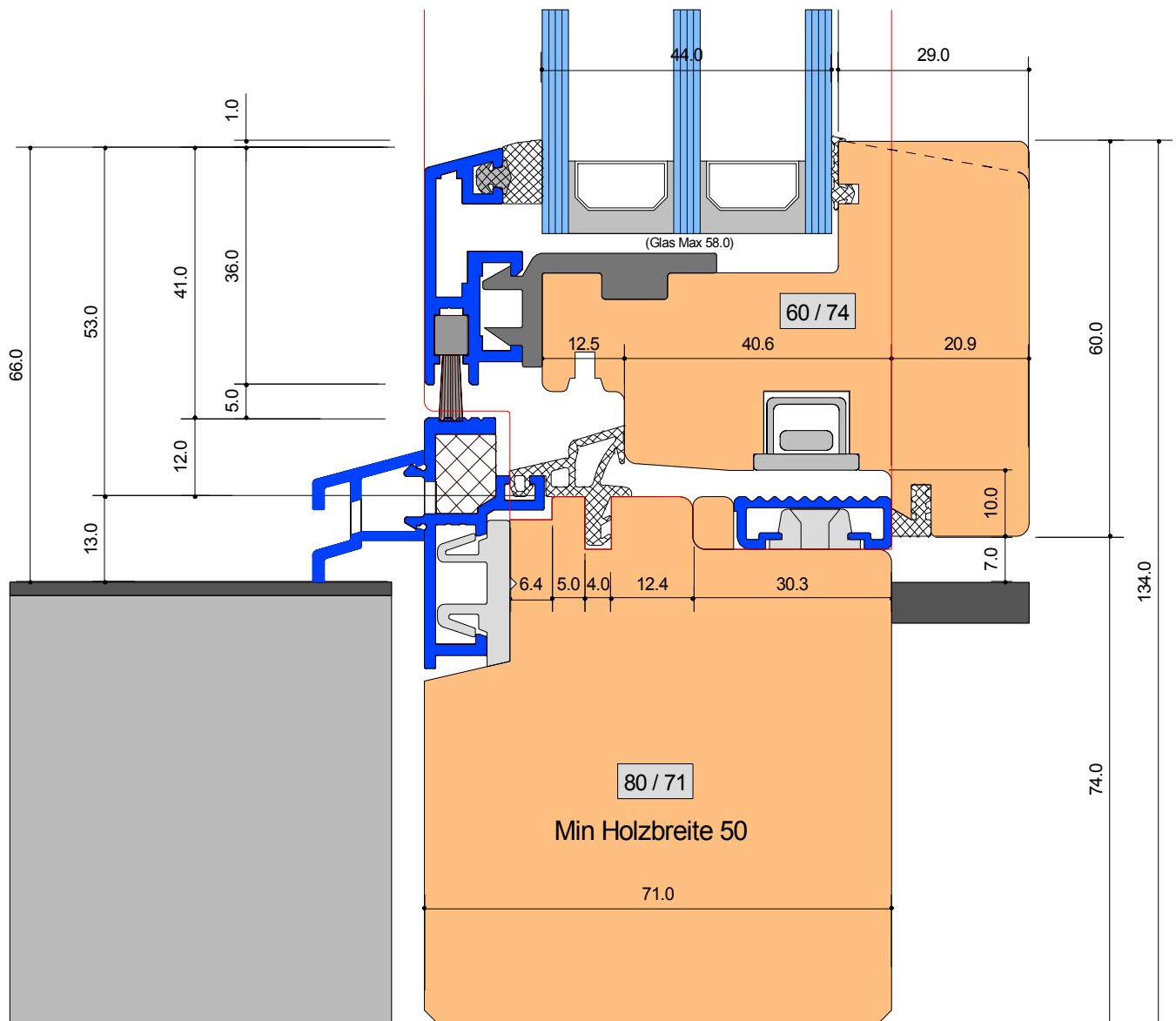

SYSTEM: L-3 71-74

Anschluss unten Rollstuhlgängig
 Mit Flügelbreite 60 mm (-8.0mm)
 Grundprofil M1-GR 038-18 Roll / Steckteil Variabel

Detail-Nr :	L -3	D=021
-------------	------	-------



Von Euw Fenster AG
 Schoosstrasse 2
 6418 Rothenthurm

Tel 041 839 80 50
 Fax 041 839 80 60
 mail info@voneuw.ch

Ersteller: Adi von Euw
 Datum: 16.06.14
 Revidiert: 05.11.19

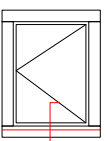

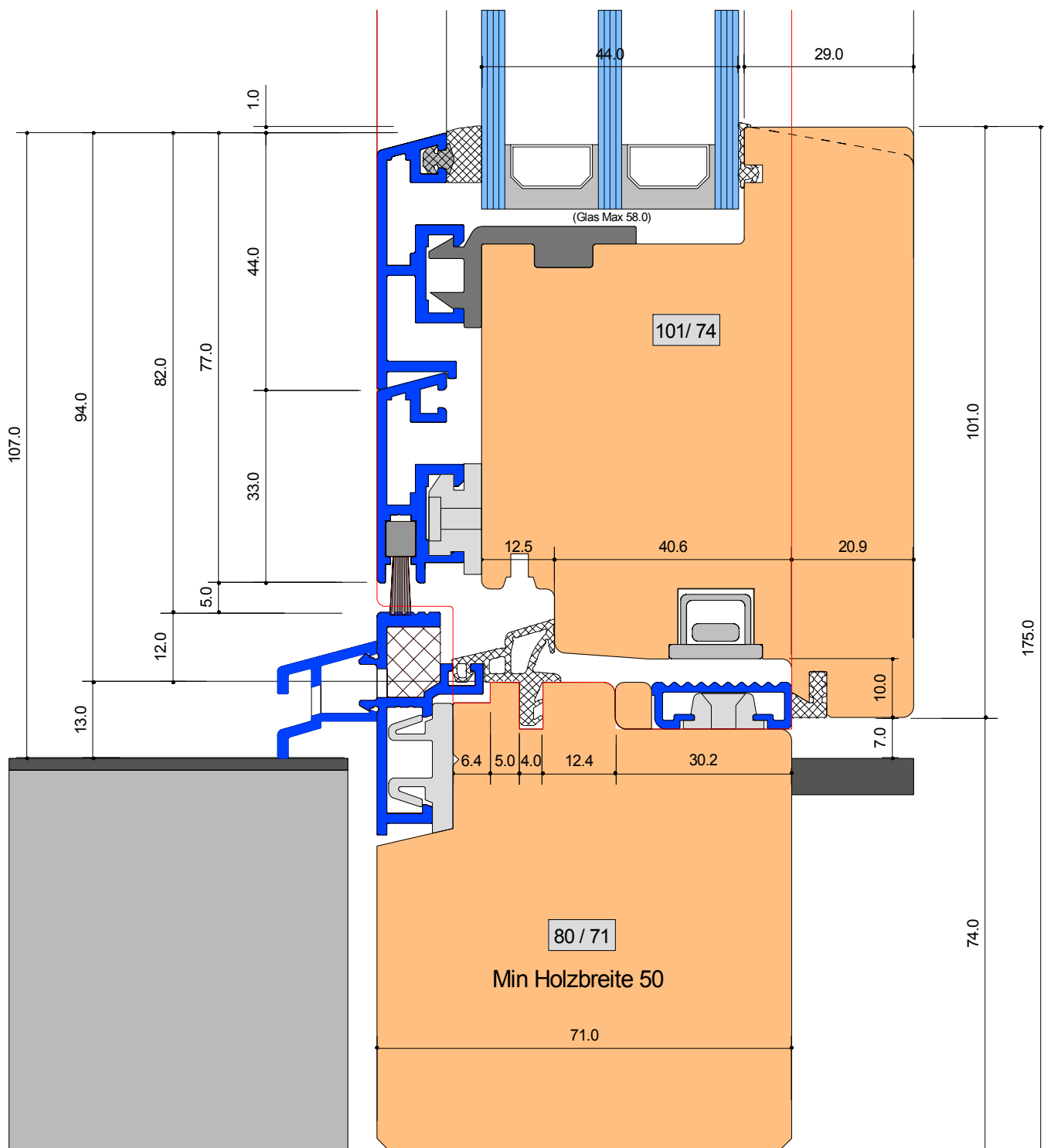

SYSTEM: L-3 71-74

Anschluss unten Rollstuhlgängig BT 101(109)
 Mit Flügelbreite 101 mm (-8.0)
 Grundprofil M1-GR 038-18 Roll / Steckteil Variabel

Detail-Nr :	L -3	D=022
-------------	------	-------



Von Euw Fenster AG
 Schoosstrasse 2
 6418 Rothenthurm

Tel 041 839 80 50
 Fax 041 839 80 60
 mail info@voneuw.ch

Ersteller: Adi von Euw
 Datum: 16.06.14
 Revidiert: 05.11.19

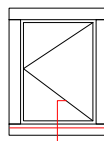

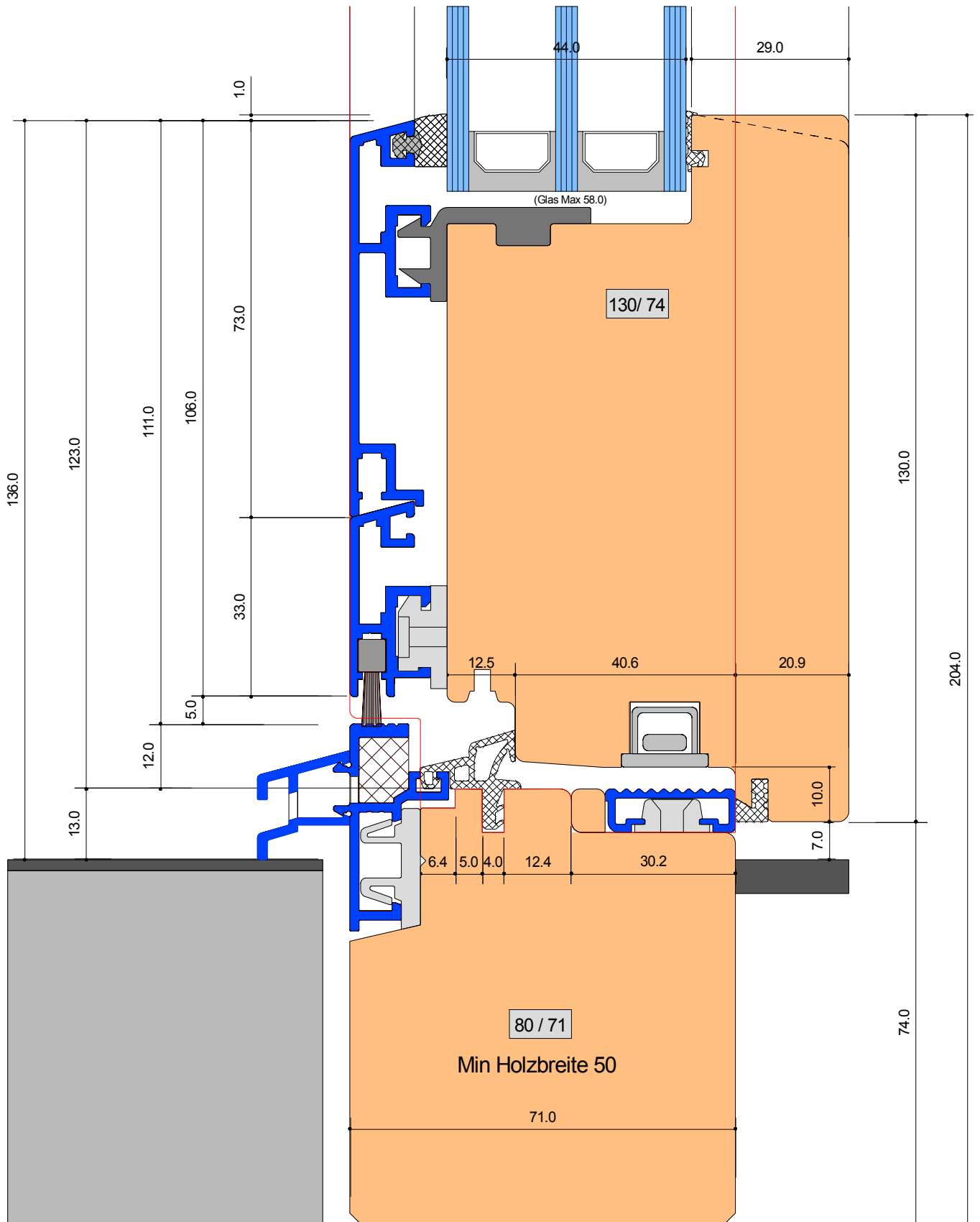

SYSTEM: L-3 71-74

Anschluss unten Rollstuhlgängig BT 130(138)
 Mit Flügelbreite 130 mm (-8.0)
 Grundprofil M1-GR 038-18 Roll / Steckteil Variabel

Detail-Nr :	L -3	D=023
-------------	------	-------



Von Euw Fenster AG
 Schoosstrasse 2
 6418 Rothenthurm

Tel 041 839 80 50
 Fax 041 839 80 60
 mail info@voneuw.ch

Ersteller: Adi von Euw
 Datum: 16.06.14
 Revidiert: 05.11.19

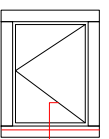

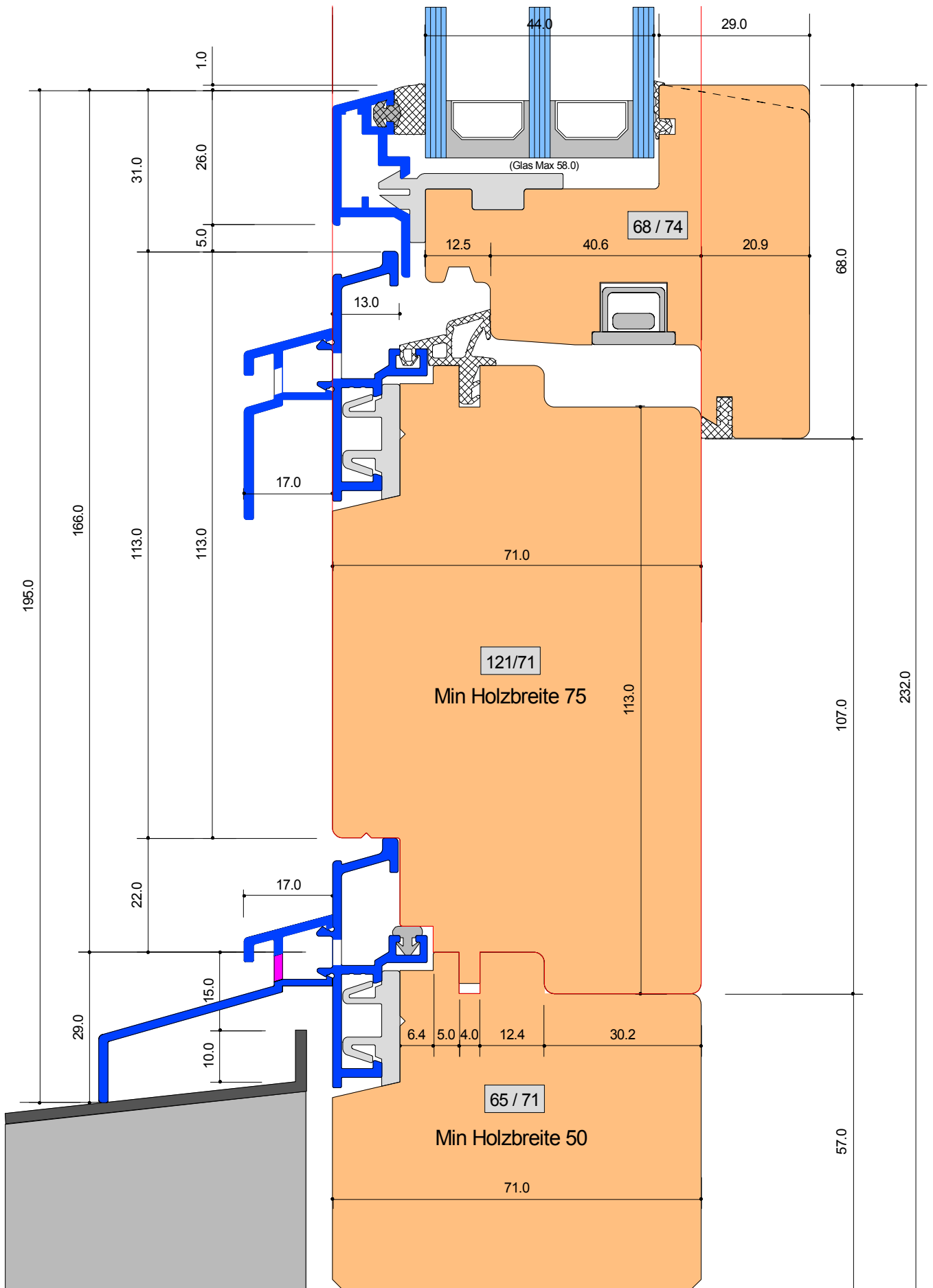

SYSTEM: L-3 71-74

Anschluss unten mit Einleimer
Wetterschenkel Typ RWS 045-013

Detail-Nr :	L -3	D=031
-------------	------	-------



Von Euw Fenster AG
Schoosstrasse 2
6418 Rothenthurm

Tel 041 839 80 50
Fax 041 839 80 60
mail info@voneuw.ch

Ersteller: Adi von Euw
Datum: 16.06.14
Revidiert:

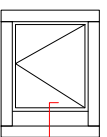

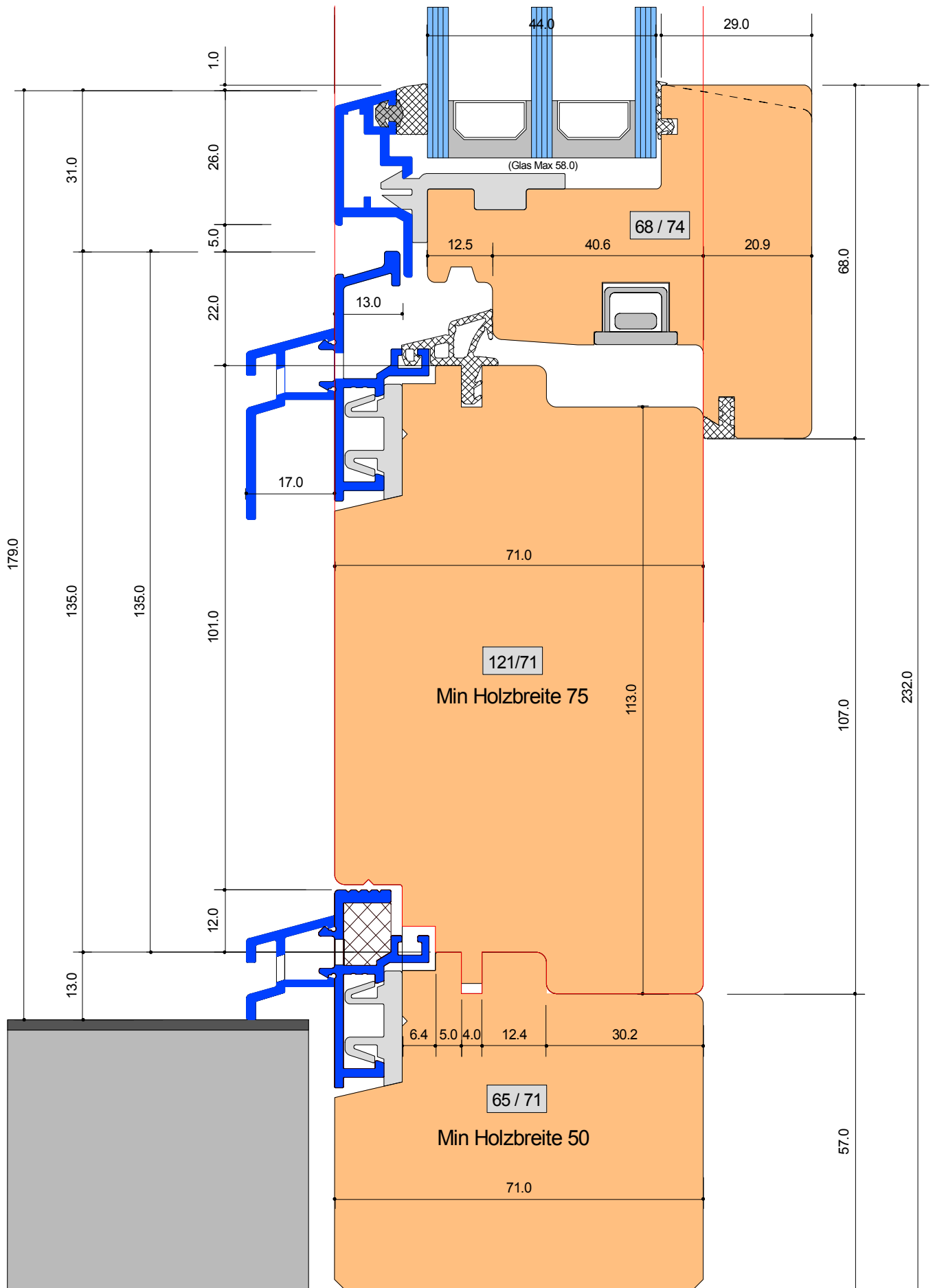

SYSTEM: L-3 71-74

Anschluss unten Rollstuhlgängig mit Einleimer
 Grundprofil M1-GR 038-18 Roll / Steckteil Variabel

Detail-Nr :	L -3	D=035
-------------	------	-------



Von Euw Fenster AG
 Schoosstrasse 2
 6418 Rothenthurm

Tel 041 839 80 50
 Fax 041 839 80 60
 mail info@voneuw.ch

Ersteller: Adi von Euw
 Datum: 16.06.14
 Revidiert: 05.11.19

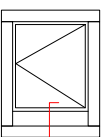

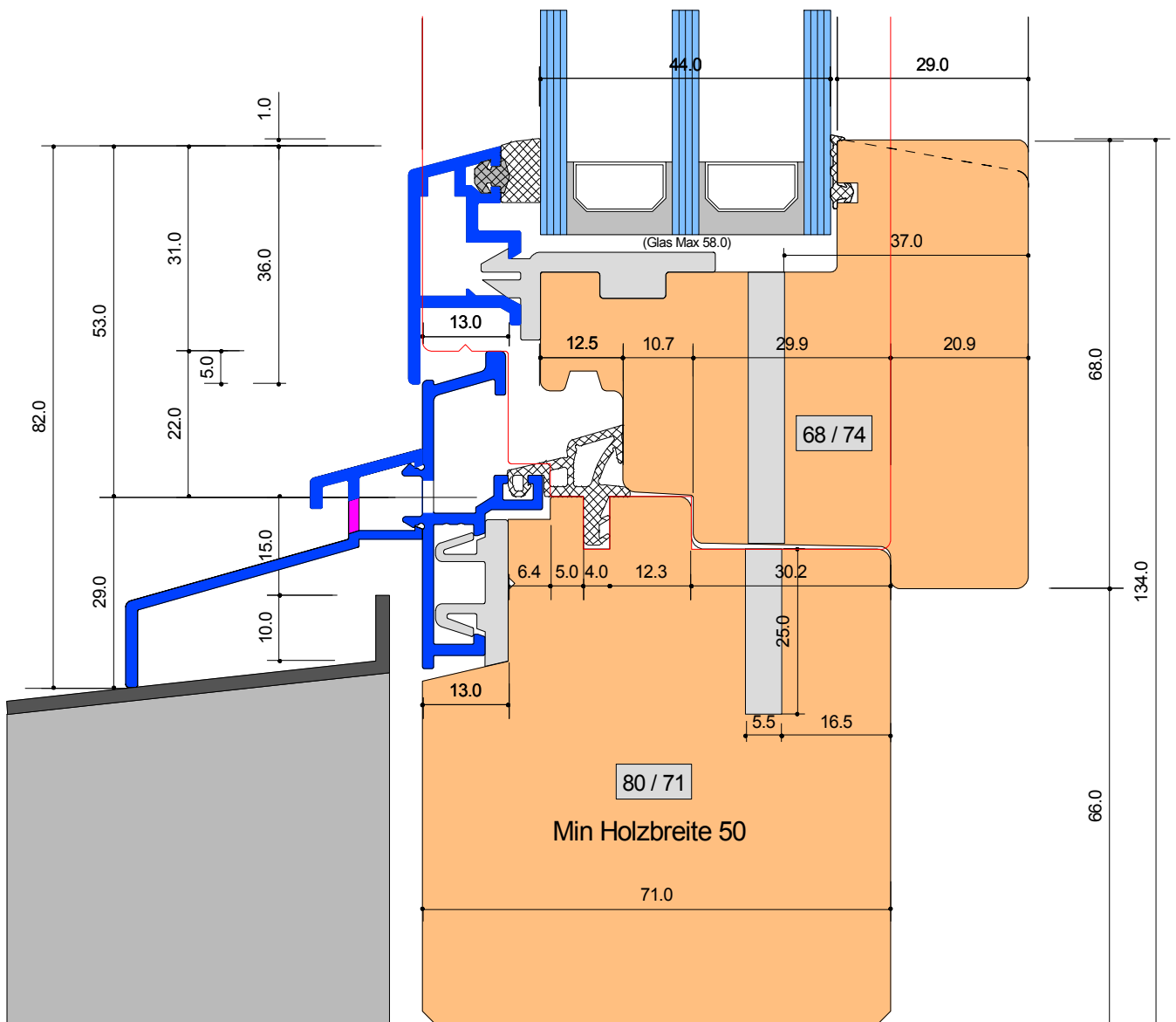

SYSTEM: L-3 71-74

Anschluss unten mit Alu Fensterbank
 Wetterschenkel Typ RWS 045-013
 Fest verglast von aussen eingesetzt Flg 68 mm

Detail-Nr :	L -3	D=041
-------------	------	-------



Von Euw Fenster AG
 Schoosstrasse 2
 6418 Rothenthurm

Tel 041 839 80 50
 Fax 041 839 80 60
 mail info@voneuw.ch

Ersteller: Adi von Euw
 Datum: 16.06.14
 Revidiert:

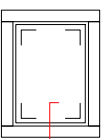

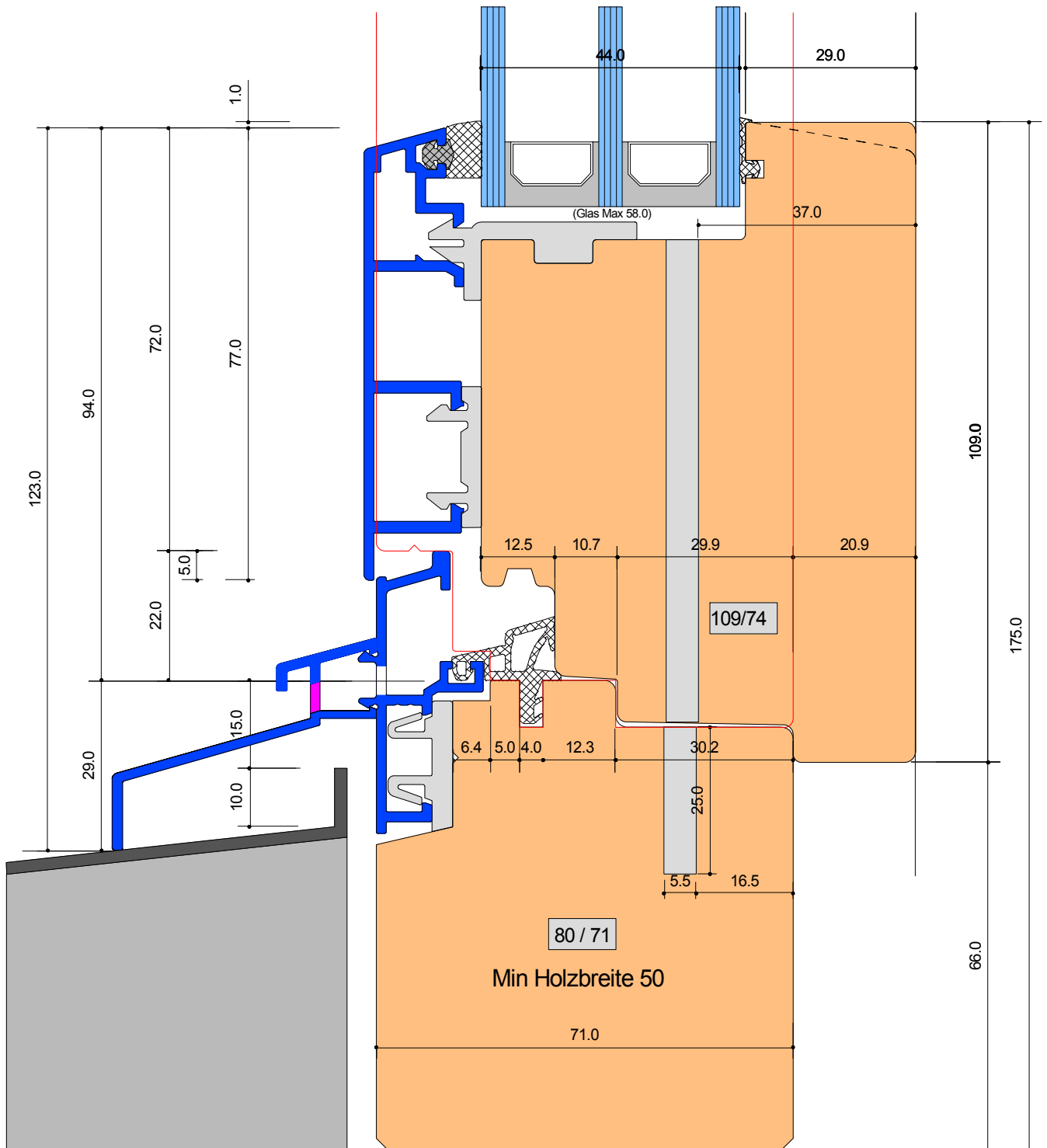

SYSTEM: L-3 71-74

Anschluss unten mit Alu Fensterbank
 Wetterschenkel Typ RWS 045-013
 Fest verglast von aussen eingesetzt Fig 109 mm

Detail-Nr :	L -3	D=042
-------------	------	-------



Von Euw Fenster AG
 Schoosstrasse 2
 6418 Rothenthurm

Tel 041 839 80 50
 Fax 041 839 80 60
 mail info@voneuw.ch

Ersteller: Adi von Euw
 Datum: 16.06.14
 Revidiert:

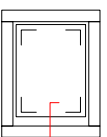

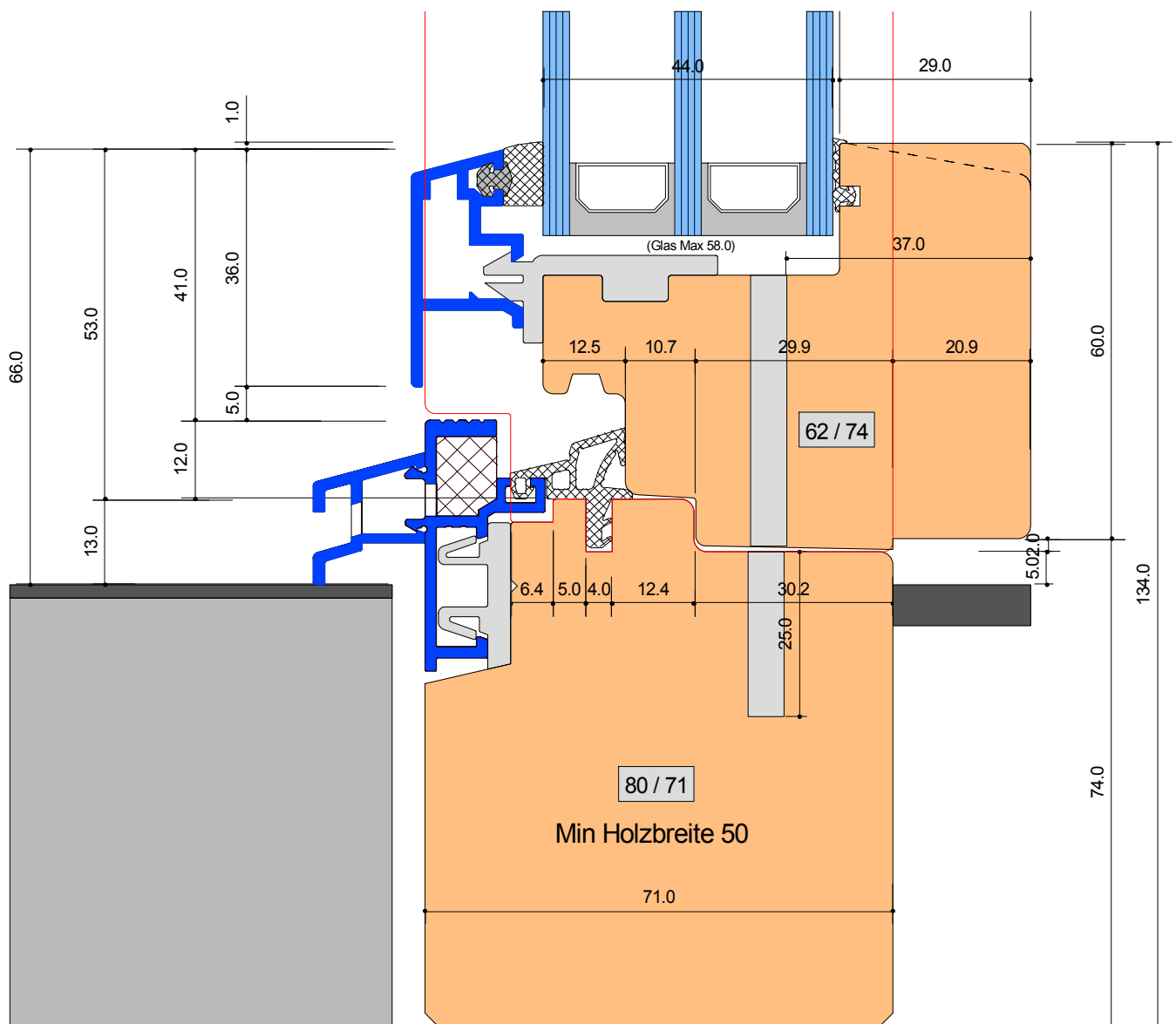

SYSTEM: L-3 71-74

Anschluss unten Rollstuhlgängig
 Mit Flügelbreite 62 mm(-6.0mm) Fest verg. v. aussen
 Grundprofil M1-GR 038-18 Roll / Steckteil Variabel

Detail-Nr :	L -3	D=045
-------------	------	-------



Von Euw Fenster AG
 Schoosstrasse 2
 6418 Rothenthurm

Tel 041 839 80 50
 Fax 041 839 80 60
 mail info@voneuw.ch

Ersteller: Adi von Euw
 Datum: 16.06.14
 Revidiert: 05.11.19

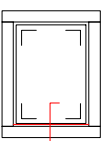

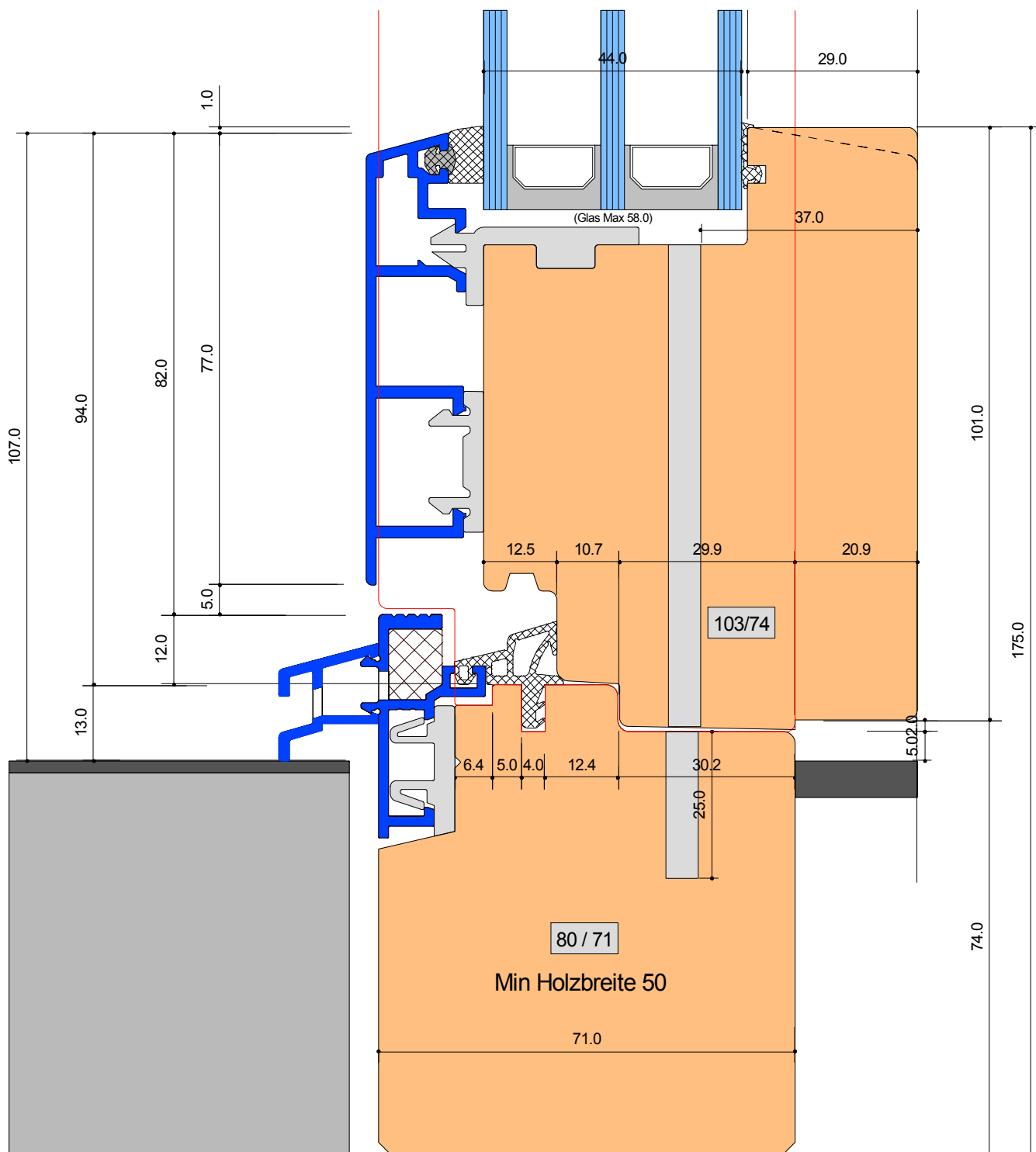

SYSTEM: L-3 71-74

Anschluss unten Rollstuhlgängig
 Mit Flügelbreite 103 (-6.0mm) Fest vergl. v. aussen
 Grundprofil M1-GR 038-18 Roll / Steckteil Variabel

Detail-Nr :	L -3	D=046
-------------	------	-------



Von Euw Fenster AG
 Schoosstrasse 2
 6418 Rothenthurm

Tel 041 839 80 50
 Fax 041 839 80 60
 mail info@voneuw.ch

Ersteller: Adi von Euw
 Datum: 16.06.14
 Revidiert: 05.11.19

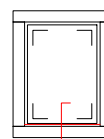

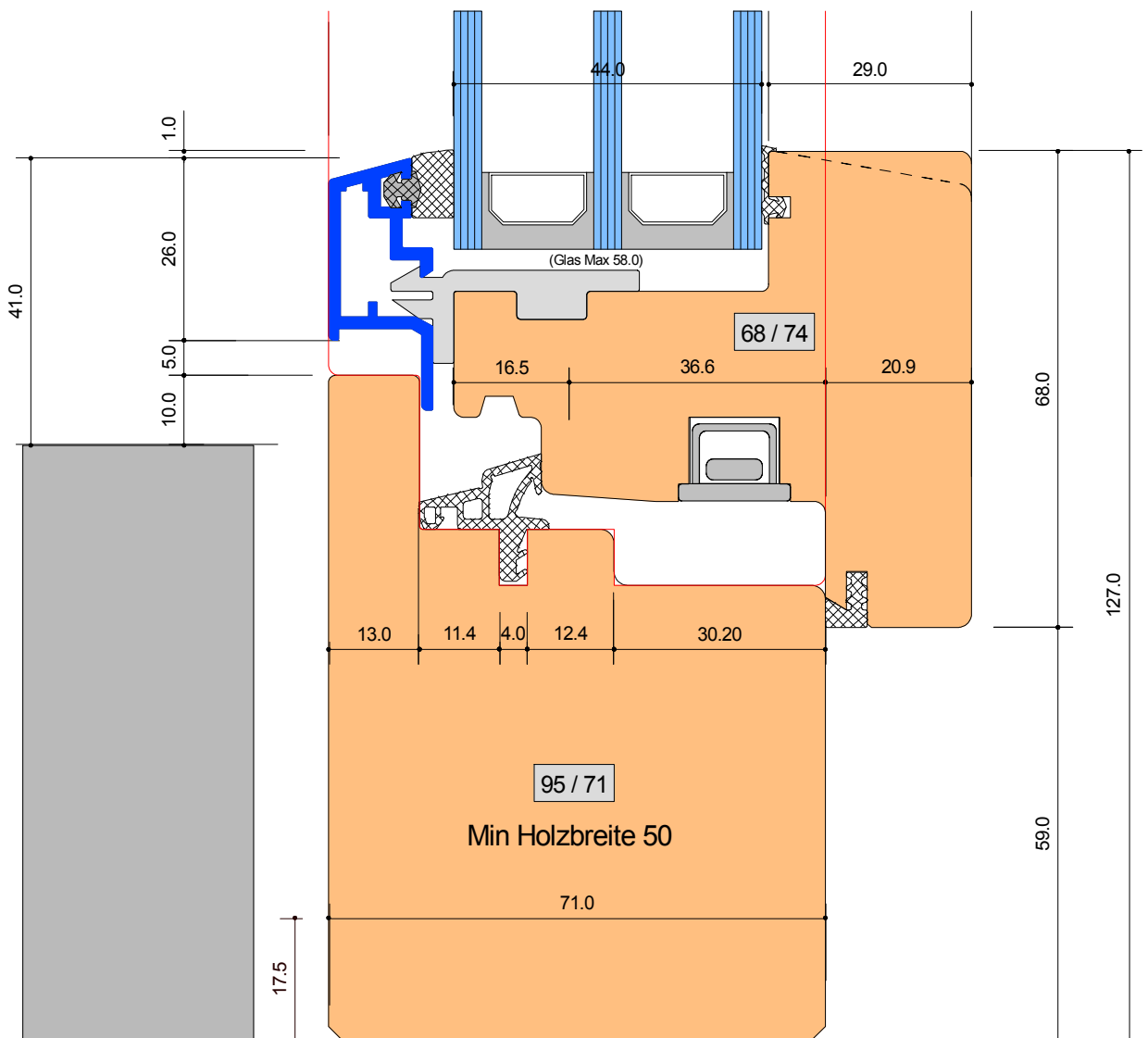

SYSTEM: L-3 71-74

Anschluss seitlich Standart Flg 68

Detail-Nr :	L -3	D=201
-------------	------	-------



Von Euw Fenster AG
Schoosstrasse 2
6418 Rothenthurm

Tel 041 839 80 50
Fax 041 839 80 60
mail info@voneuw.ch

Ersteller: Adi von Euw
Datum: 21.11.15
Revidiert:

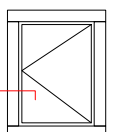

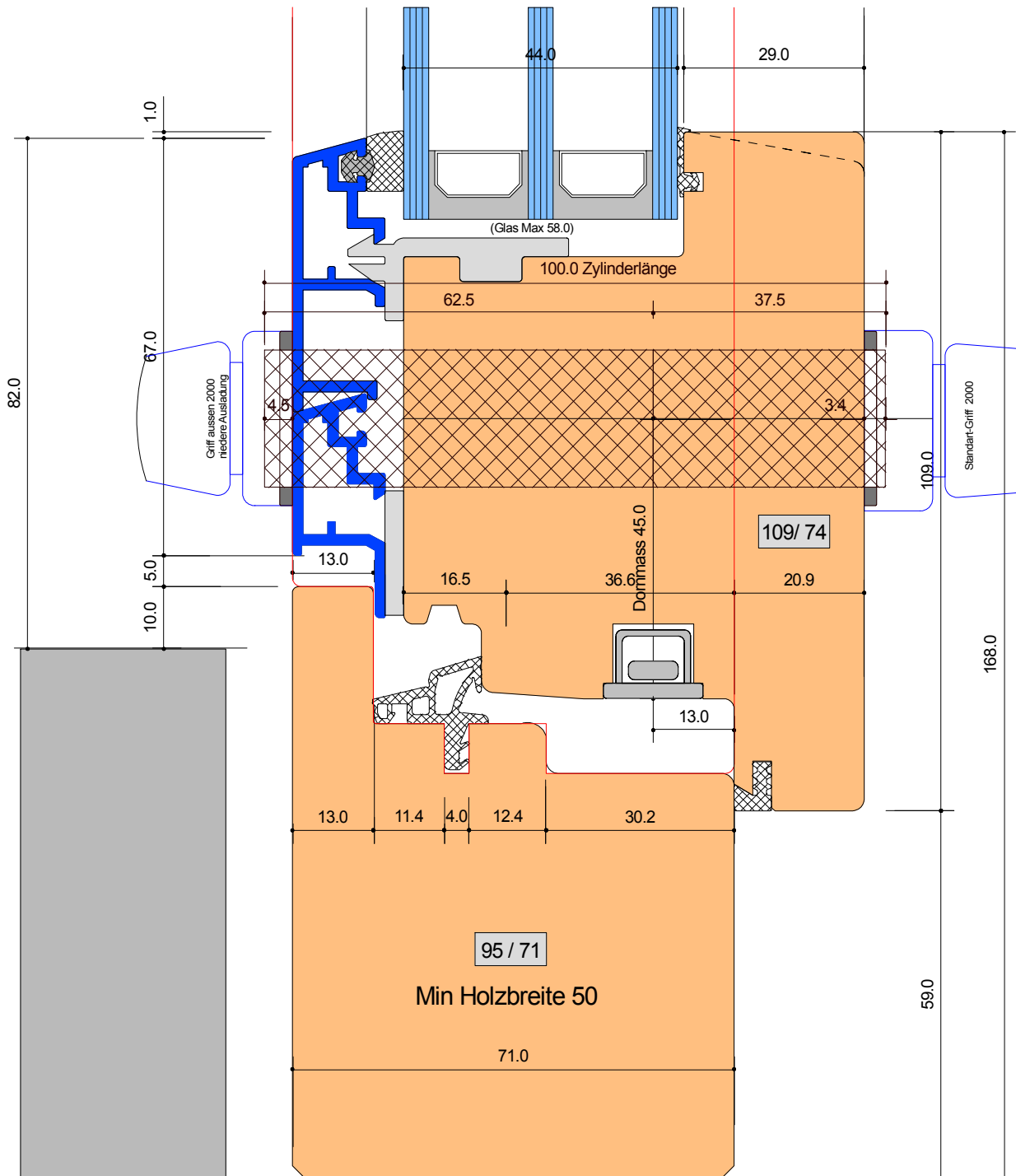

SYSTEM: L-3 71-74

Anschluss seitlich Standard Fig 109 mm
 Verschluss durchg. D=45.0 mm Griff m. Knopf/Schlüssel
 Variante: Verschluss durchg. D=45.0 mm mit Zylinder

Detail-Nr :	L - 3	D=205
-------------	-------	-------



Von Euw Fenster AG
 Schoosstrasse 2
 6418 Rothenthurm

Tel 041 839 80 50
 Fax 041 839 80 60
 mail info@voneuw.ch

Ersteller: Adi von Euw
 Datum: 16.06.16
 Revidiert:

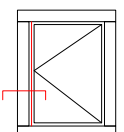

Variante 1
 Schutzschild Glutz
 ES1 5430S mit Zyl.
 Schutzrosette (10-14 mm)

Variante 1
 Innenschild Glutz
 ES1 5435C.2 gerade

Variante 2
 Rund-Schutzrosette Glutz
 ES1 5330.2S-RS mit Schutz-
 Einsatz (7-12 einwärts)

Variante 2
 Rund-Rosette innen Glutz
 5330.C mit Grundplatte

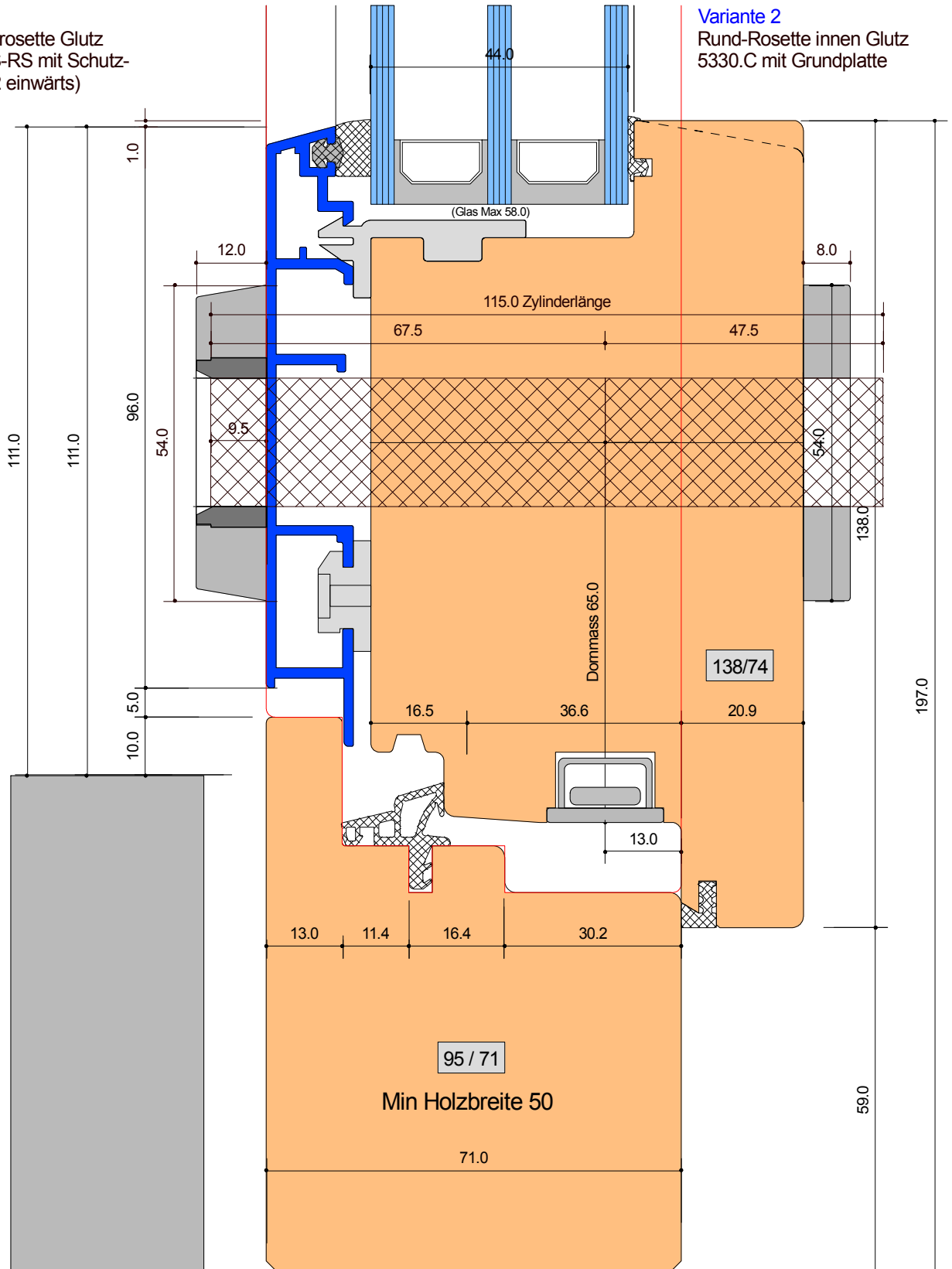

SYSTEM: L-3 71-74

Anschluss seitlich mit Flügel 138 mm
 mit Haustürverschluss D=65 mm
 mit Sicherheitslangschild Glutz 5430S/5435C.2
 mit Rund-Ros Glutz ES1 5330.2S-RS/5330C

Detail-Nr :	L - 3	D=210
-------------	-------	-------



Von Euw Fenster AG
 Schoosstrasse 2
 6418 Rothenthurm

Tel 041 839 80 50
 Fax 041 839 80 60
 mail info@voneuw.ch

Ersteller: Adi von Euw
 Datum: 16.06.16
 Revidiert:

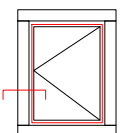

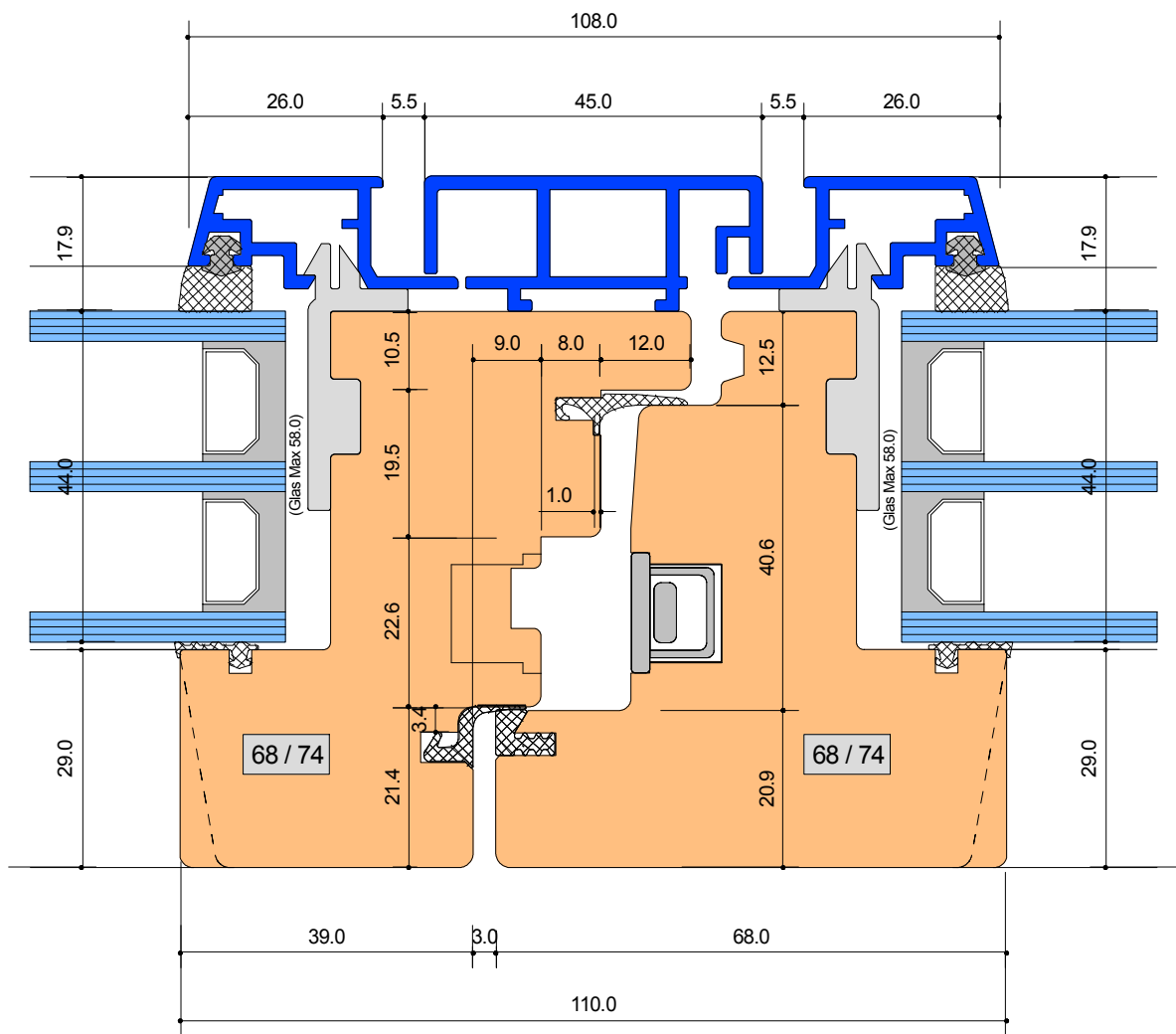

SYSTEM: L-3 71-74

Anschluss seitlich Standart Flg 68

Detail-Nr :	L -3	D=301
-------------	------	-------



Von Euw Fenster AG
Schoosstrasse 2
6418 Rothenthurm

Tel 041 839 80 50
Fax 041 839 80 60
mail info@voneuw.ch

Ersteller: Adi von Euw
Datum: 21.11.15
Revidiert:

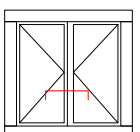

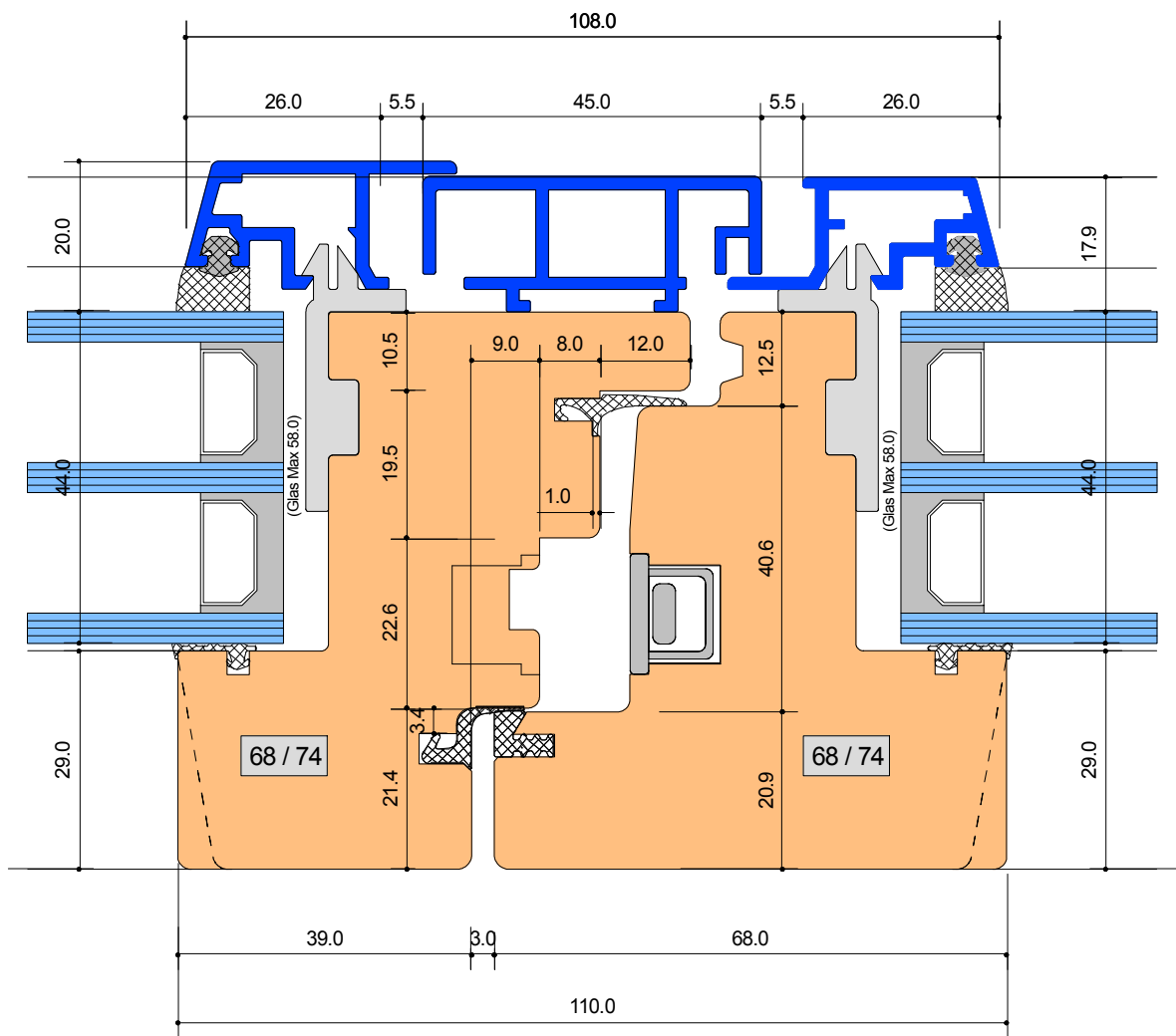

SYSTEM: L-3 71-74

Mittelpartie einseitig mit fest vergl. Flg v. aussen

Detail-Nr :	L -3	D=310
-------------	------	-------



Von Euw Fenster AG
Schoosstrasse 2
6418 Rothenthurm

Tel 041 839 80 50
Fax 041 839 80 60
mail info@voneuw.ch

Ersteller: Adi von Euw
Datum: 21.11.15
Revidiert:

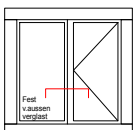

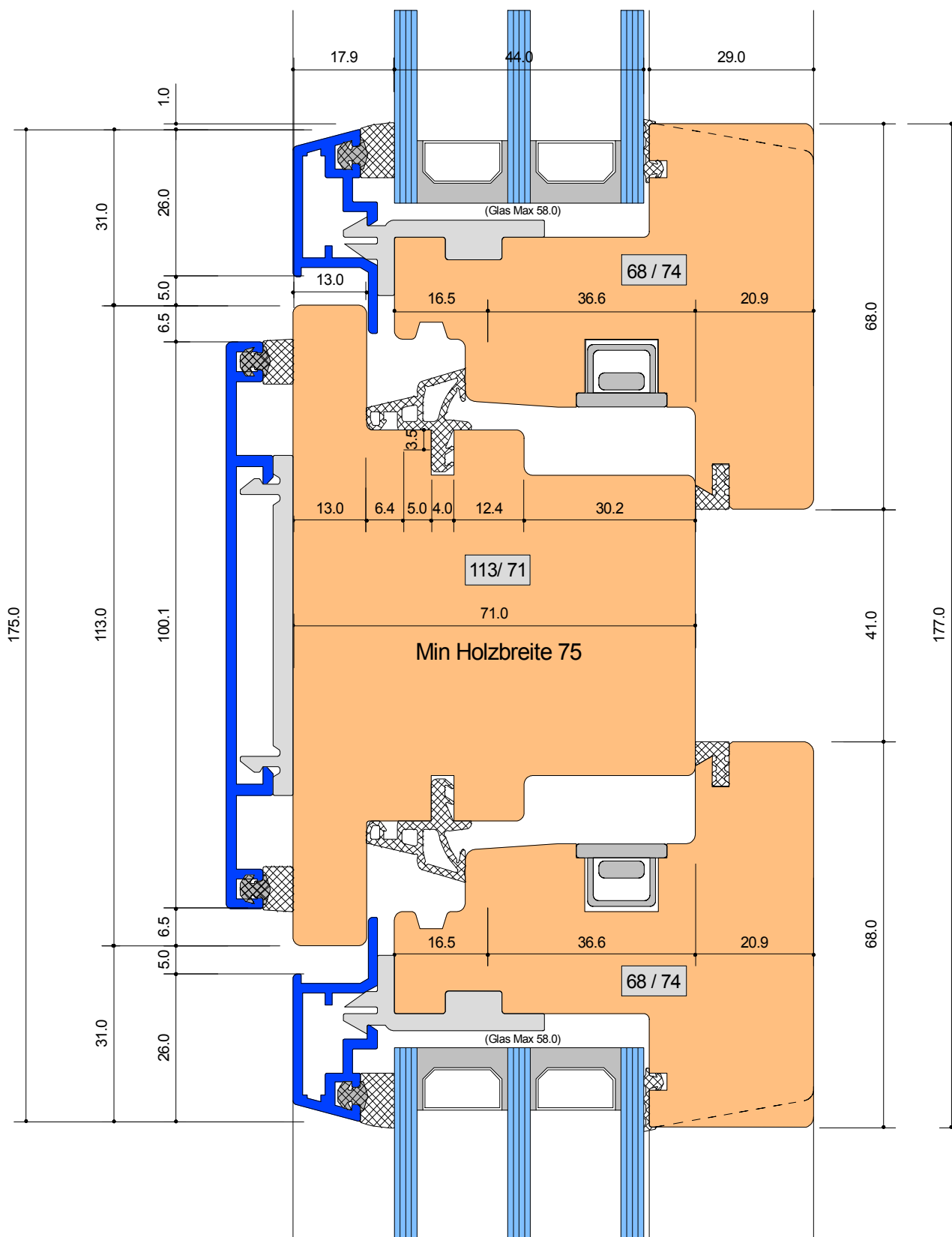

SYSTEM: L-3 71-74

Setzholz 113 mm
 Alu Klemmprofil 100 mm optional

Detail-Nr :	L -3	D=401
-------------	------	-------

Ersteller: Adi von Euw
 Datum: 21.11.15
 Revidiert:



Von Euw Fenster AG
 Schoosstrasse 2
 6418 Rothenthurm

Tel 041 839 80 50
 Fax 041 839 80 60
 mail info@voneuw.ch

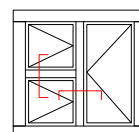

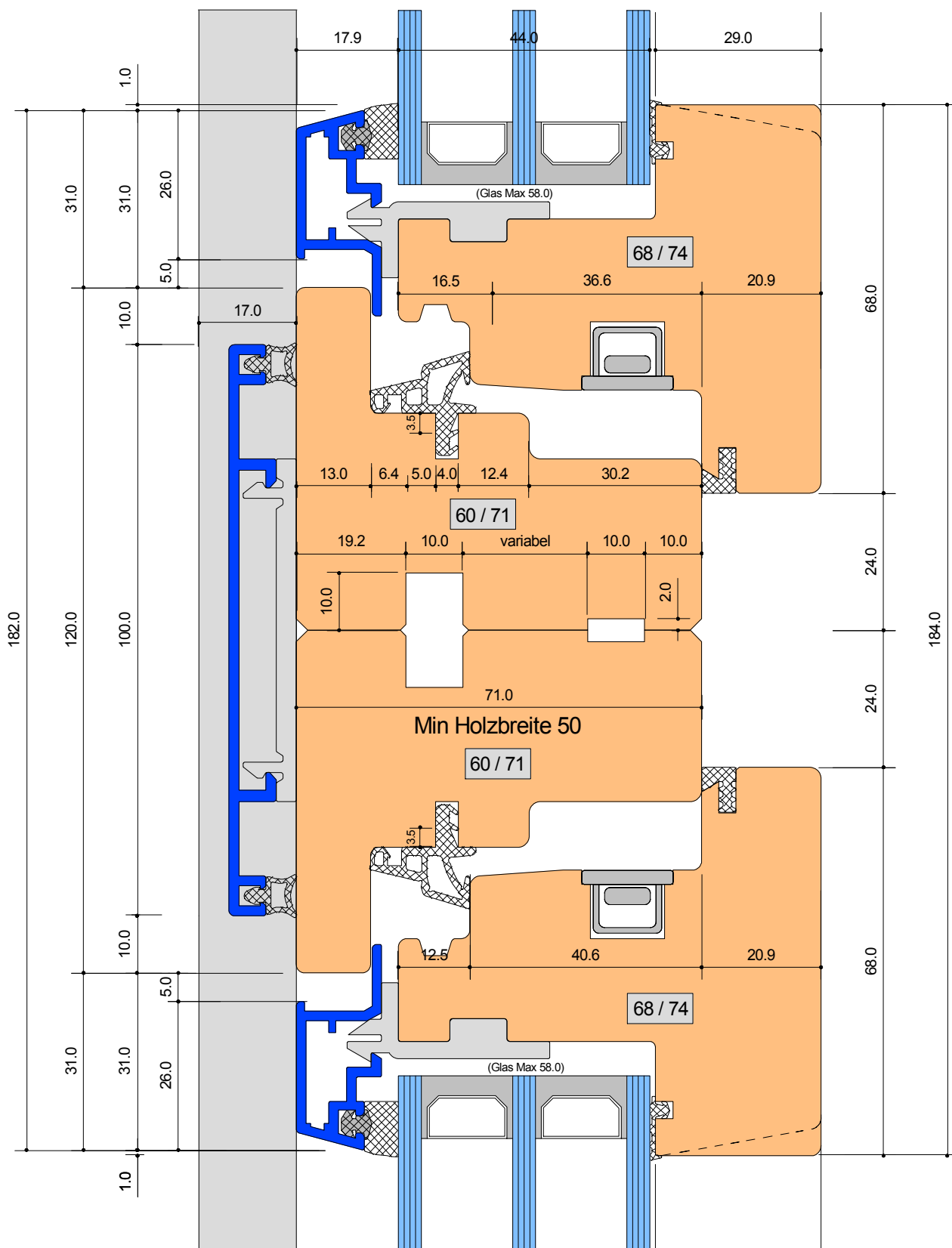

SYSTEM: L-3 71-74

Kombinationszusammenbau mit Nut + Feder

Detail-Nr :	L - 3	D=405
-------------	-------	-------

Ersteller: Adi von Euw
 Datum: 21.11.15
 Revidiert:



Von Euw Fenster AG
 Schoosstrasse 2
 6418 Rothenthurm

Tel 041 839 80 50
 Fax 041 839 80 60
 mail info@voneuw.ch

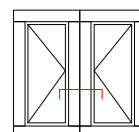

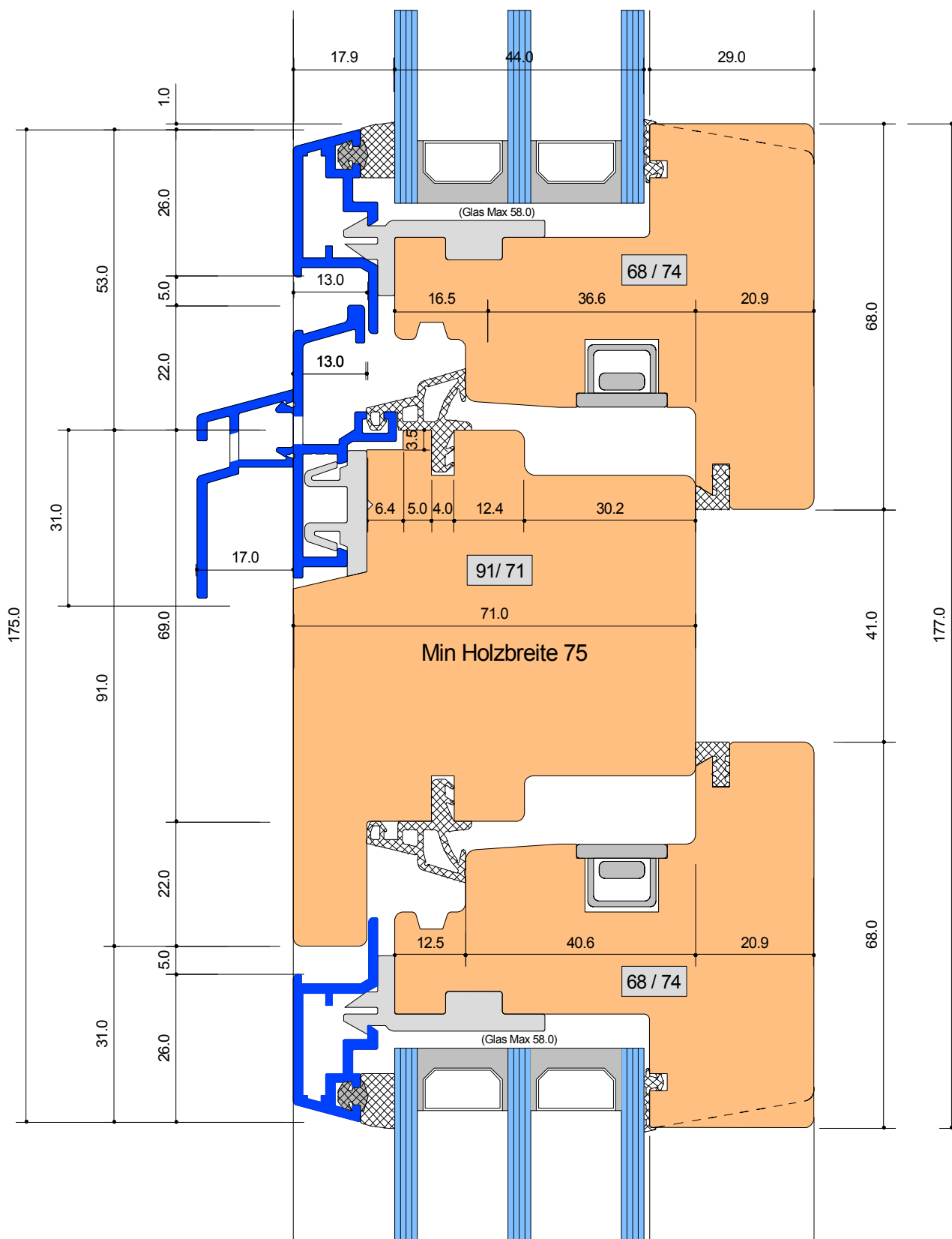

SYSTEM: L-3 71-74

Kämpfer

Detail-Nr :	L - 3	D=501
-------------	-------	-------

Ersteller: Adi von Euw
 Datum: 21.11.15
 Revidiert:



Von Euw Fenster AG
 Schoosstrasse 2
 6418 Rothenthurm

Tel 041 839 80 50
 Fax 041 839 80 60
 mail info@voneuw.ch

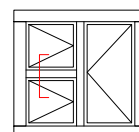

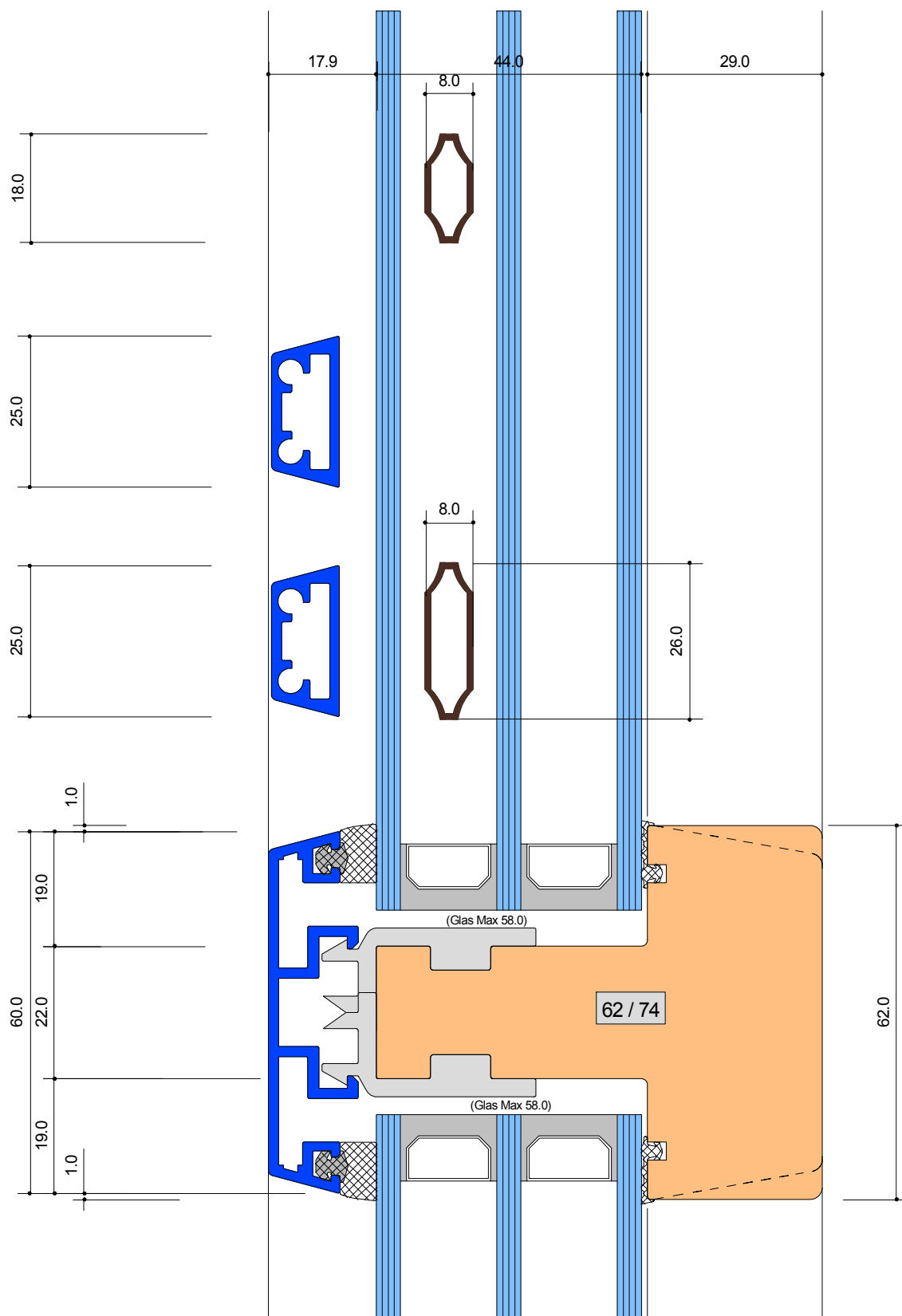

SYSTEM: L-3 71-74

Sprossen glastrennend 62 mm Alu 60 mm
 Vorgesetzte Alu-Spr. 25 mm +Zw.Glas Sprosse 26 mm
 Vorgesetzte Alu-Spr. 25 mm
 Zwischenglas -Sprosse 18 mm

Detail-Nr :	L - 3	D=601
-------------	-------	-------



Von Euw Fenster AG
 Schoosstrasse 2
 6418 Rothenthurm

Tel 041 839 80 50
 Fax 041 839 80 60
 mail info@voneuw.ch

Ersteller: Adi von Euw
 Datum: 21.11.15
 Revidiert:

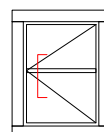

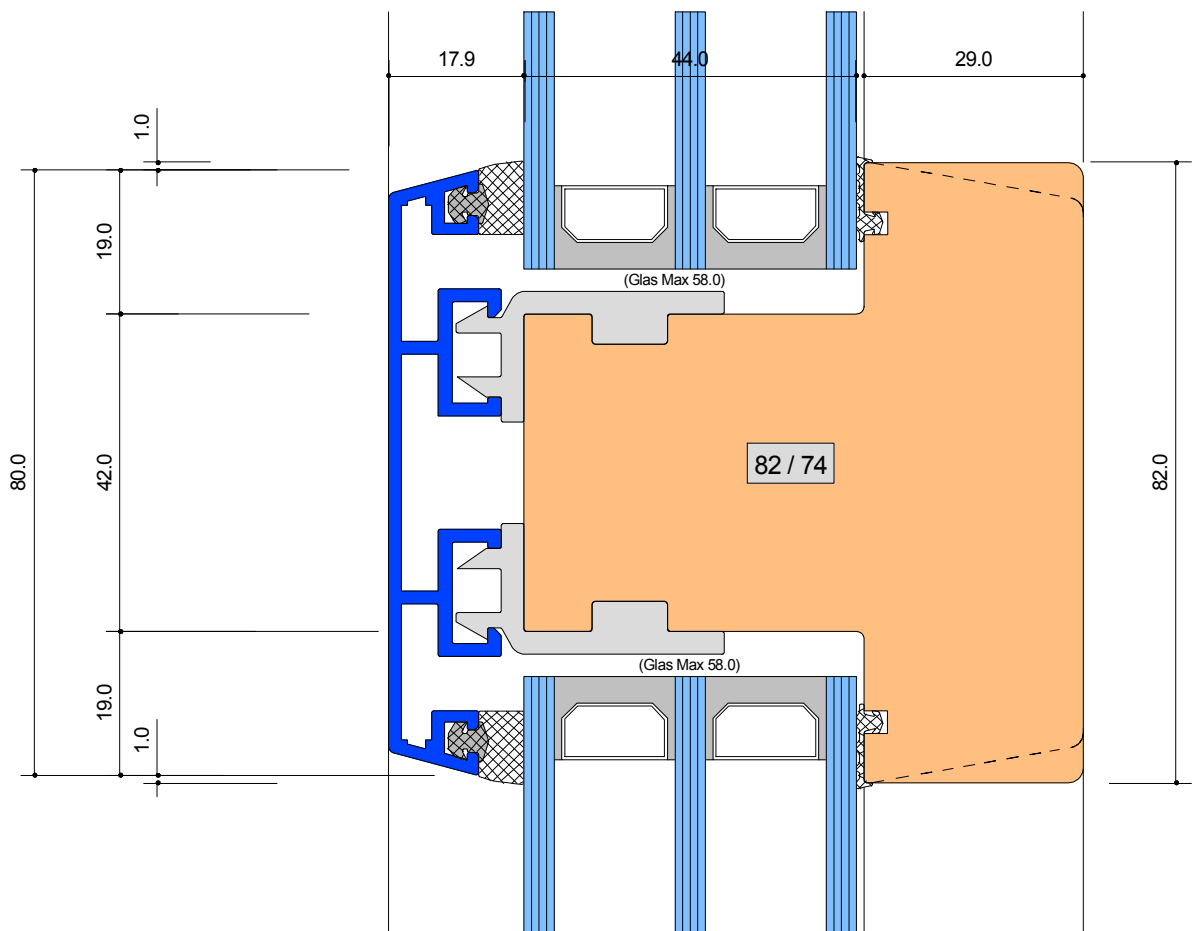

SYSTEM: L-3 71-74

Sprossen glastrennend 80 mm

Detail-Nr :	L -3	D=602
-------------	------	-------



Von Euw Fenster AG
Schoosstrasse 2
6418 Rothenthurm

Tel 041 839 80 50
Fax 041 839 80 60
mail info@voneuw.ch

Ersteller: Adi von Euw
Datum: 21.11.15
Revidiert:

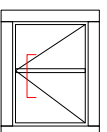

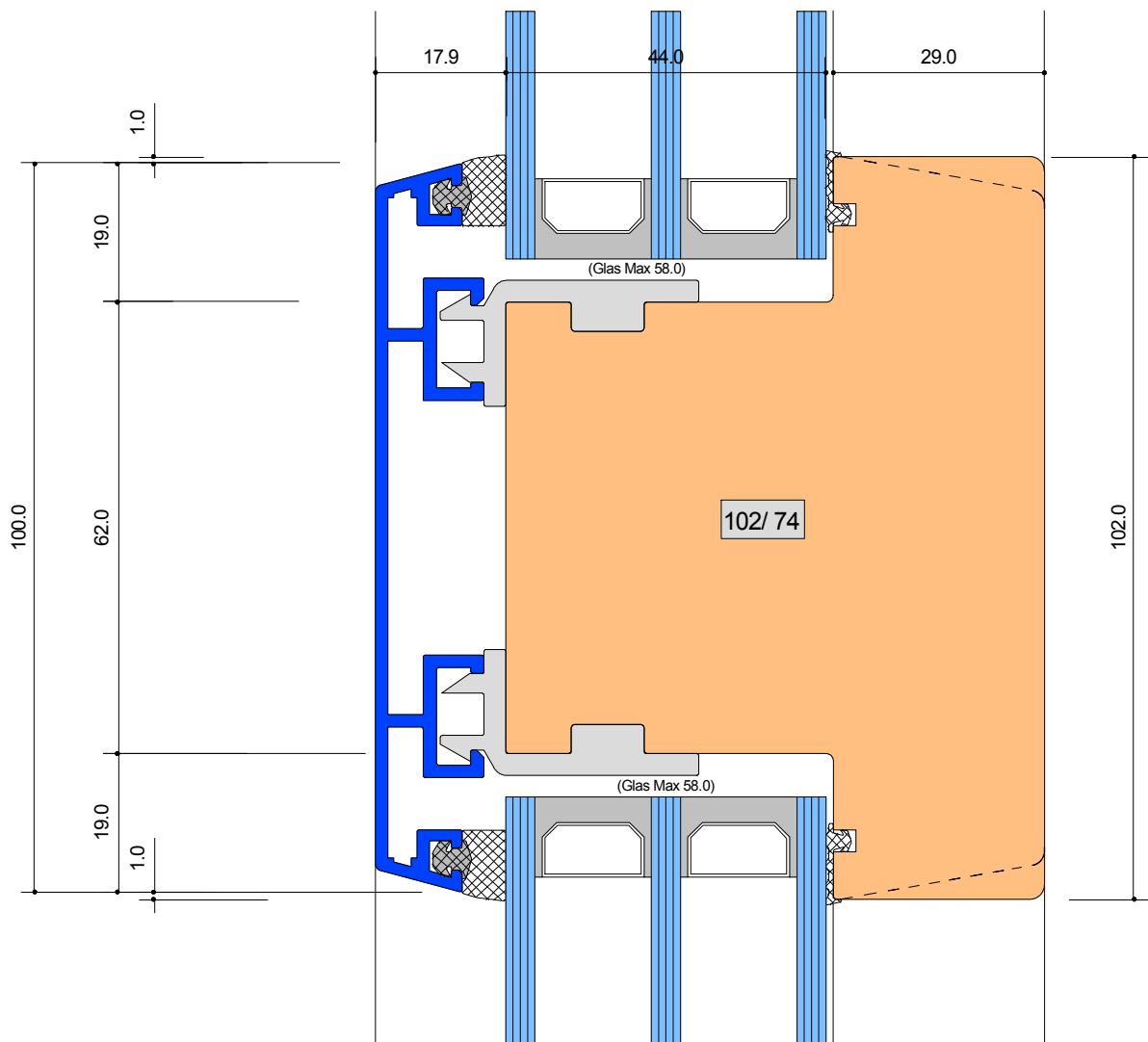

SYSTEM: L-3 71-74

Sprossen glastrennend 100 mm

Detail-Nr :	L - 3	D=603
-------------	-------	-------



Von Euw Fenster AG
 Schoosstrasse 2
 6418 Rothenthurm

Tel 041 839 80 50
 Fax 041 839 80 60
 mail info@voneuw.ch

Ersteller: Adi von Euw
 Datum: 21.11.15
 Revidiert:

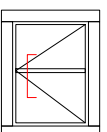

N69202 0.353 g/m1
 X1-ST 045-008 (roh+eloxiert)
 Fräsung 30.0 x 5.0 mm
 Abstand 125/25x250/125

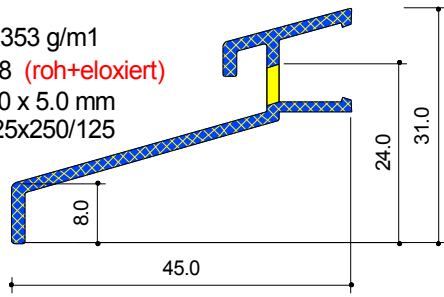

N70584 0.295 g/m1
 X1-ST 017-021 (eloxiert)
 Fräsung 30.0 x 5.0 mm
 Abstand 125/25x250/125

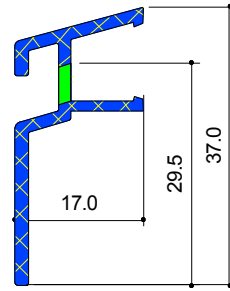

N74261 0.620 g/m1
 X1-ST 017-084 (eloxiert)
 Fräsung 30.0 x 5.0 mm
 Abstand 125/25x250/125

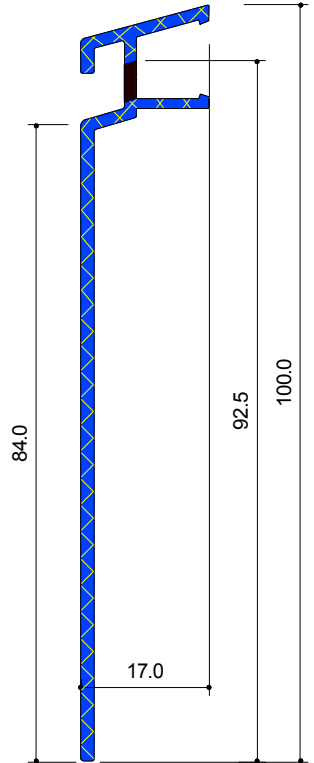

N74777 0.378 g/m1
 X1-ST 045-013 (roh+eloxiert)
 Fräsung 30.0 x 5.0 mm
 Abstand 125/25x250/125

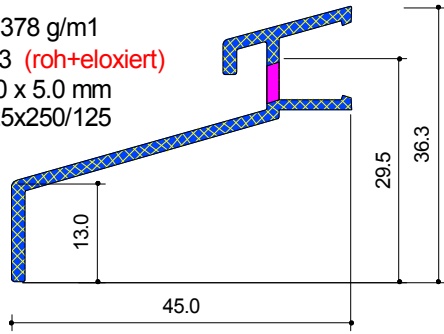

N70585 0.393 g/m1
 X1-ST 017-041 (eloxiert)
 Fräsung 30.0 x 5.0 mm
 Abstand 125/25x250/125

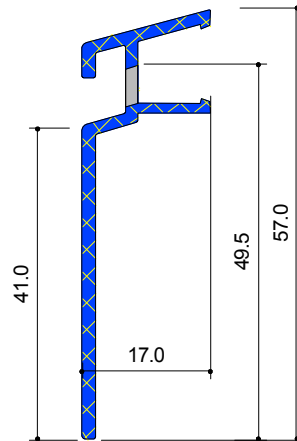

N70586 0.445 g/m1
 X1-ST 065-008 (roh+eloxiert)
 Fräsung 30.0 x 5.0 mm
 Abstand 125/25x250/125

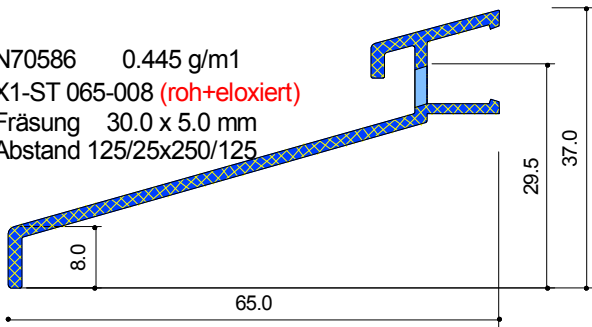

N74260 0.561 g/m1
 X1-ST 065-030 (eloxiert)
 Fräsung 30.0 x 5.0 mm
 Abstand 125/25x250/125

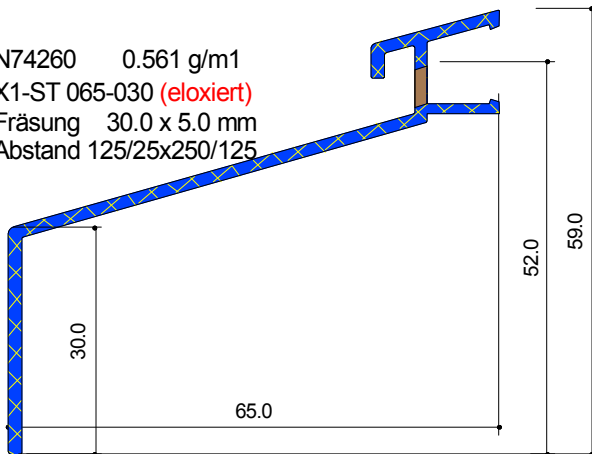

L49108 0.450 g/m1
 M1-GR 038-18 Roll (roh)
 Fräsung 30.0 x 5.0 mm
 Abstand 50/32x200/50

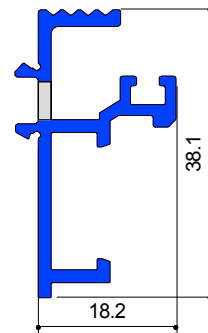

SYSTEM: *H, L, M, R*

Steckteil-Profilübersicht



Detail-Nr : A-1 D=100



Von Euw Fenster AG
 Schoosstrasse 2
 6418 Rothenthurm

Tel 041 839 80 50
 Fax 041 839 80 60
 mail info@voneuw.ch

Ersteller: Adi von Euw
 Datum: 11.10.19

-  Alu *roh* (Lager)
-  Alu *farblos elox.* (Lager)
-  Alu *Roh + farblos elox.* (Lager)