

# Holz-Metallfenster

System : L-1 63/66 „light class“

## Vermasste Standard-Details

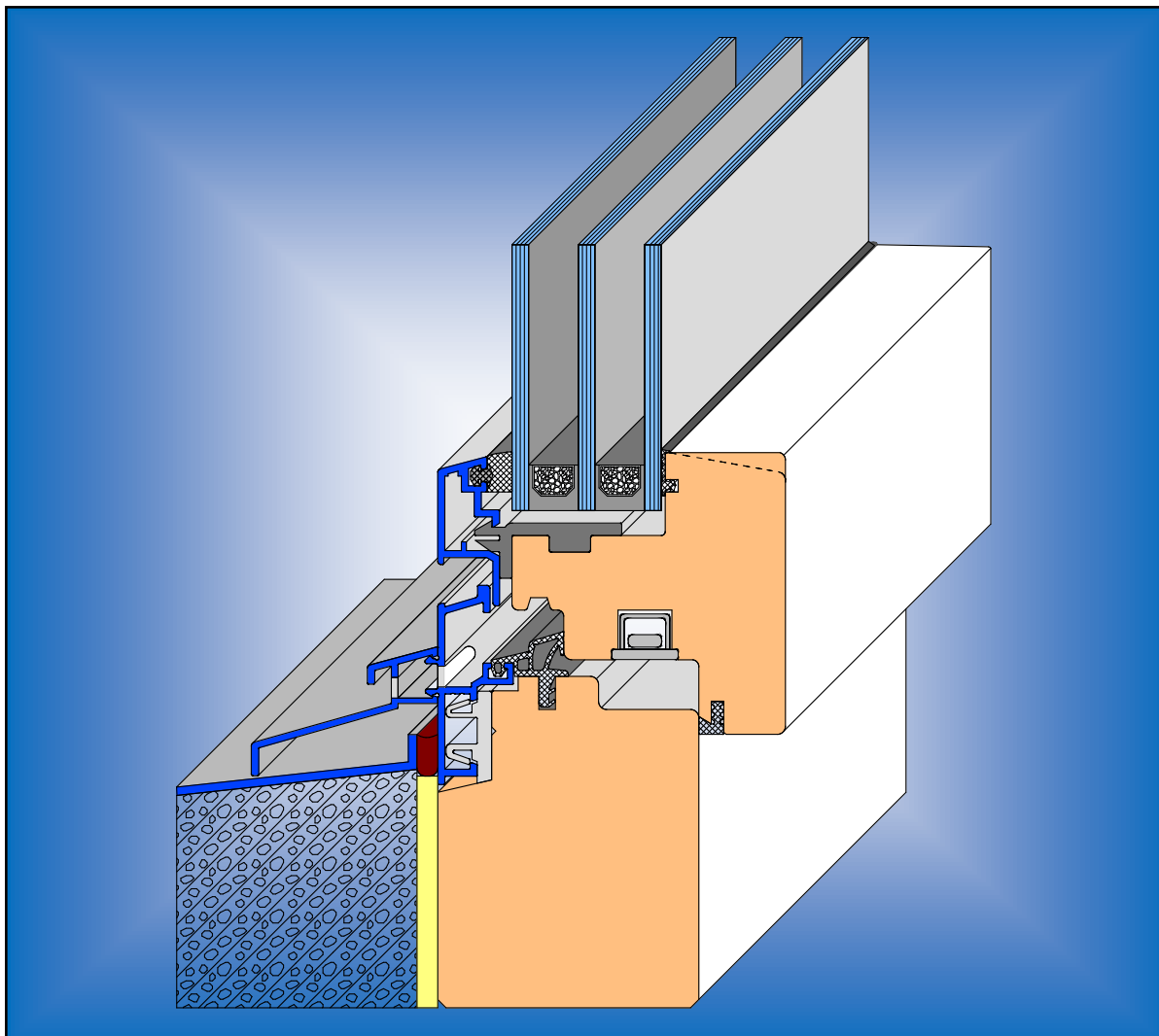

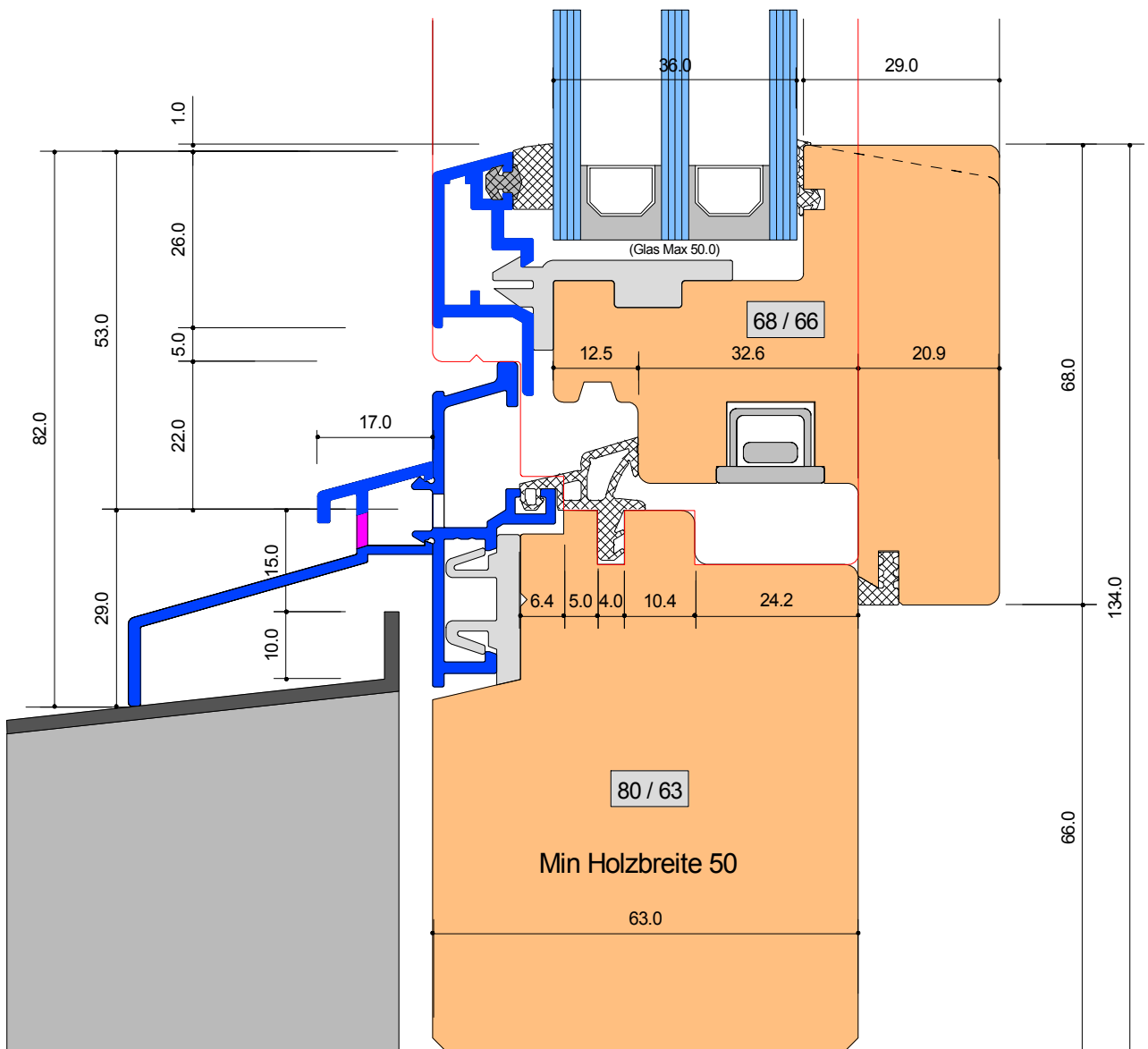

**SYSTEM: L-1 63-66**

Anschluss unten mit Alu Fensterbank  
Wetterschenkel Typ RWS 045-013

Detail-Nr :	L-1	D=001
-------------	-----	-------



Von Euw Fenster AG  
Schoosstrasse 2  
6418 Rothenthurm

Tel 041 839 80 50  
Fax 041 839 80 60  
mail info@voneuw.ch

Ersteller: Adi von Euw  
Datum: 16.06.14  
Revidiert:

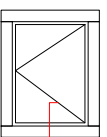

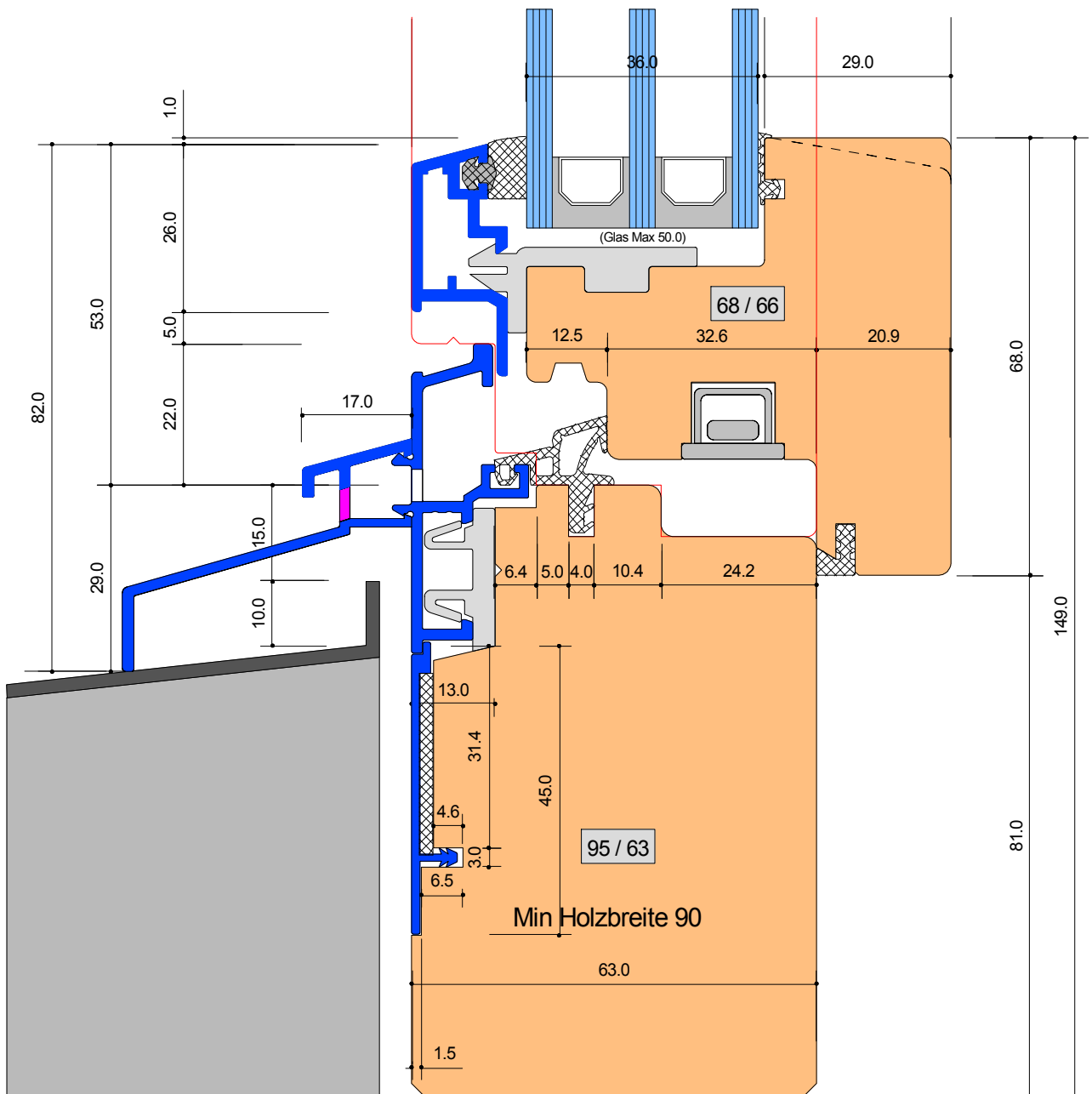

## SYSTEM: L-1 63-66

Anschluss unten mit Alu Fensterbank  
 Wetterschenkel Typ RWS 045-013  
 mit Zusatzprofil für Abklebung bauseits

Detail-Nr :	L-1	D=001Z
-------------	-----	--------



Von Euw Fenster AG  
 Schoosstrasse 2  
 6418 Rothenthurm

Tel 041 839 80 50  
 Fax 041 839 80 60  
 mail info@voneuw.ch

Ersteller: Adi von Euw  
 Datum: 16.06.14  
 Revidiert:

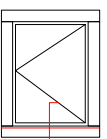

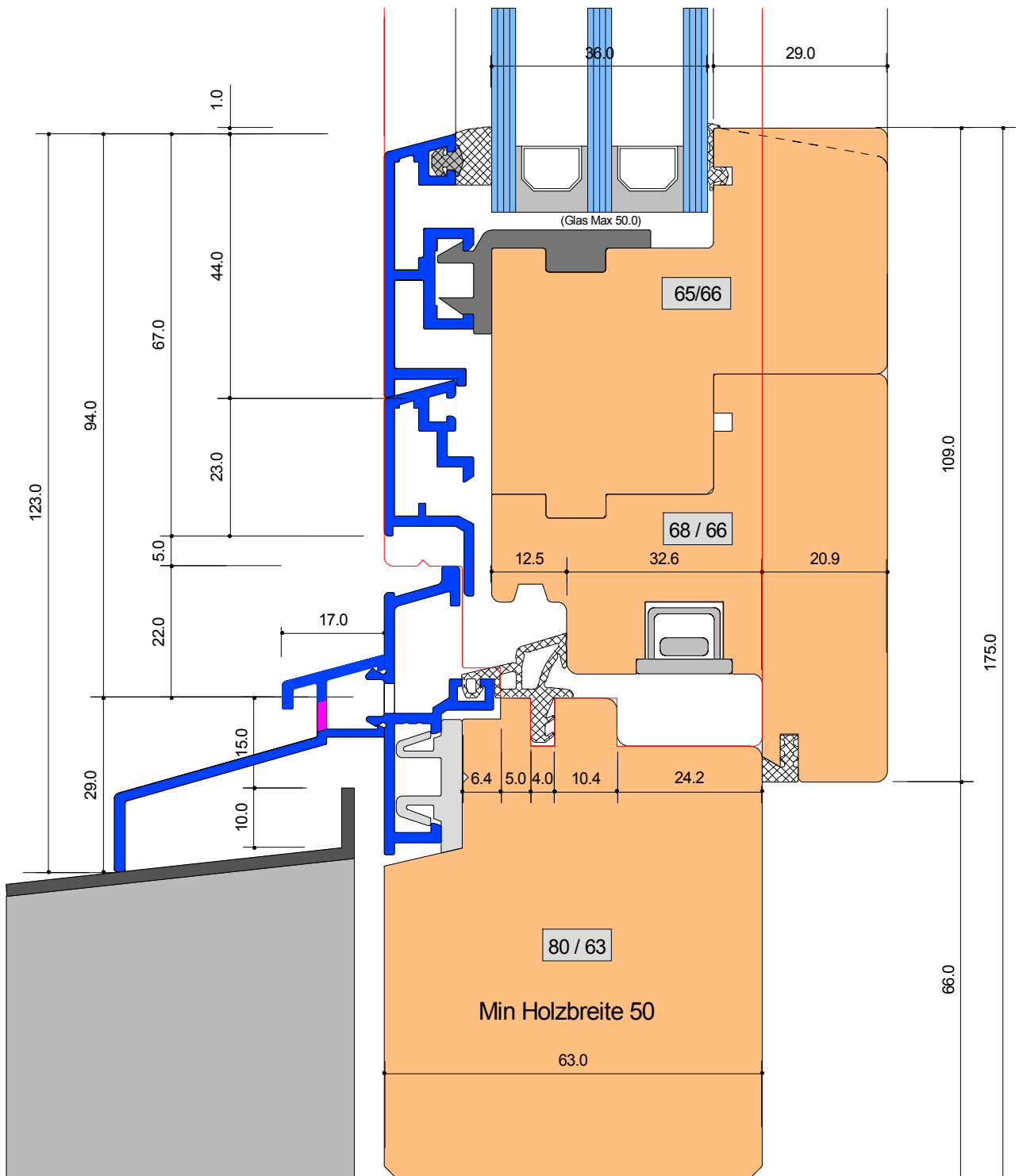

## SYSTEM: L-1 63-66

Anschluss unten BT 109 mm breit  
Wetterschenkel Typ RWS 045-013

Detail-Nr :	L - 1	D=005
-------------	-------	-------



Von Euw Fenster AG  
Schoosstrasse 2  
6418 Rothenthurm

Tel 041 839 80 50  
Fax 041 839 80 60  
mail info@voneuw.ch

Ersteller: Adi von Euw  
Datum: 16.06.14  
Revidiert: 11.10.19

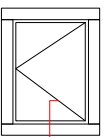

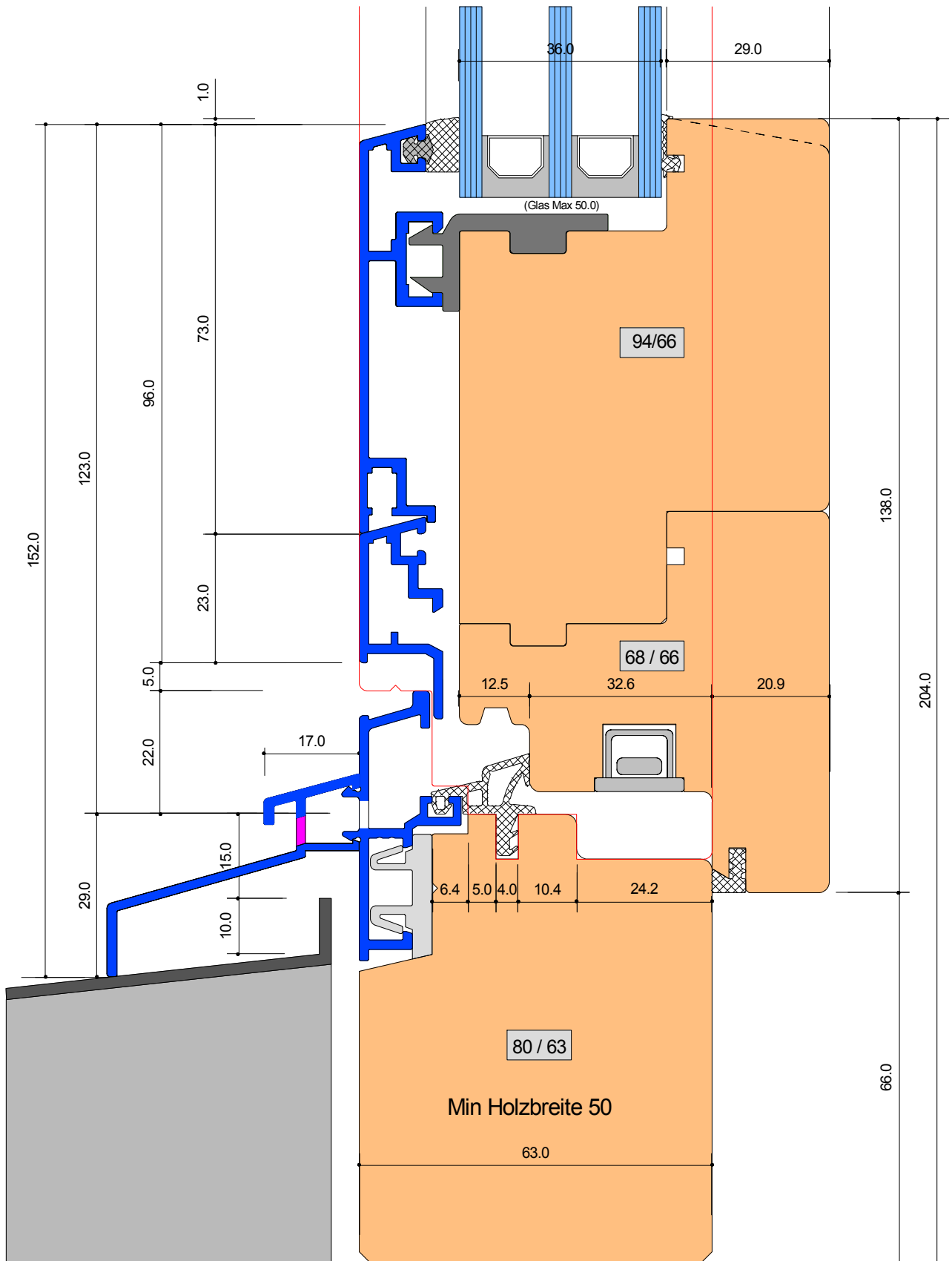

## SYSTEM: L-1 63-66

Anschluss unten BT 138 mm breit  
Wetterschenkel Typ RWS 045-013

Detail-Nr :	L-1	D=006
-------------	-----	-------



Von Euw Fenster AG  
Schoosstrasse 2  
6418 Rothenthurm

Tel 041 839 80 50  
Fax 041 839 80 60

mail info@voneuw.ch

Ersteller: Adi von Euw  
Datum: 16.06.14  
Revidiert: 11.10.19

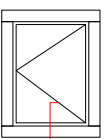



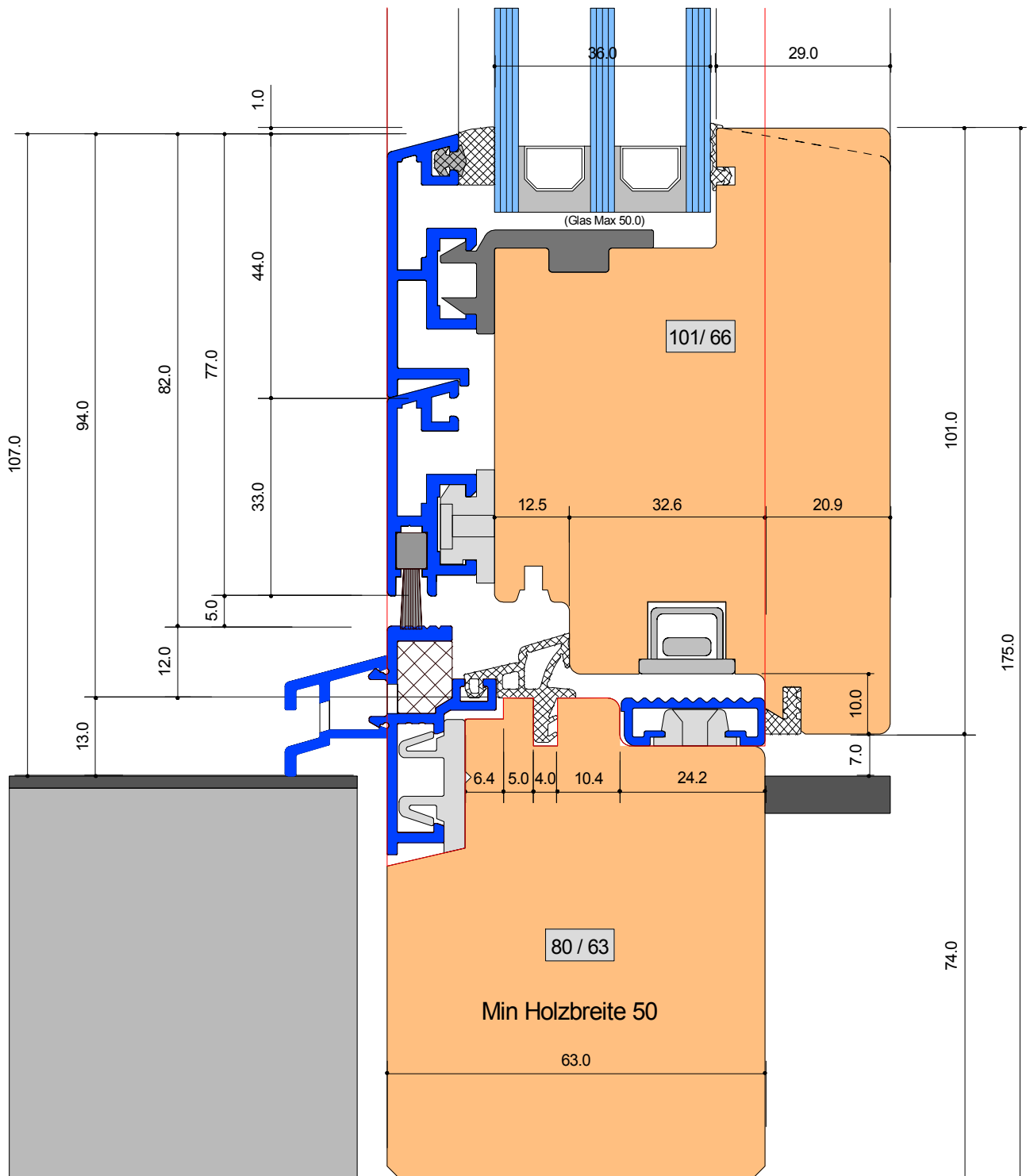

## SYSTEM: L-1 63-66

Anschluss unten Rollstuhlgängig BT 101(109)  
 Mit Flügelbreite 101 mm (-8.0)  
 Grundprofil M1-GR 038-18 Roll / Steckteil Variabel

Detail-Nr :	L-1	D=022
-------------	-----	-------



Von Euw Fenster AG  
 Schoosstrasse 2  
 6418 Rothenthurm

Tel 041 839 80 50  
 Fax 041 839 80 60  
 mail info@voneuw.ch

Ersteller: Adi von Euw  
 Datum: 16.06.14  
 Revidiert: 11.10.19

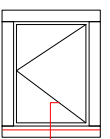

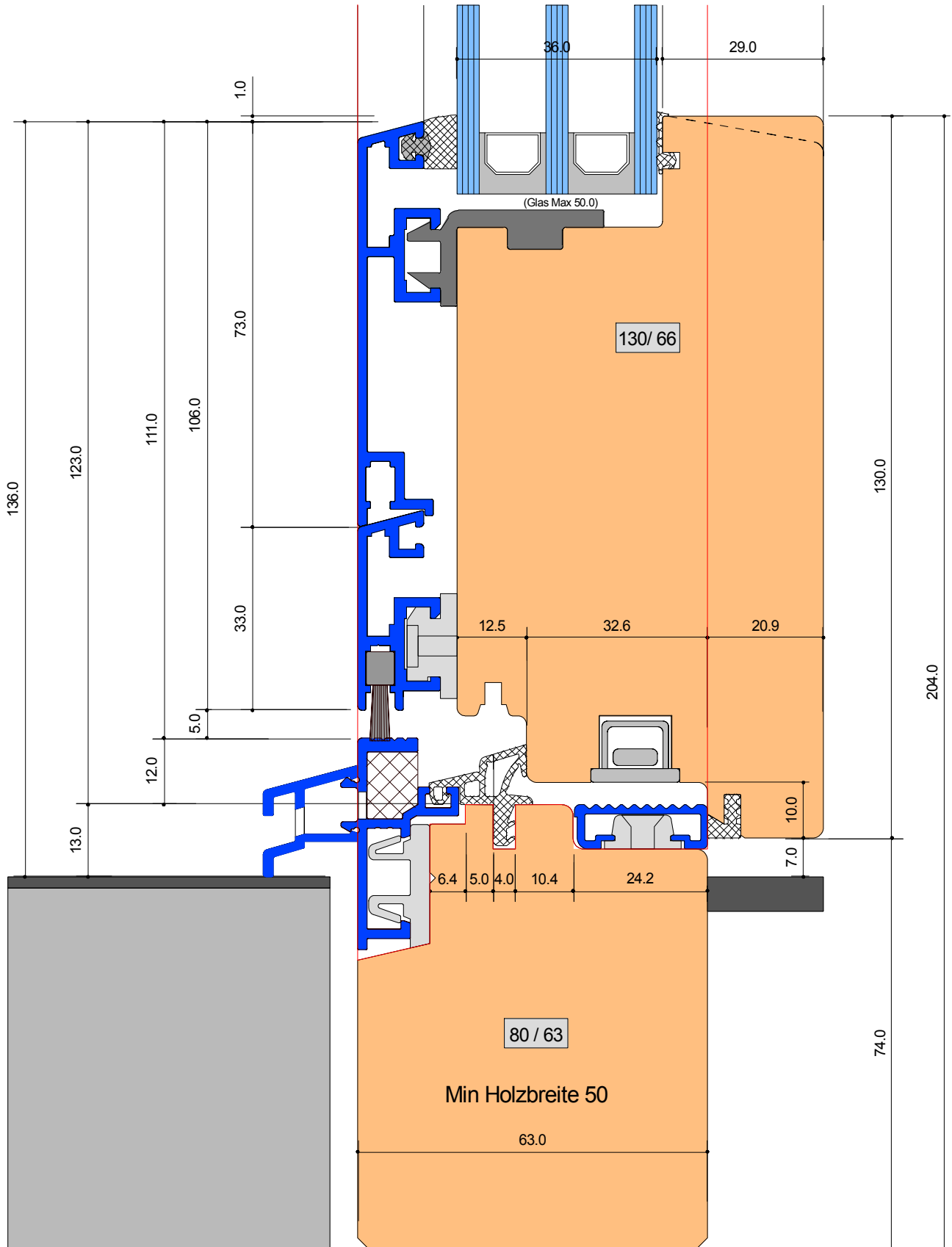

## SYSTEM: L-1 63-66

Anschluss unten Rollstuhlgängig BT 130(138)  
 Mit Flügelbreite 130 mm (-8.0)  
 Grundprofil M1-GR 038-18 Roll / Steckteil Variabel

Detail-Nr :	L-1	D=023
-------------	-----	-------



Von Euw Fenster AG  
 Schoosstrasse 2  
 6418 Rothenthurm

Tel 041 839 80 50  
 Fax 041 839 80 60  
 mail info@voneuw.ch

Ersteller: Adi von Euw  
 Datum: 16.06.14  
 Revidiert: 11.10.19

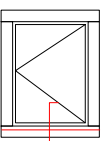



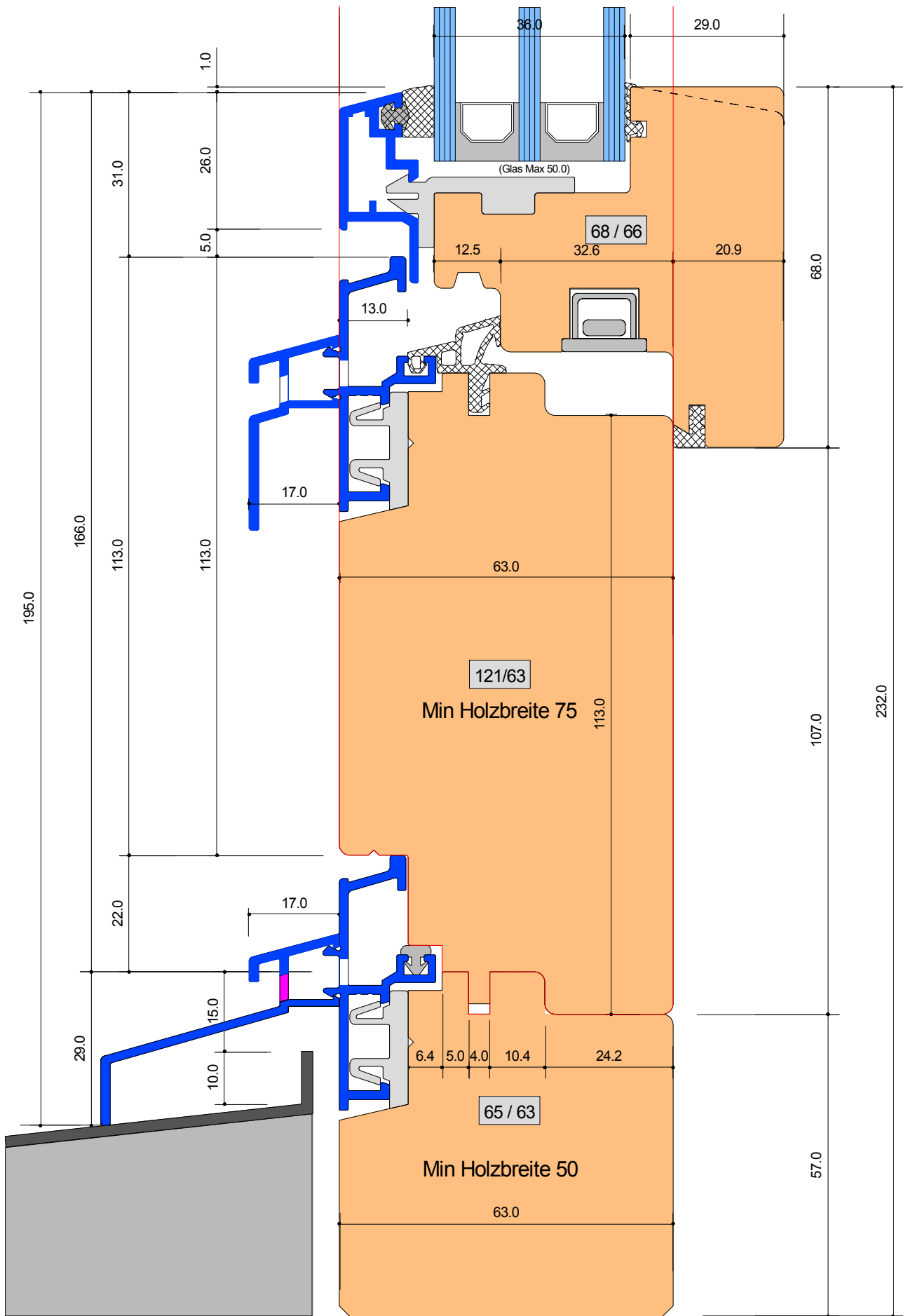

**SYSTEM: L-1 63-66**

Anschluss unten mit Einleimer  
Wetterschenkel Typ RWS 045-013

Detail-Nr :	L-1	D=031
-------------	-----	-------



Von Euw Fenster AG  
Schoosstrasse 2  
6418 Rothenthurm

Tel 041 839 80 50  
Fax 041 839 80 60  
mail info@voneuw.ch

Ersteller: Adi von Euw  
Datum: 16.06.14  
Revidiert:

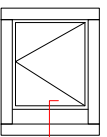

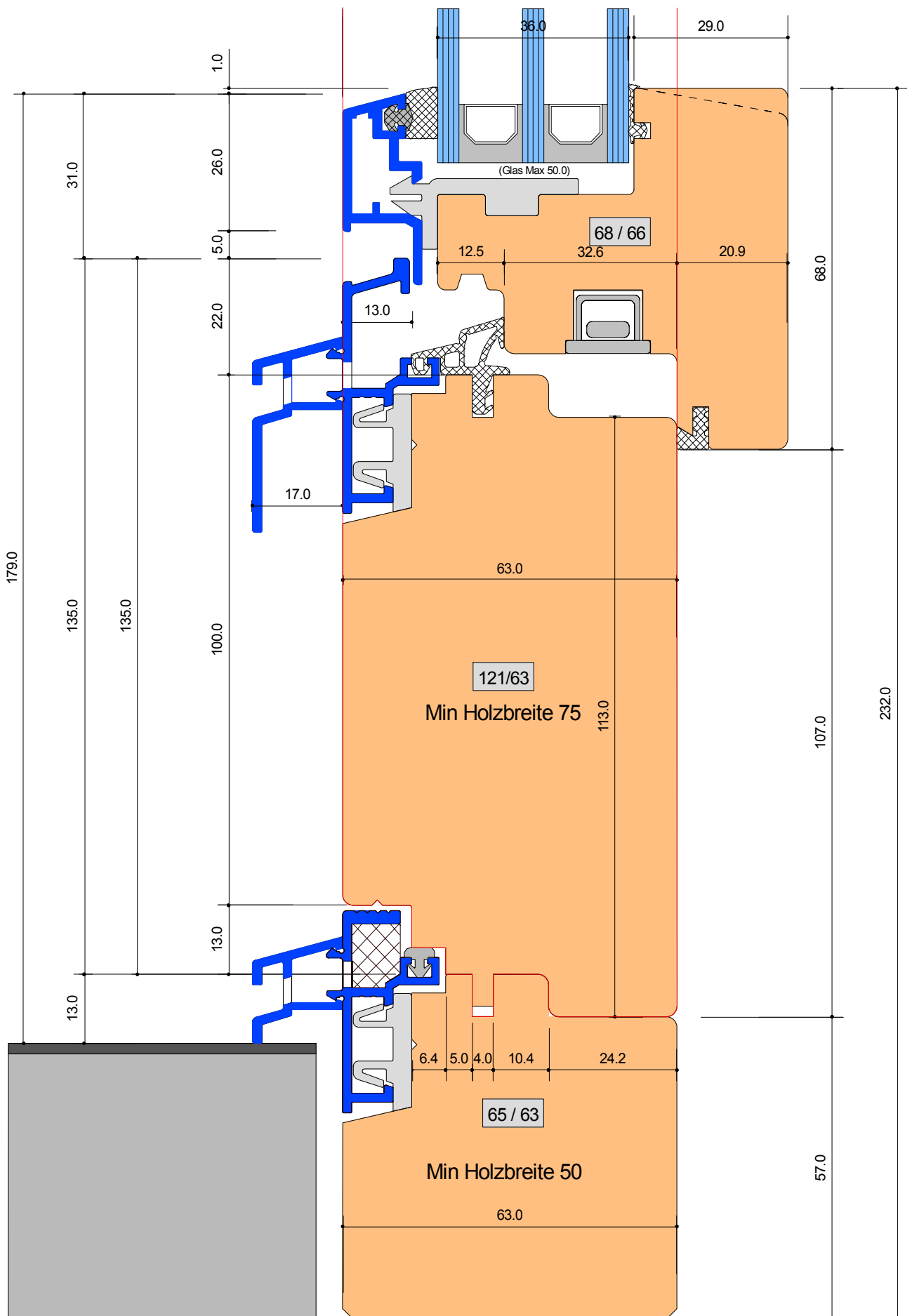

**SYSTEM: L-1 63-66**

Anschluss unten Rollstuhlgängig mit Einleimer

Grundprofil M1-GR 038-18 Roll / Steckteil Variabel

Detail-Nr :	L - 1	D=035
-------------	-------	-------



Von Euw Fenster AG  
Schoosstrasse 2  
6418 Rothenthurm

Tel 041 839 80 50  
Fax 041 839 80 60  
mail info@voneuw.ch

Ersteller: Adi von Euw  
Datum: 16.06.14  
Revidiert: 11.10.19

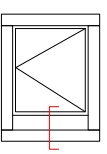

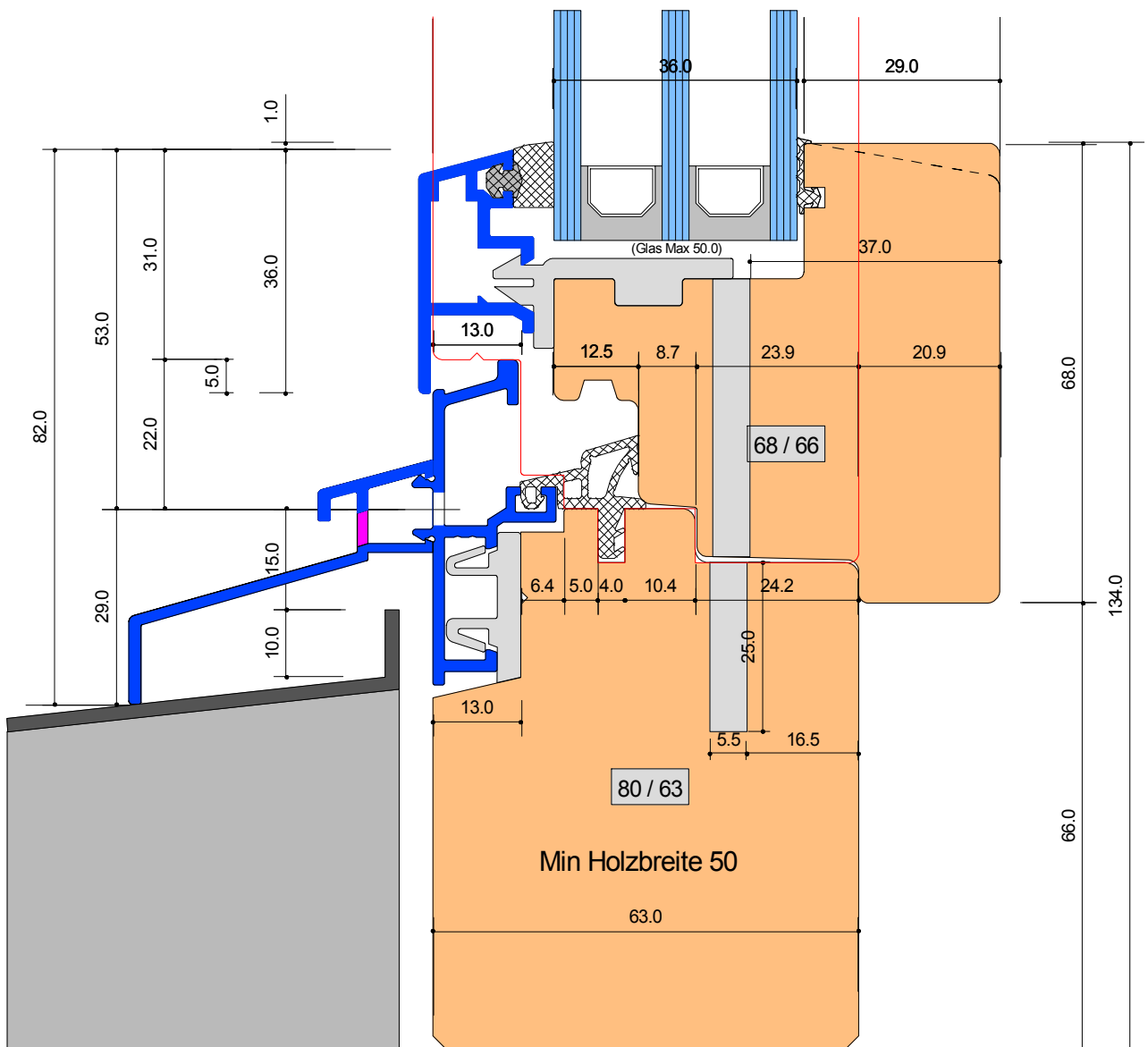

## SYSTEM: L-1 63-66

Anschluss unten mit Alu Fensterbank  
 Wetterschenkel Typ RWS 045-013  
 Fest verglast von aussen eingesetzt Flg 68 mm

Detail-Nr :	L - 1	D=041
-------------	-------	-------



Von Euw Fenster AG  
 Schoosstrasse 2  
 6418 Rothenthurm

Tel 041 839 80 50  
 Fax 041 839 80 60  
 mail info@voneuw.ch

Ersteller: Adi von Euw  
 Datum: 16.06.14  
 Revidiert:

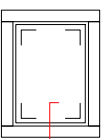



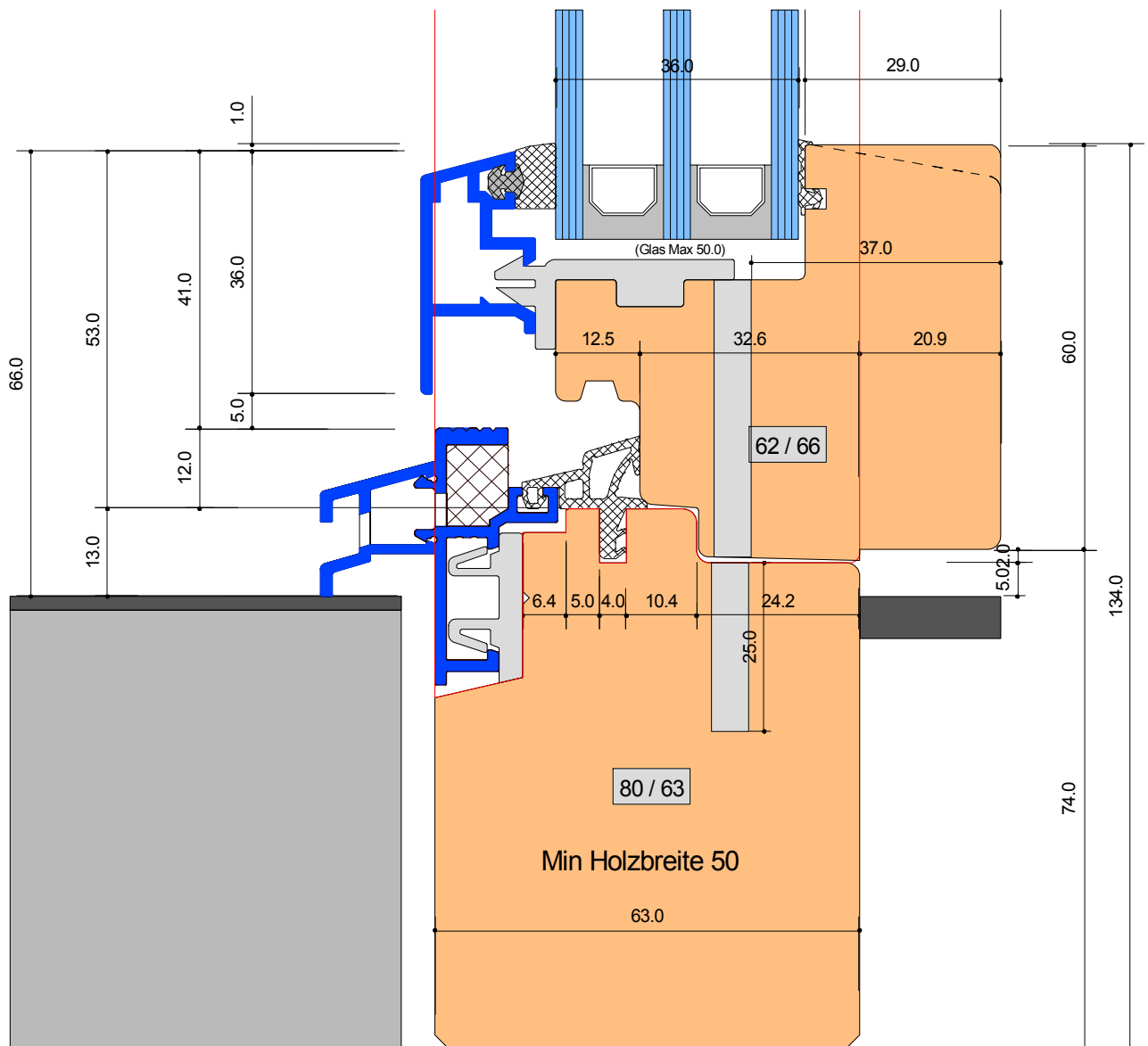

## SYSTEM: L-1 63-66

Anschluss unten Rollstuhlgängig  
 Mit Flügelbreite 62 mm(-6.0mm) Fest verg. v. aussen  
 Grundprofil M1-GR 038-18 Roll / Steckteil Variabel

Detail-Nr :	L - 1	D=045
-------------	-------	-------



Von Euw Fenster AG  
 Schoosstrasse 2  
 6418 Rothenthurm

Tel 041 839 80 50  
 Fax 041 839 80 60  
 mail info@voneuw.ch

Ersteller: Adi von Euw  
 Datum: 16.06.14  
 Revidiert: 11.10.19

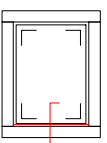

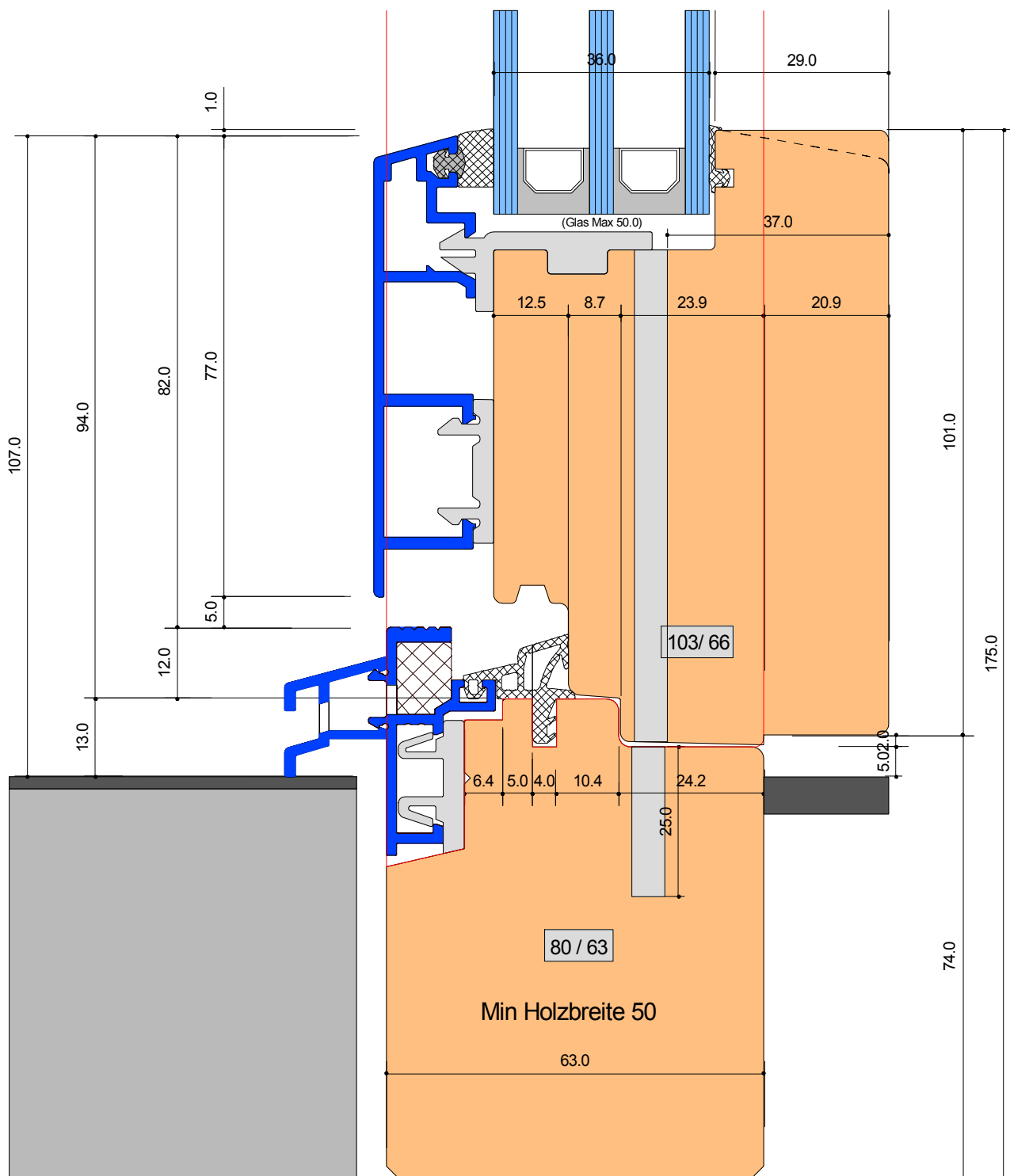

## SYSTEM: L-1 63-66

Anschluss unten Rollstuhlgängig  
 Mit Flügelbreite 103 (-6.0mm) Fest vergl. v. aussen  
 Grundprofil M1-GR 038-18 Roll / Steckteil Variabel

Detail-Nr :	L - 1	D=046
-------------	-------	-------



Von Euw Fenster AG  
 Schoosstrasse 2  
 6418 Rothenthurm

Tel 041 839 80 50  
 Fax 041 839 80 60  
 mail info@voneuw.ch

Ersteller: Adi von Euw  
 Datum: 16.06.14  
 Revidiert: 11.10.19

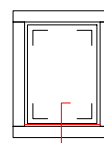

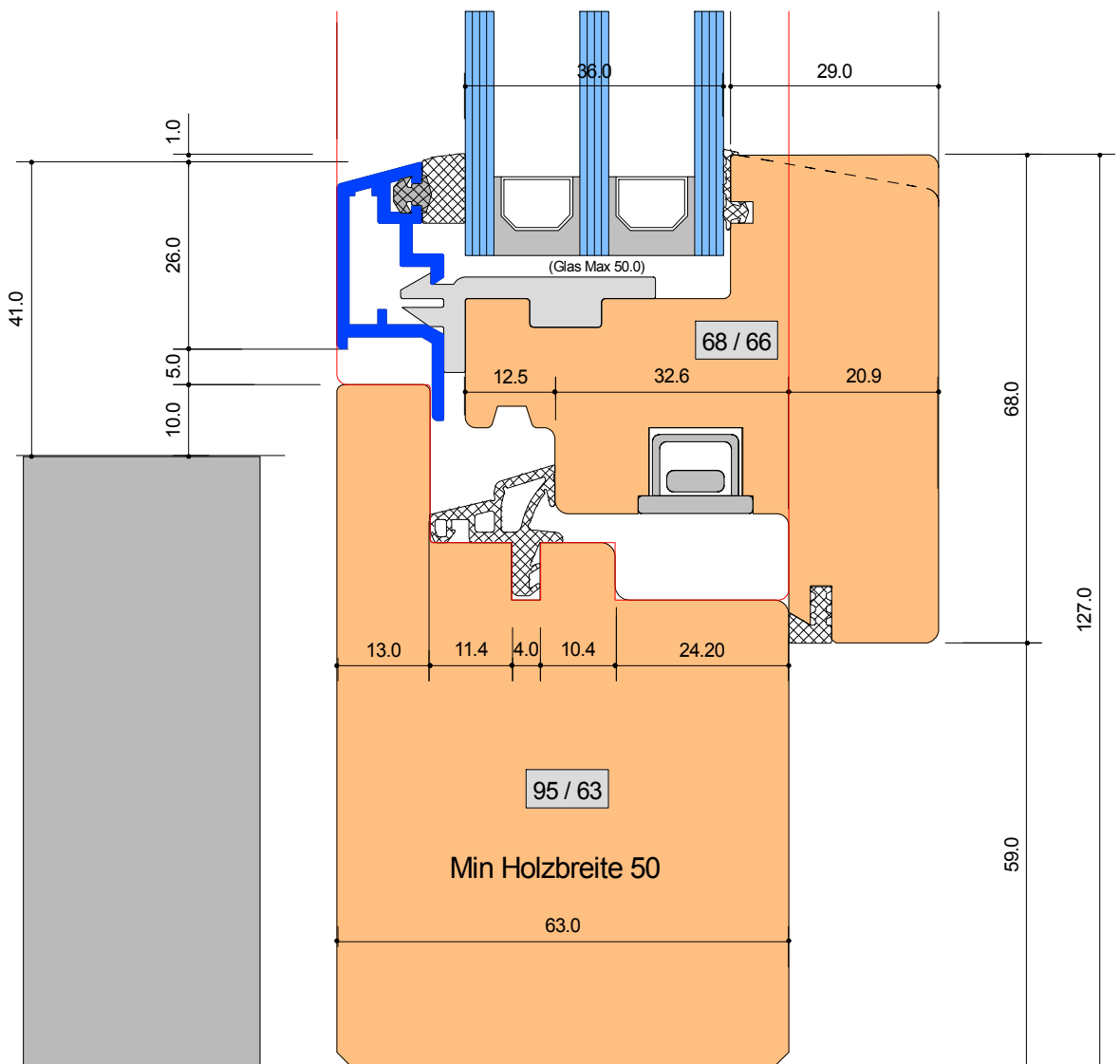

## SYSTEM: L-1 63-66

Anschluss seitlich Standart Flg 68

Detail-Nr :	L - 1	D=201
-------------	-------	-------

Ersteller: Adi von Euw  
 Datum: 10.03.14  
 Revidiert:



Von Euw Fenster AG  
 Schoosstrasse 2  
 6418 Rothenthurm

Tel 041 839 80 50  
 Fax 041 839 80 60  
 mail info@voneuw.ch

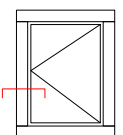

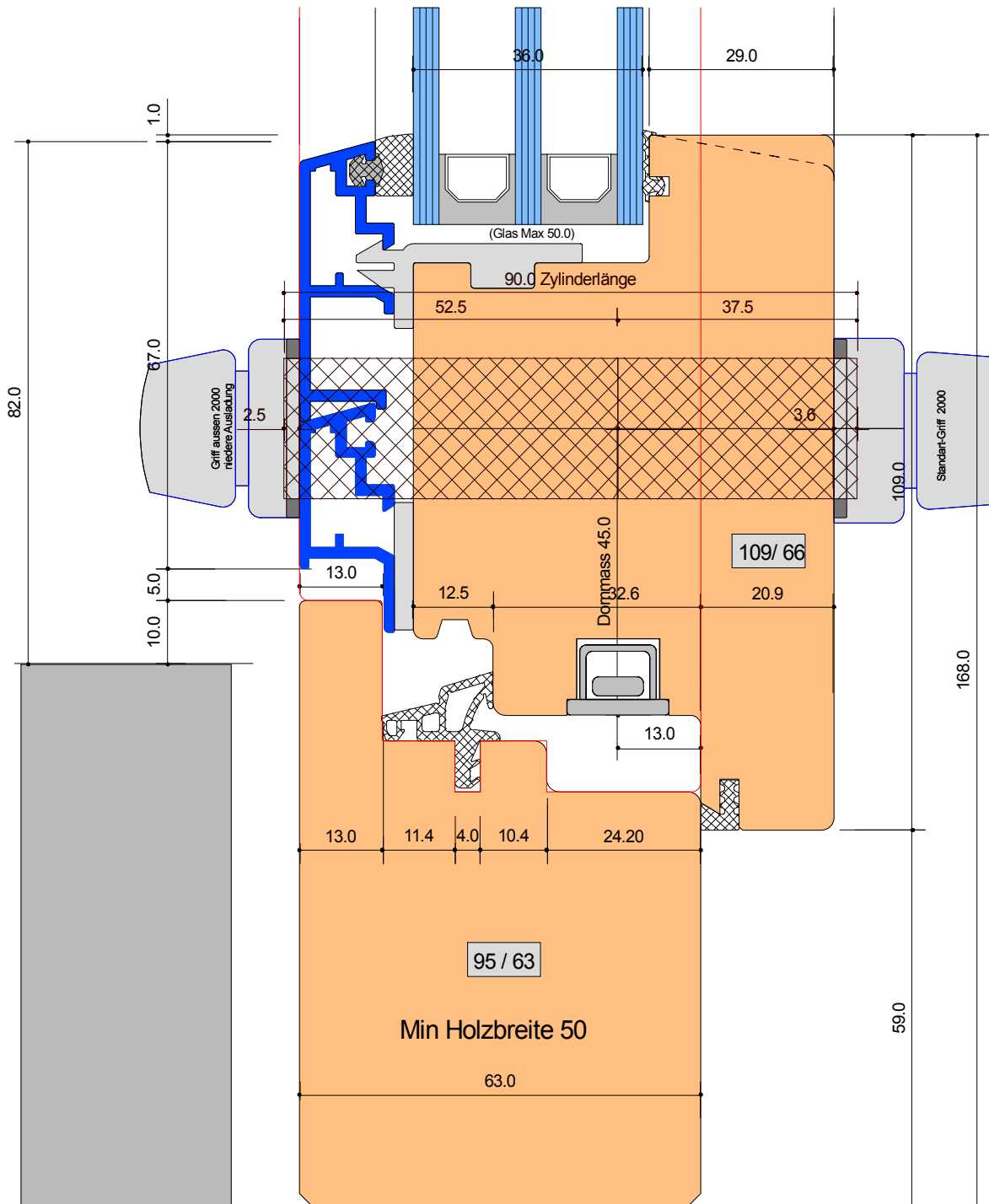

## SYSTEM: L-1 63-66

Anschluss seitlich Standard Fig 109 mm  
 Verschluss durchg. D=45.0 mm Griff m. Knopf/Schlüssel  
 Variante: Verschluss durchg. D=45.0 mm mit Zylinder

Detail-Nr :	L - 1	D=205
-------------	-------	-------



Von Euw Fenster AG  
 Schoosstrasse 2  
 6418 Rothenthurm

Tel 041 839 80 50  
 Fax 041 839 80 60  
 mail info@voneuw.ch

Ersteller: Adi von Euw  
 Datum: 16.06.16  
 Revidiert:

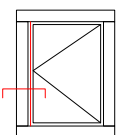



**Variante 1**  
 Schutzschild Glutz  
 ES1 5430S mit Zyl.  
 Schutzrosette (10-14 mm)

**Variante 1**  
 Innenschild Glutz  
 ES1 5435C.2 gerade

**Variante 2**  
 Rund-Schutzrosette Glutz  
 ES1 5330.2S-RS mit Schutz-  
 Einsatz (7-12 einwärts)

**Variante 2**  
 Rund-Rosette innen  
 5330.C mit Grundpl.

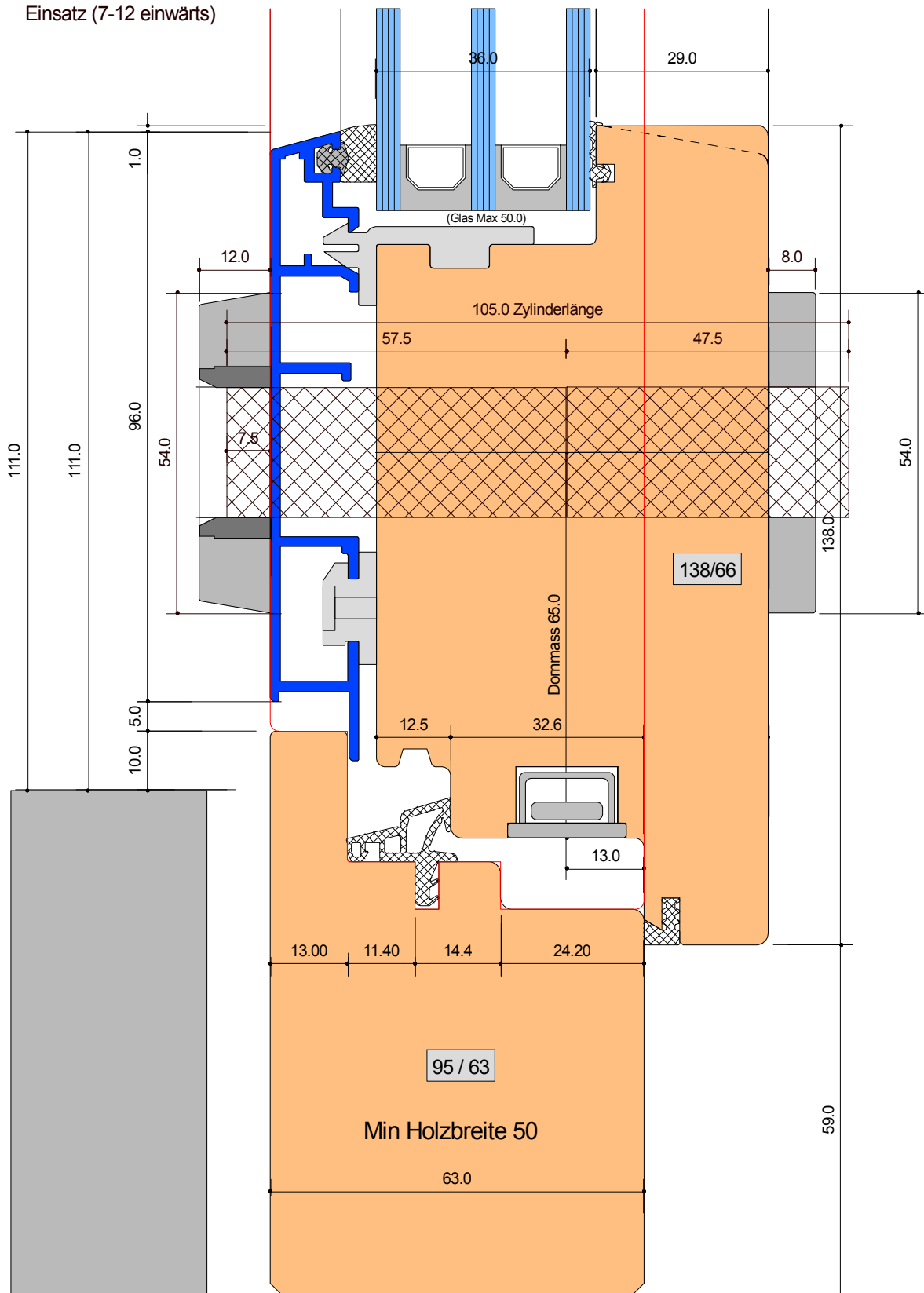

**SYSTEM: L-1 63-66**

Anschluss seitlich mit Flügel 138 mm  
 mit Haustürverschluss D=65 mm  
 mit Sicherheitslängsschild Glutz 5430S/5435C.2  
 mit Rund-Ros Glutz ES1 5330.2S-RS/5330C

Detail-Nr :	L - 1	D=210
-------------	-------	-------



Von Euw Fenster AG  
 Schoosstrasse 2  
 6418 Rothenthurm

Tel 041 839 80 50  
 Fax 041 839 80 60  
 mail info@voneuw.ch

Ersteller: Adi von Euw  
 Datum: 16.06.16  
 Revidiert:

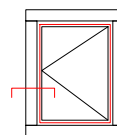

e

Glutz  
atte

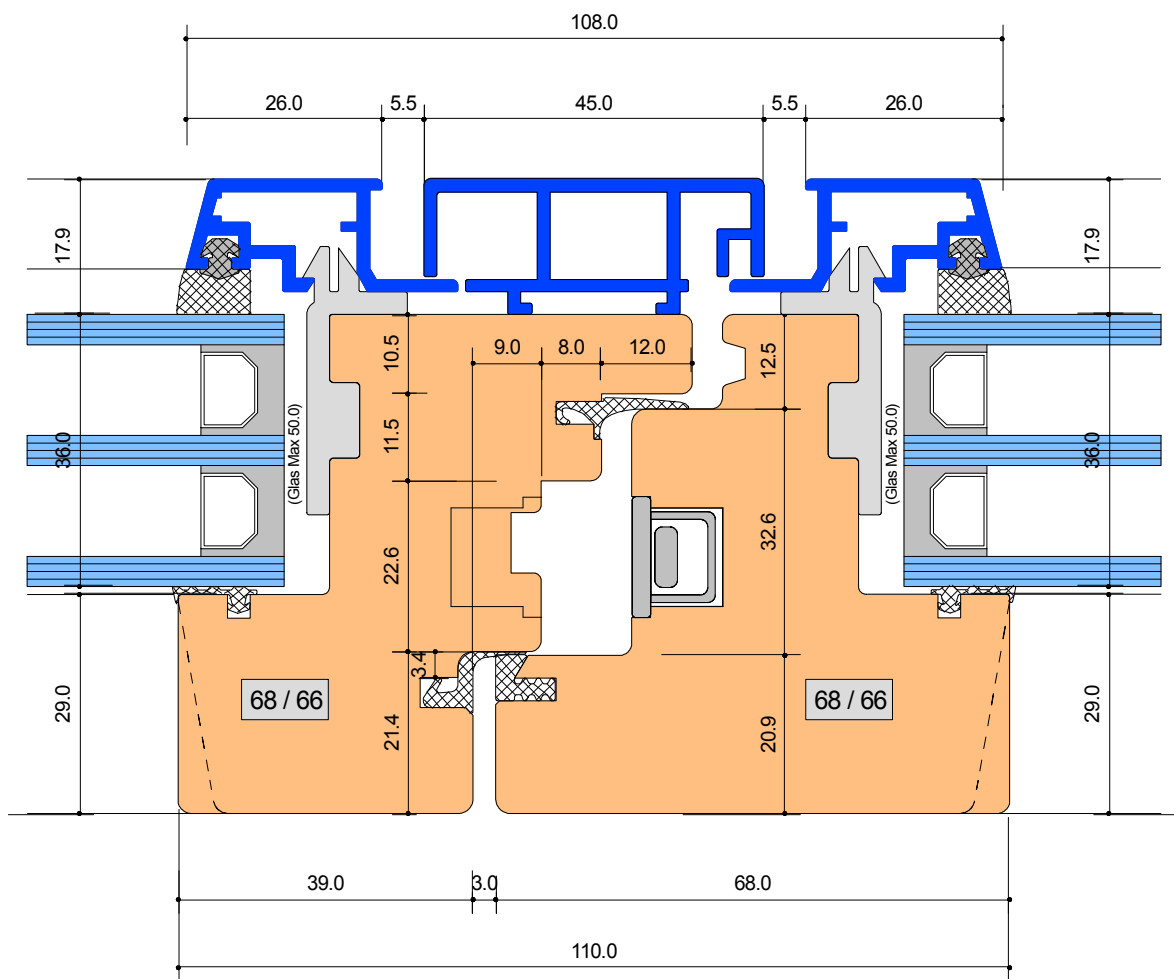

# SYSTEM: L-1 63-66

Anschluss seitlich Standart Flg 68

Detail-Nr :	L - 1	D=301
-------------	-------	-------



Von Euw Fenster AG  
 Schoosstrasse 2  
 6418 Rothenthurm

Tel 041 839 80 50  
 Fax 041 839 80 60  
 mail info@voneuw.ch

Ersteller: Adi von Euw  
 Datum: 16.06.14  
 Revidiert:

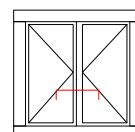

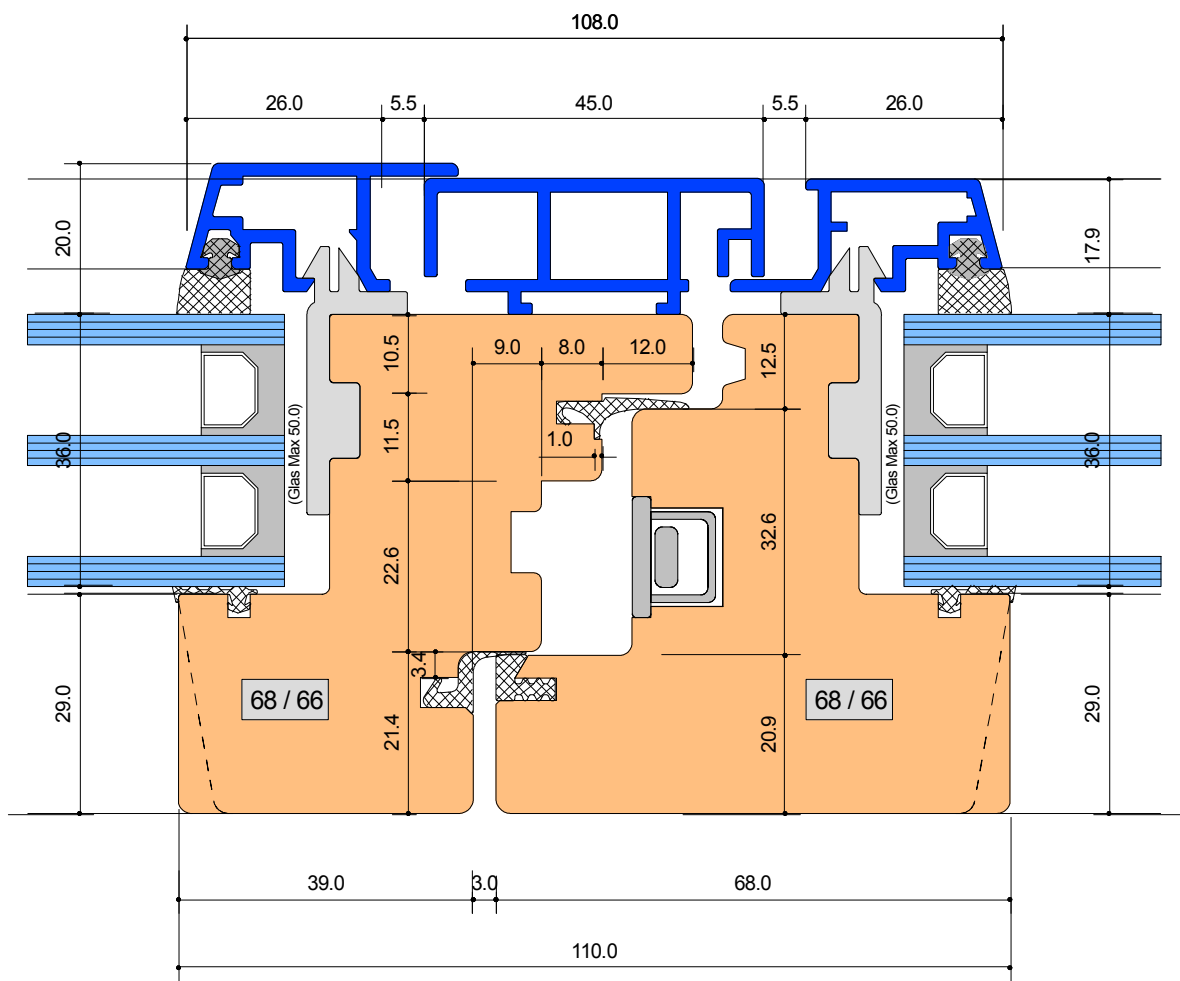

## SYSTEM: L-1 63-66

Mittelpartie einseitig mit fest vergl. Flg v. aussen

Detail-Nr :	L - 1	D=310
-------------	-------	-------



Von Euw Fenster AG  
Schoosstrasse 2  
6418 Rothenthurm

Tel 041 839 80 50  
Fax 041 839 80 60  
mail info@voneuw.ch

Ersteller: Adi von Euw  
Datum: 16.06.14  
Revidiert:

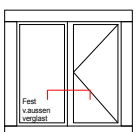

# Nicht freigegeben

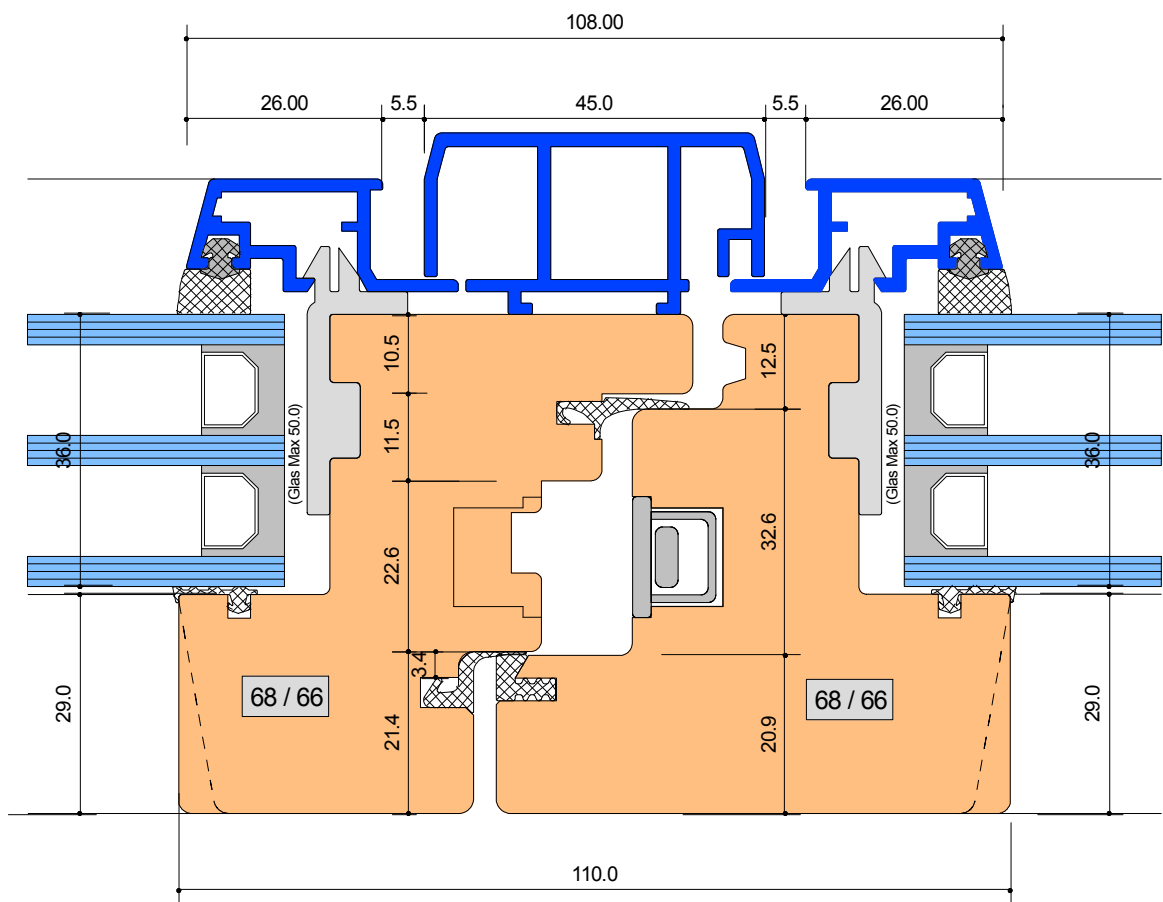

**SYSTEM: L-1 63-66**

Anschluss seitlich Standart Flg 68  
Mit Spezial-Schlagleiste

Detail-Nr :	L - 1	D=302
-------------	-------	-------



Von Euw Fenster AG  
Schoosstrasse 2  
6418 Rothenthurm

Tel 041 839 80 50  
Fax 041 839 80 60  
mail info@voneuw.ch

Ersteller: Adi von Euw  
Datum: 16.06.14  
Revidiert:

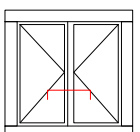

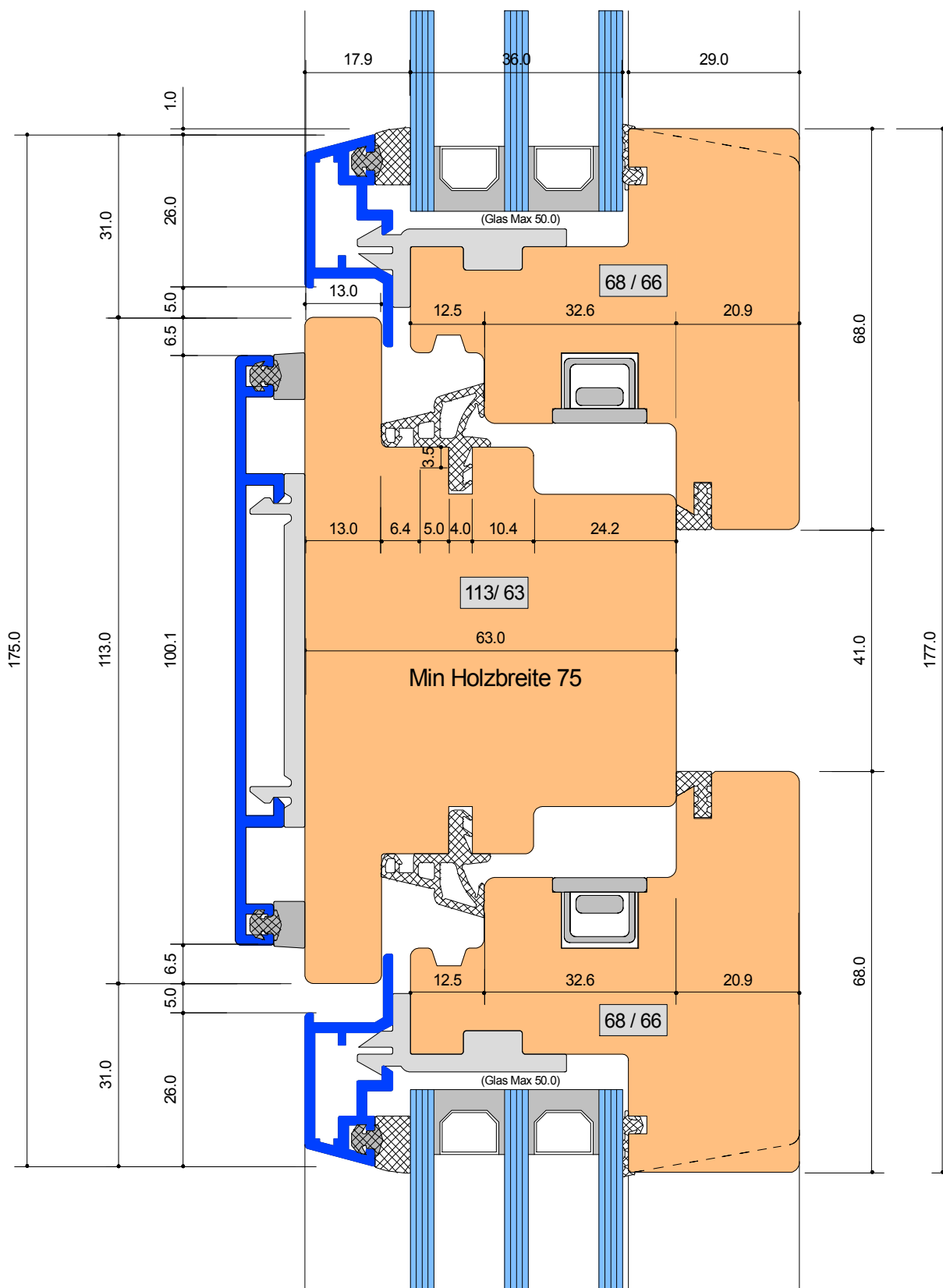

## SYSTEM: L-1 63-66

Setzholz 113 mm  
 Alu Klemmprofil 100 mm optional

Detail-Nr :	L - 1	D=401
-------------	-------	-------

Ersteller: Adi von Euw  
 Datum: 16.06.14  
 Revidiert:



Von Euw Fenster AG  
 Schoosstrasse 2  
 6418 Rothenthurm

Tel 041 839 80 50  
 Fax 041 839 80 60  
 mail info@voneuw.ch

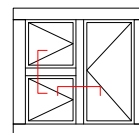

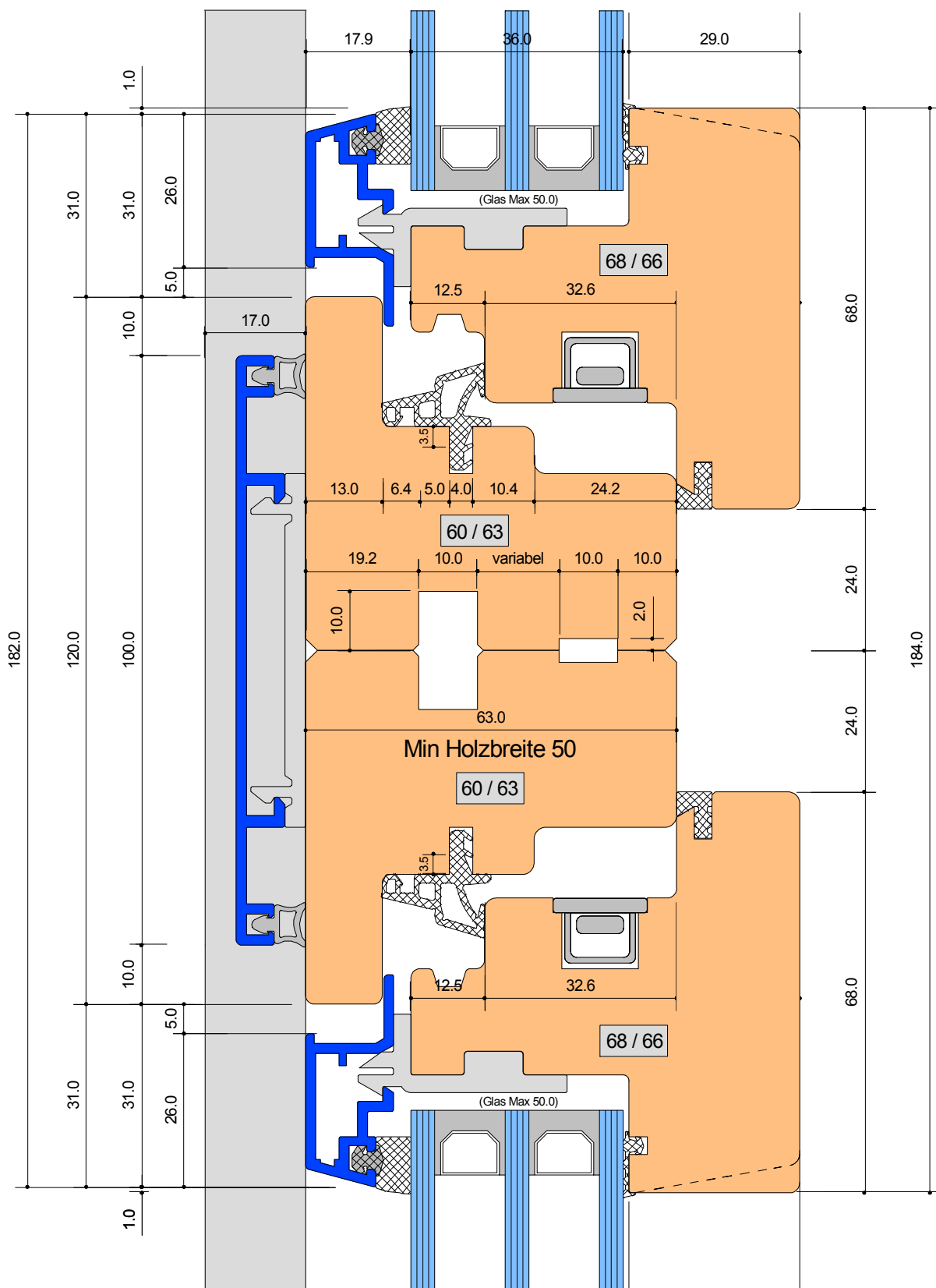

## SYSTEM: L-1 63-66

Kombinationszusammenbau mit Nut + Feder

Detail-Nr :	L - 1	D=405
-------------	-------	-------

Ersteller: Adi von Euw  
 Datum: 16.06.14  
 Revidiert:



Von Euw Fenster AG  
 Schoosstrasse 2  
 6418 Rothenthurm

Tel 041 839 80 50  
 Fax 041 839 80 60  
 mail info@voneuw.ch

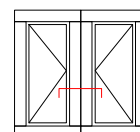

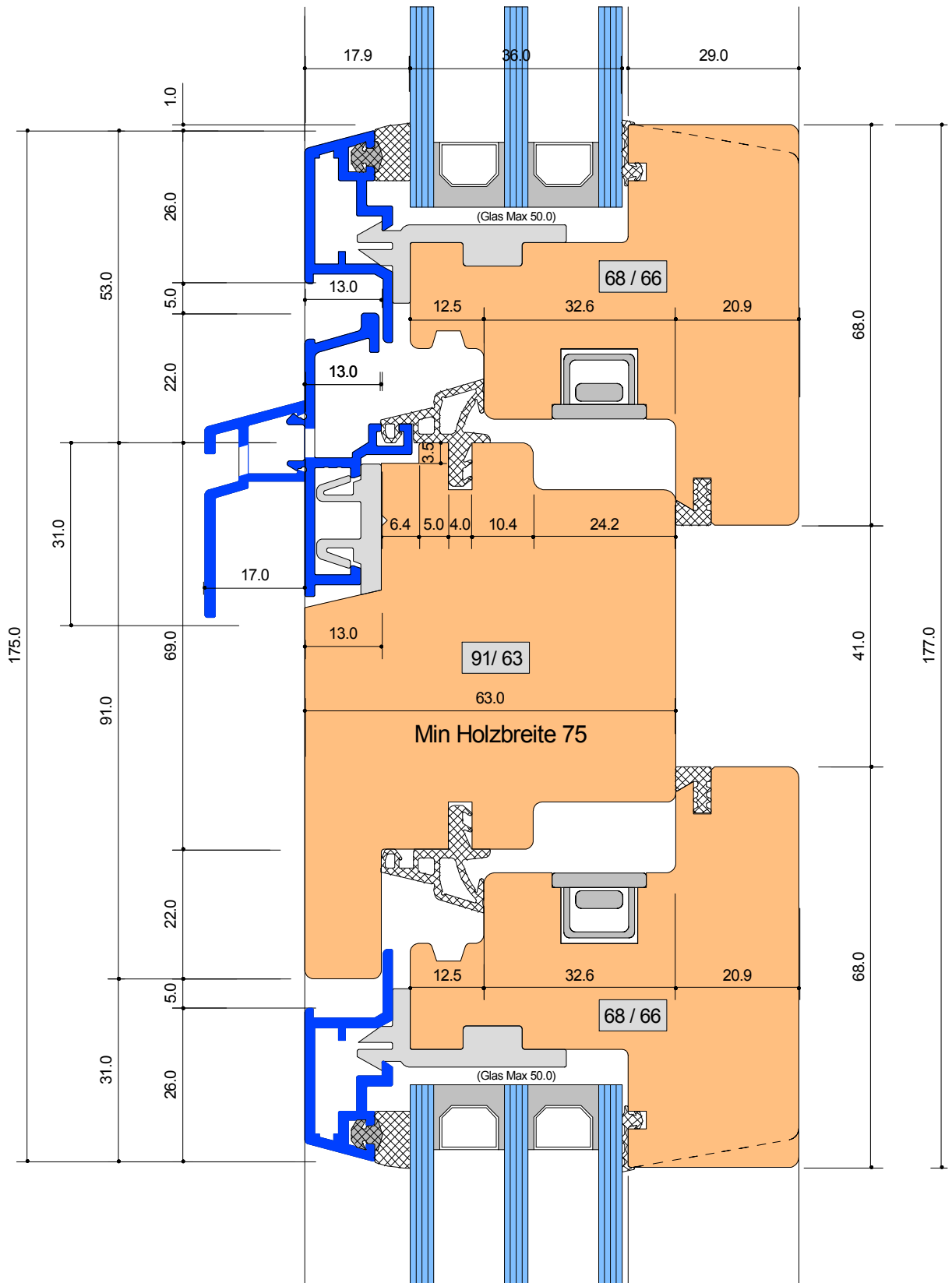

**SYSTEM: L-1 63-66**

Kämpfer

Detail-Nr :	L - 1	D=501
-------------	-------	-------

Ersteller: Adi von Euw  
 Datum: 16.06.14  
 Revidiert:



Von Euw Fenster AG  
 Schoosstrasse 2  
 6418 Rothenthurm

Tel 041 839 80 50  
 Fax 041 839 80 60  
 mail info@voneuw.ch

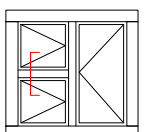

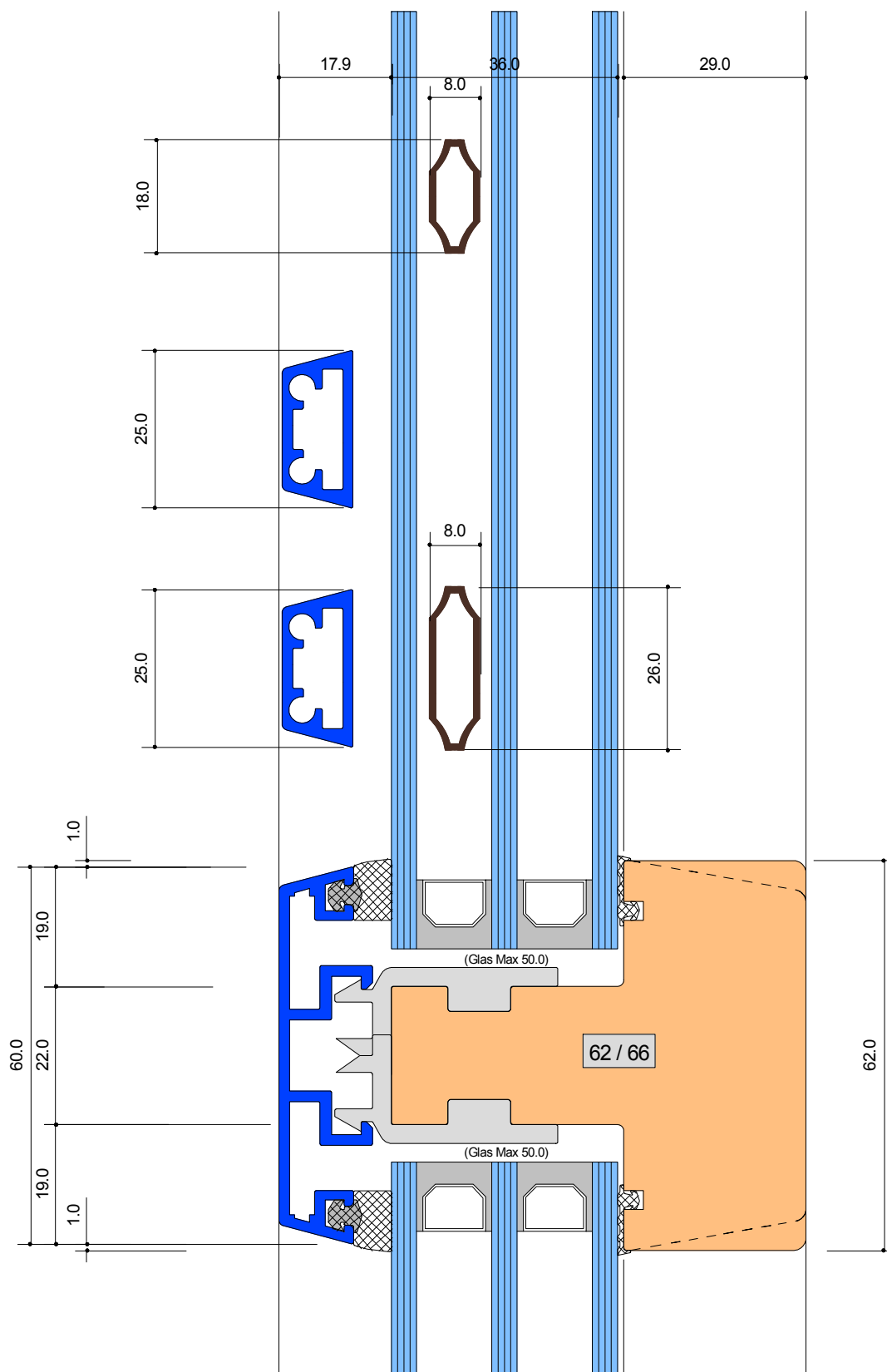

## SYSTEM: L-1 63-66

Sprossen glastrennend 62 mm Alu 60 mm  
 Vorgesetzte Alu-Spr. 25 mm +Zw.Glas Sprosse 26 mm  
 Vorgesetzte Alu-Spr. 25 mm  
 Zwischenglas -Sprosse 18 mm

Detail-Nr :	L -1	D=601
-------------	------	-------



Von Euw Fenster AG  
 Schoosstrasse 2  
 6418 Rothenthurm

Tel 041 839 80 50  
 Fax 041 839 80 60  
 mail info@voneuw.ch

Ersteller: Adi von Euw  
 Datum: 16.06.14  
 Revidiert:

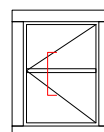



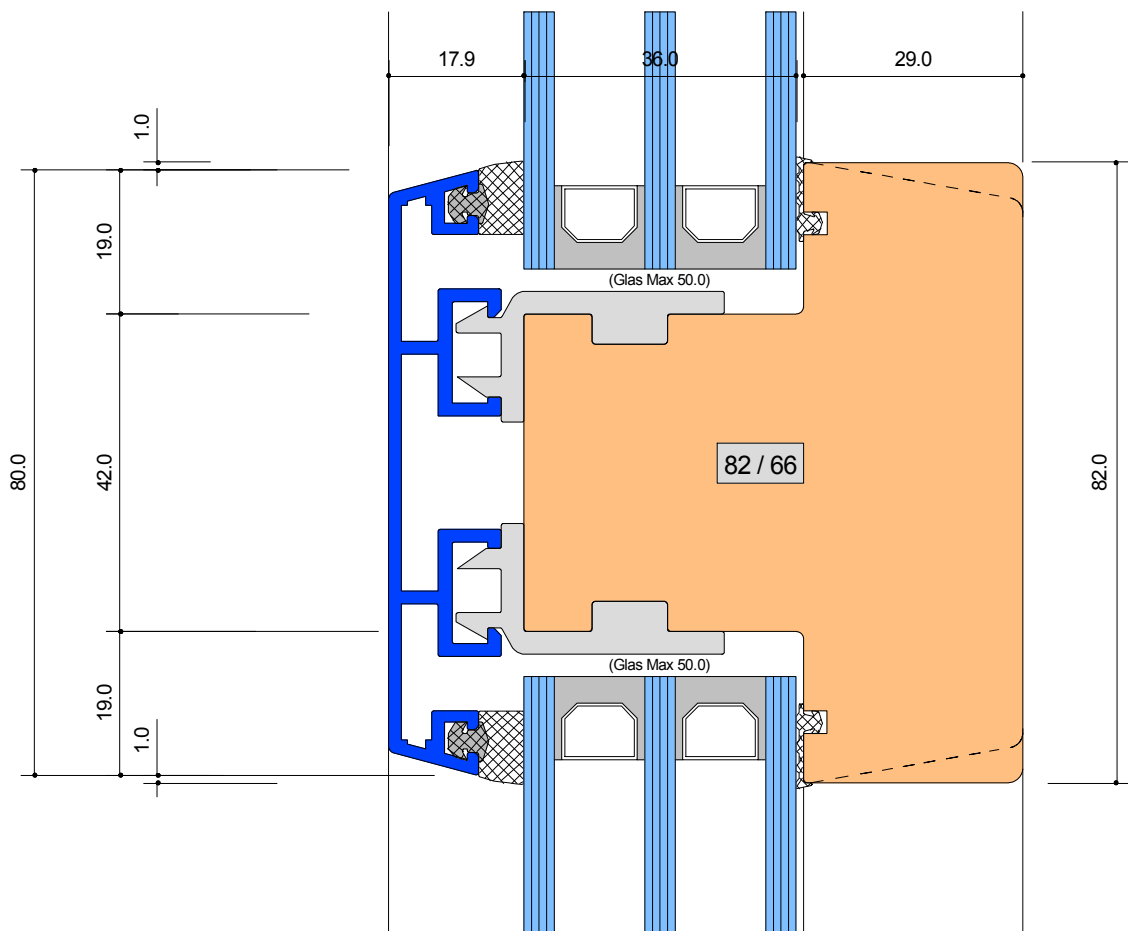

## SYSTEM: L-1 63-66

Sprossen glastrennend 80 mm

Detail-Nr :	L -1	D=602
-------------	------	-------



Von Euw Fenster AG  
Schoosstrasse 2  
6418 Rothenthurm

Tel 041 839 80 50  
Fax 041 839 80 60  
mail info@voneuw.ch

Ersteller: Adi von Euw  
Datum: 16.06.14  
Revidiert:

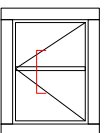

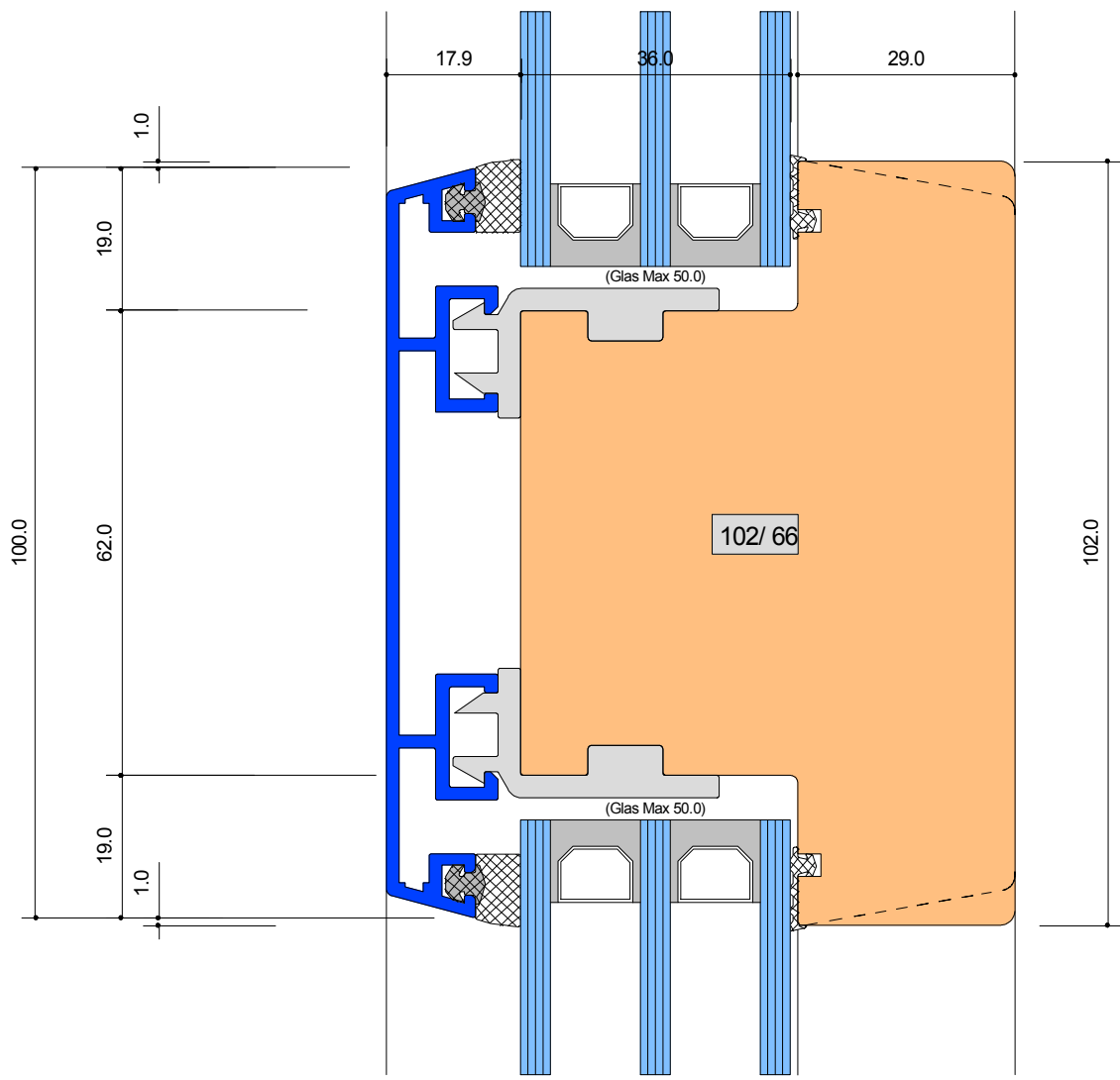

**SYSTEM: L-1 63-66**

Sprossen glastrennend 100 mm

Detail-Nr :	L -1	D=603
-------------	------	-------

Ersteller: Adi von Euw  
 Datum: 16.06.14  
 Revidiert:



Von Euw Fenster AG  
 Schoosstrasse 2  
 6418 Rothenthurm

Tel 041 839 80 50  
 Fax 041 839 80 60  
 mail info@voneuw.ch

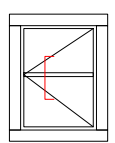

N69202 0.353 g/m1  
 X1-ST 045-008 (roh+eloxiert)  
 Fräsung 30.0 x 5.0 mm  
 Abstand 125/25x250/125

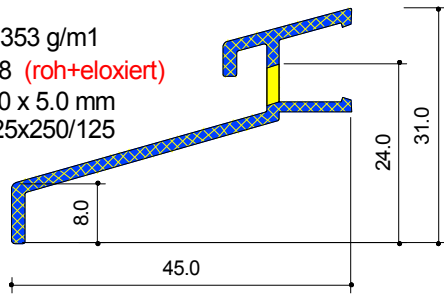

N74777 0.378 g/m1  
 X1-ST 045-013 (roh+eloxiert)  
 Fräsung 30.0 x 5.0 mm  
 Abstand 125/25x250/125

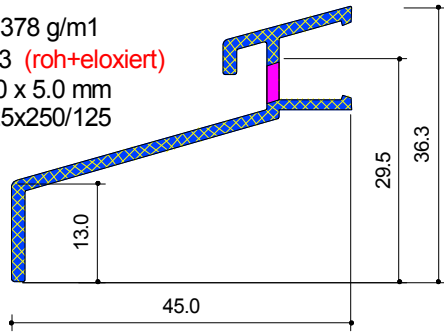

N70586 0.445 g/m1  
 X1-ST 065-008 (roh+eloxiert)  
 Fräsung 30.0 x 5.0 mm  
 Abstand 125/25x250/125

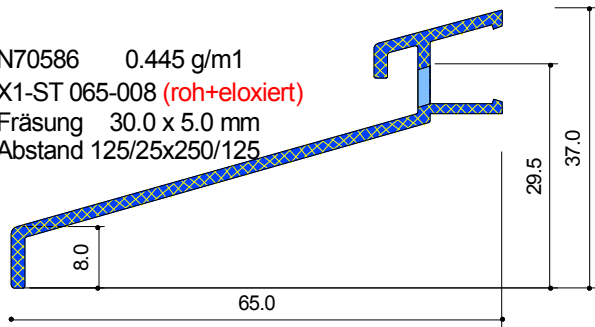

N74260 0.561 g/m1  
 X1-ST 065-030 (eloxiert)  
 Fräsung 30.0 x 5.0 mm  
 Abstand 125/25x250/125

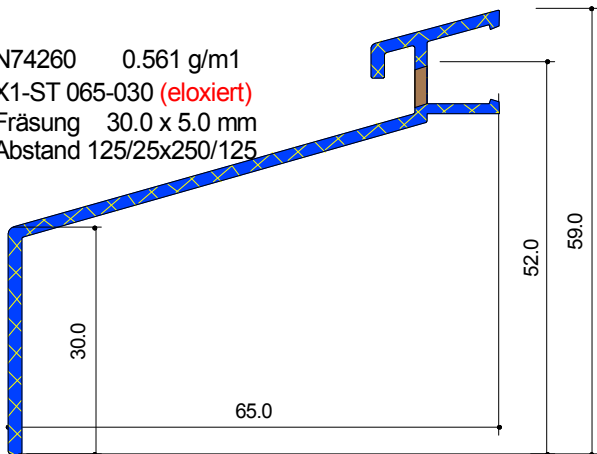

N70584 0.295 g/m1  
 X1-ST 017-021 (eloxiert)  
 Fräsung 30.0 x 5.0 mm  
 Abstand 125/25x250/125

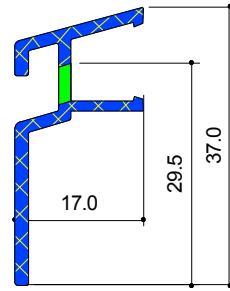

N70585 0.393 g/m1  
 X1-ST 017-041 (eloxiert)  
 Fräsung 30.0 x 5.0 mm  
 Abstand 125/25x250/125

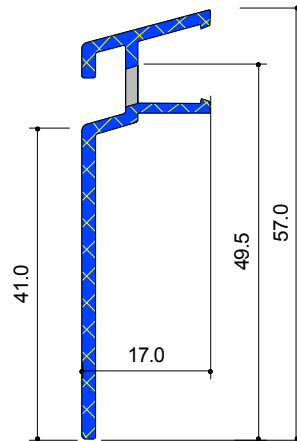

N74261 0.620 g/m1  
 X1-ST 017-084 (eloxiert)  
 Fräsung 30.0 x 5.0 mm  
 Abstand 125/25x250/125

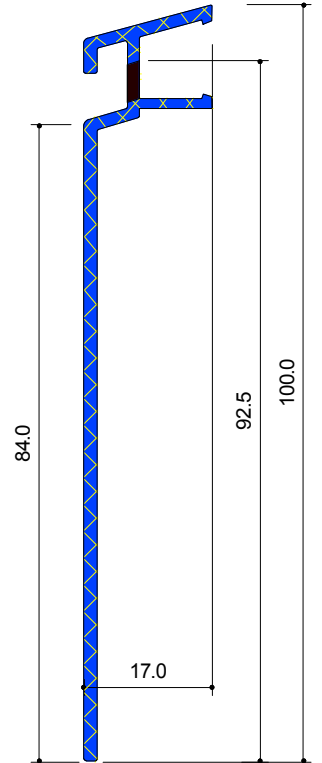

L49108 0.450 g/m1  
 M1-GR 038-18 Roll (roh)  
 Fräsung 30.0 x 5.0 mm  
 Abstand 50/32x200/50

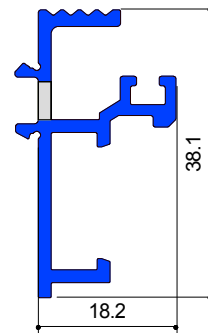

SYSTEM: \*H, L, M, R\*

Steckteil-Profilübersicht



Detail-Nr : A-1 D=100



Von Euw Fenster AG  
 Schoosstrasse 2  
 6418 Rothenthurm

Tel 041 839 80 50  
 Fax 041 839 80 60  
 mail info@voneuw.ch

Ersteller: Adi von Euw  
 Datum: 11.10.19

-  Alu \*roh\* (Lager)
-  Alu \*farblos elox.\* (Lager)
-  Alu \*Roh + farblos elox.\* (Lager)