

Von Euw



Fenster AG  
SWISS QUALITY WINDOWS

# Holzfenster

System : H-2 67/78 „eco class“

## Vermasste Standard-Details

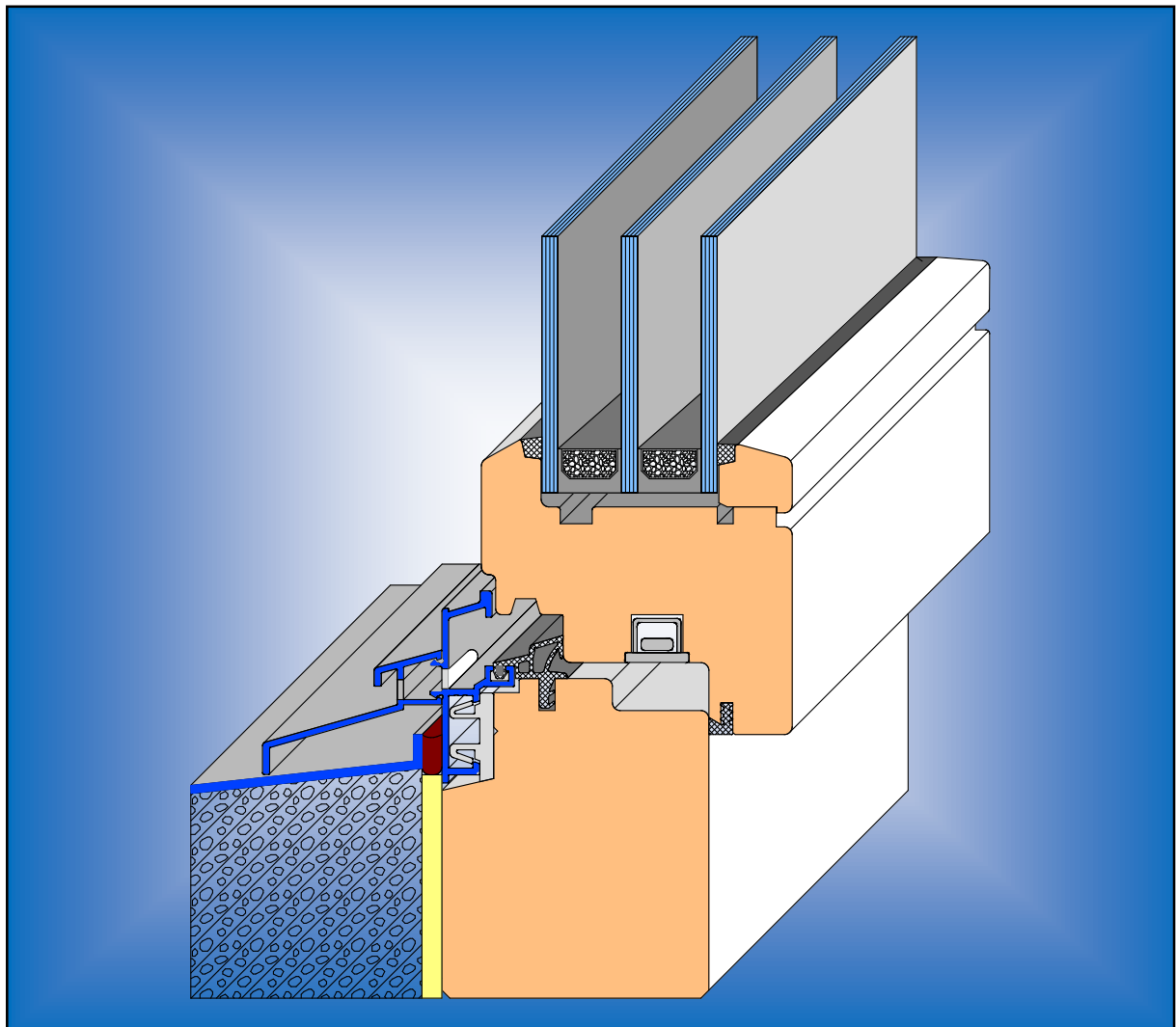

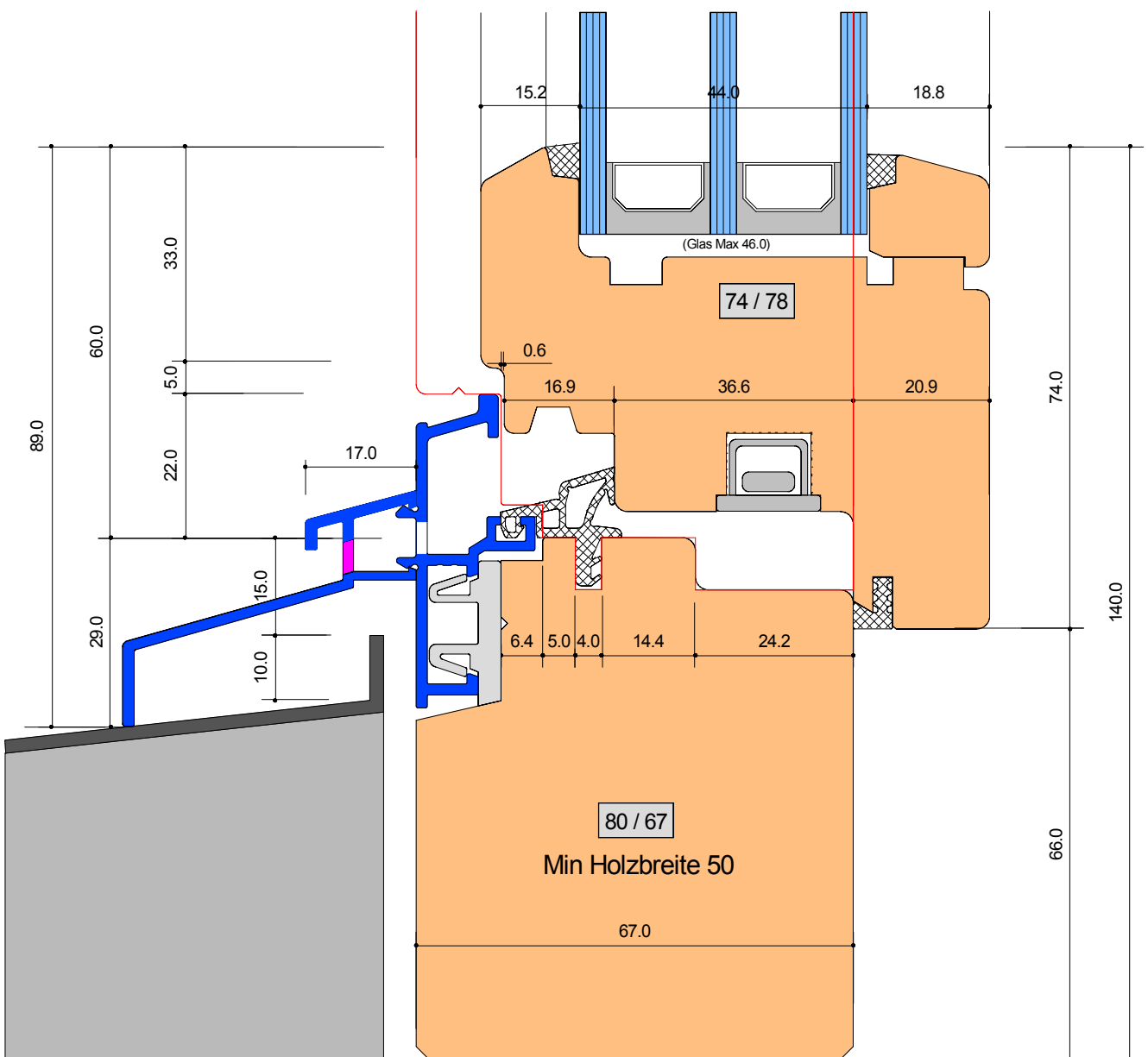

# SYSTEM: H-2 67-78

Anschluss unten mit Alu Fensterbank  
Wetterschenkel Typ RWS 045-013

Detail-Nr :	H - 2	D=001
-------------	-------	-------



Von Euw Fenster AG  
Schoosstrasse 2  
6418 Rothenthurm

Tel 041 839 80 50  
Fax 041 839 80 60  
mail info@voneuw.ch

Ersteller: Adi von Euw  
Datum: 27.10.15  
Revidiert:

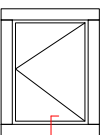

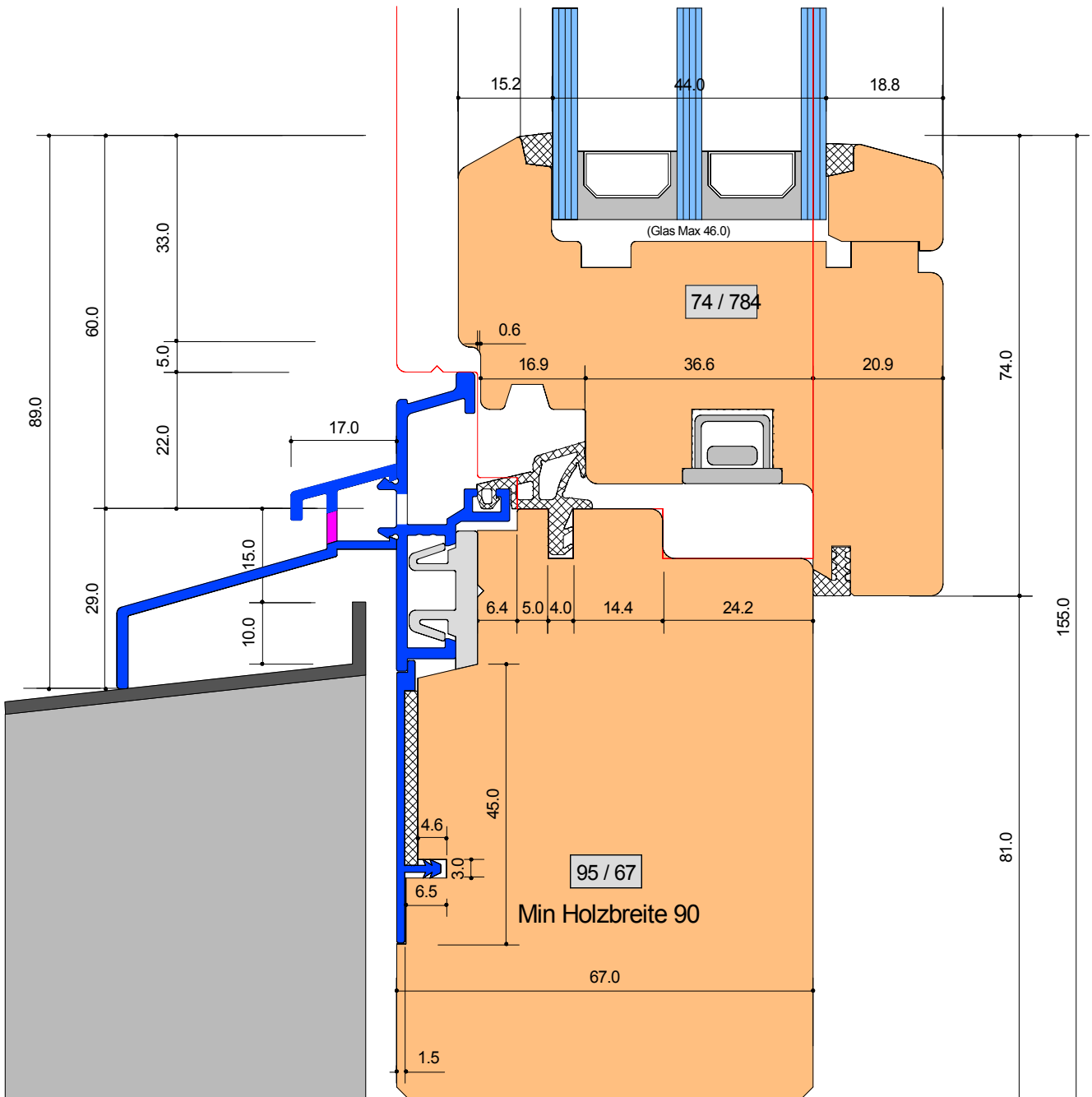

## SYSTEM: H-2 67-78

Anschluss unten mit Alu Fensterbank  
 Wetterschenkel Typ RWS 045-013  
 mit Zusatzprofil für Abklebung bauseits

Detail-Nr :	H - 2	D=001Z
-------------	-------	--------



Von Euw Fenster AG  
 Schoosstrasse 2  
 6418 Rothenthurm

Tel 041 839 80 50  
 Fax 041 839 80 60  
 mail info@voneuw.ch

Ersteller: Adi von Euw  
 Datum: 27.10.15  
 Revidiert:

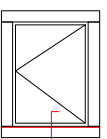

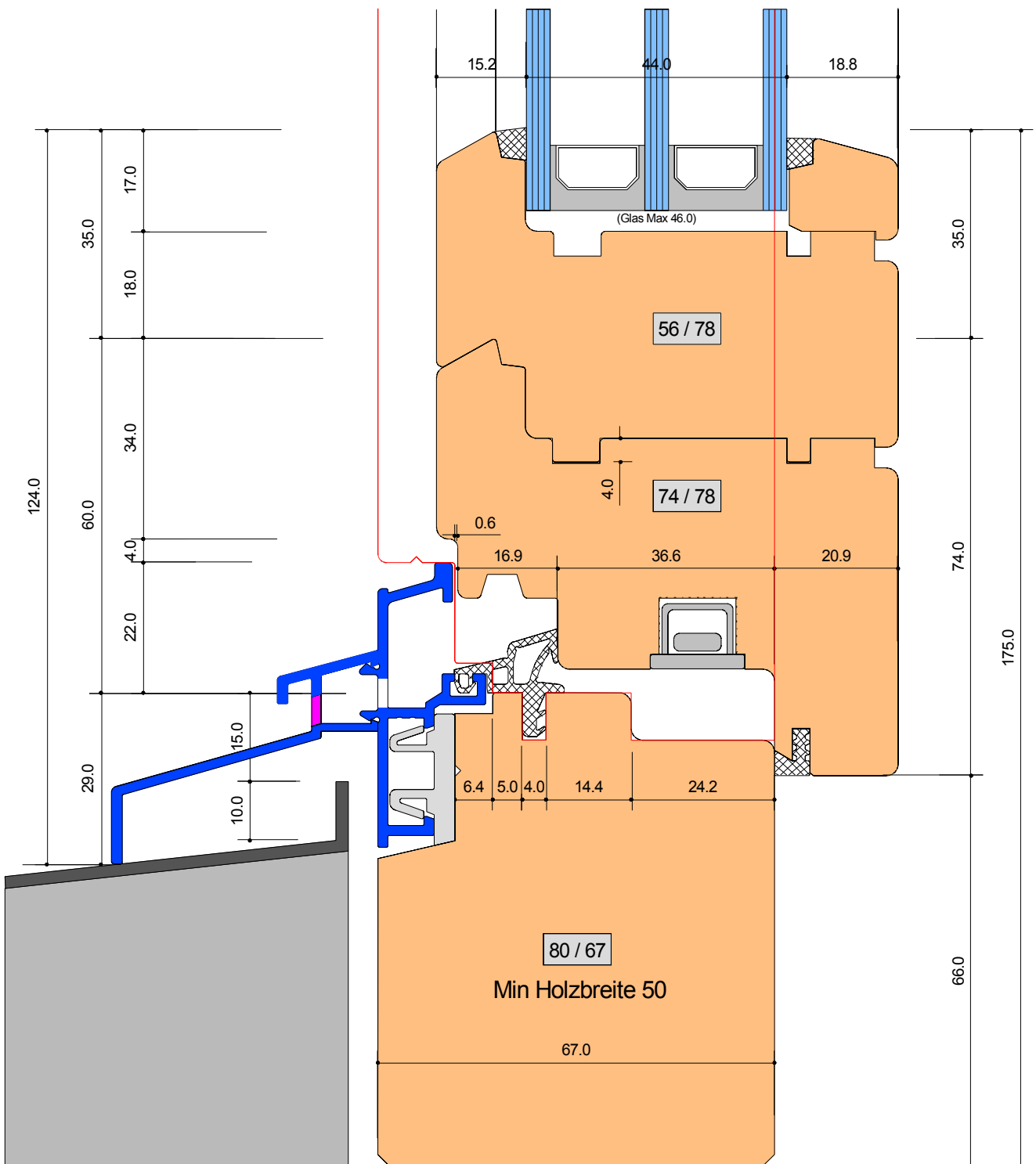

# SYSTEM: H-2 67-78

Anschluss unten BT mit Einl 109 mm breit  
Wetterschenkel Typ RWS 045-013

Detail-Nr :	H - 2	D=005
-------------	-------	-------



Von Euw Fenster AG  
Schoosstrasse 2  
6418 Rothenthum

Tel 041 839 80 50  
Fax 041 839 80 60  
mail info@voneuw.ch

Ersteller: Adi von Euw  
Datum: 27.10.15  
Revidiert:

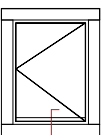

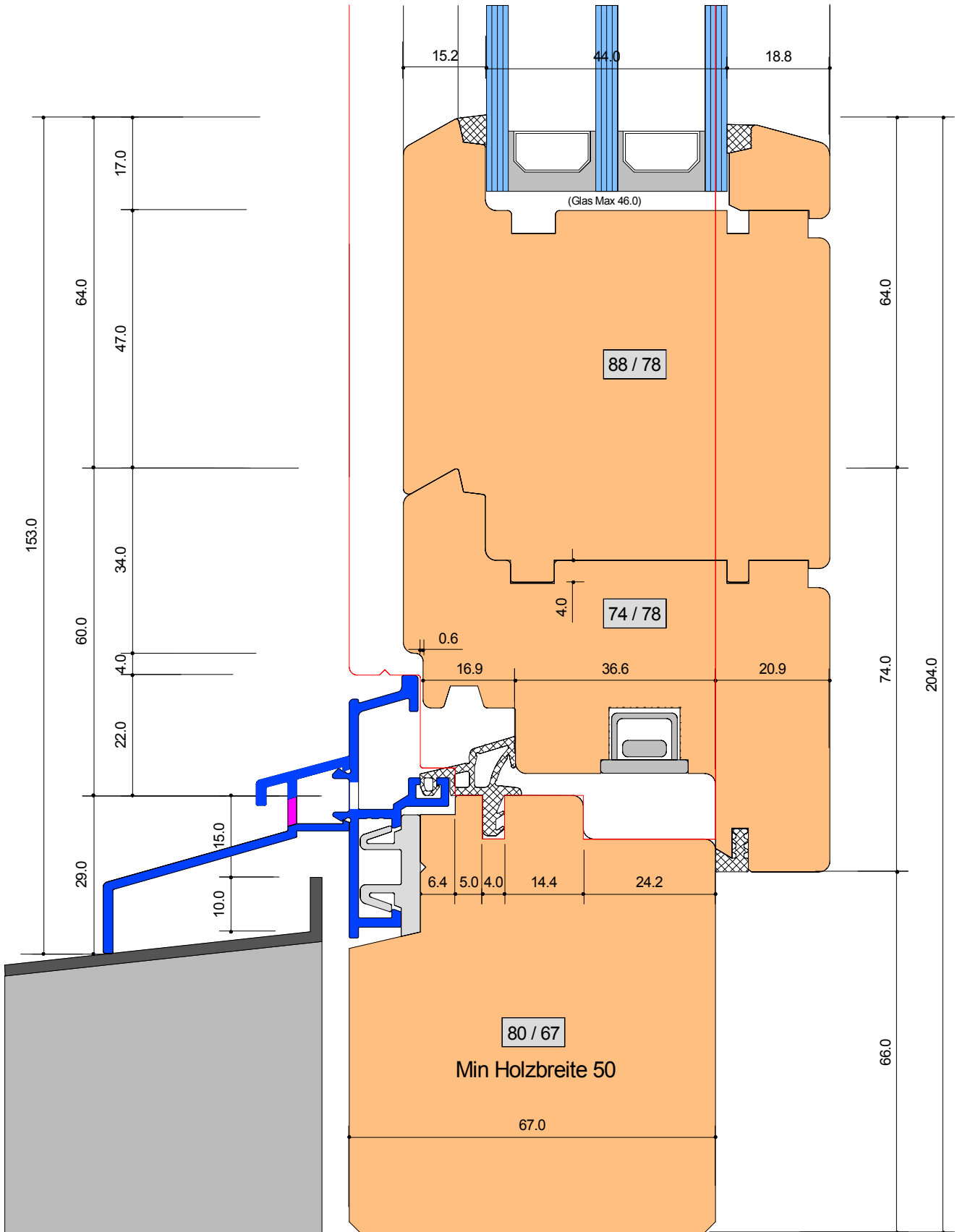

**SYSTEM: H-2 67-78**

Anschluss unten BT mit Einl 138 mm breit  
Wetterschenkel Typ RWS 045-013

Detail-Nr :	H - 2	D=006
-------------	-------	-------



Von Euw Fenster AG  
Schoosstrasse 2  
6418 Rothenthum

Tel 041 839 80 50  
Fax 041 839 80 60  
mail info@voneuw.ch

Ersteller: Adi von Euw  
Datum: 27.10.15  
Revidiert:

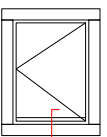

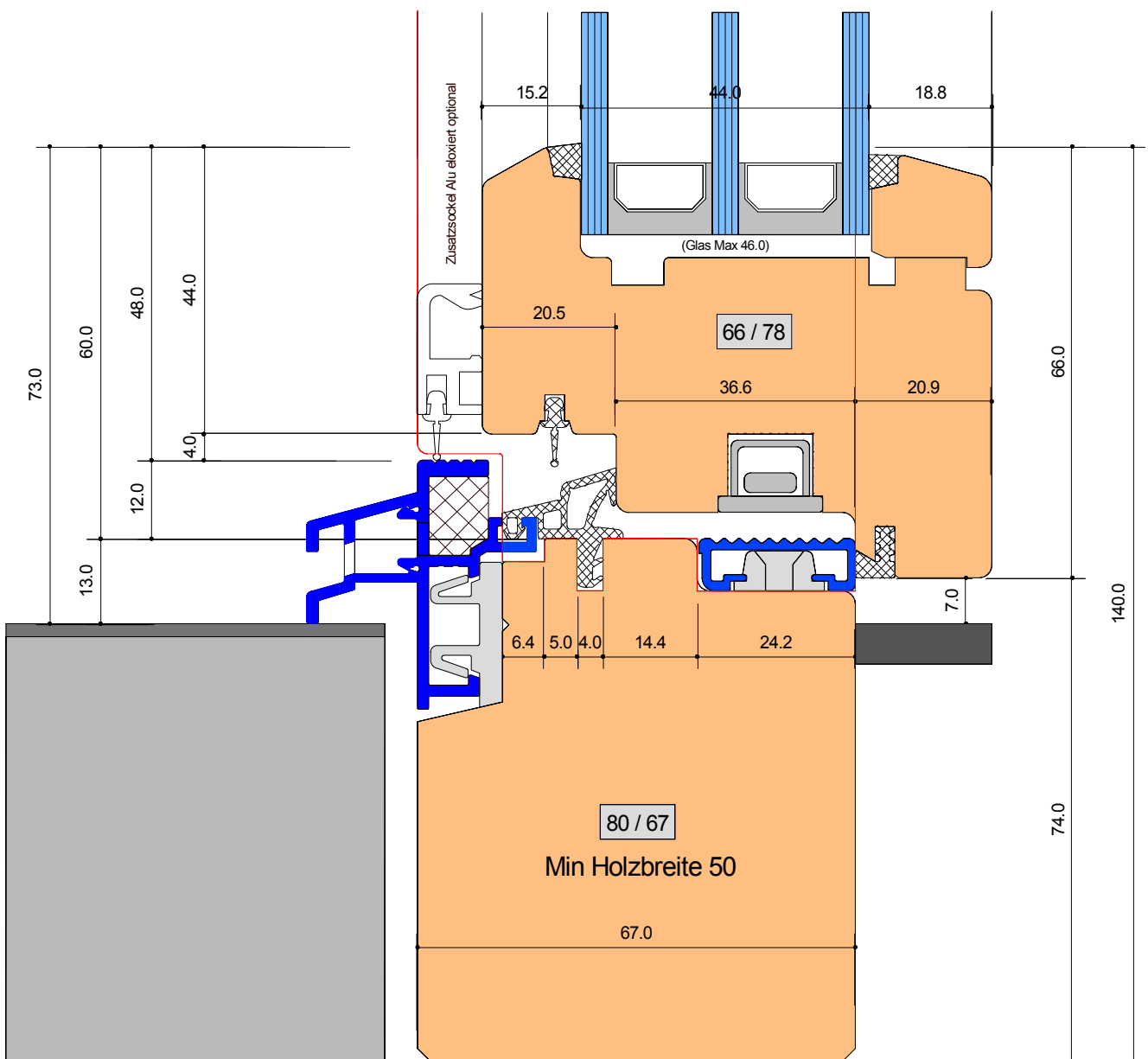

## SYSTEM: H-2 67-78

Anschluss unten Rollstuhlgängig BT 62 (70 mm)  
 Grundprofil M1-GR 038-18 Roll / Steckteil Variabel

Detail-Nr :	H - 2	D=021
-------------	-------	-------

Ersteller: Adi von Euw  
 Datum: 27.10.15  
 Revidiert: 11.10.19



Von Euw Fenster AG  
 Schoosstrasse 2  
 6418 Rothenthurm

Tel 041 839 80 50  
 Fax 041 839 80 60  
 mail info@voneuw.ch

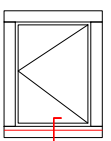

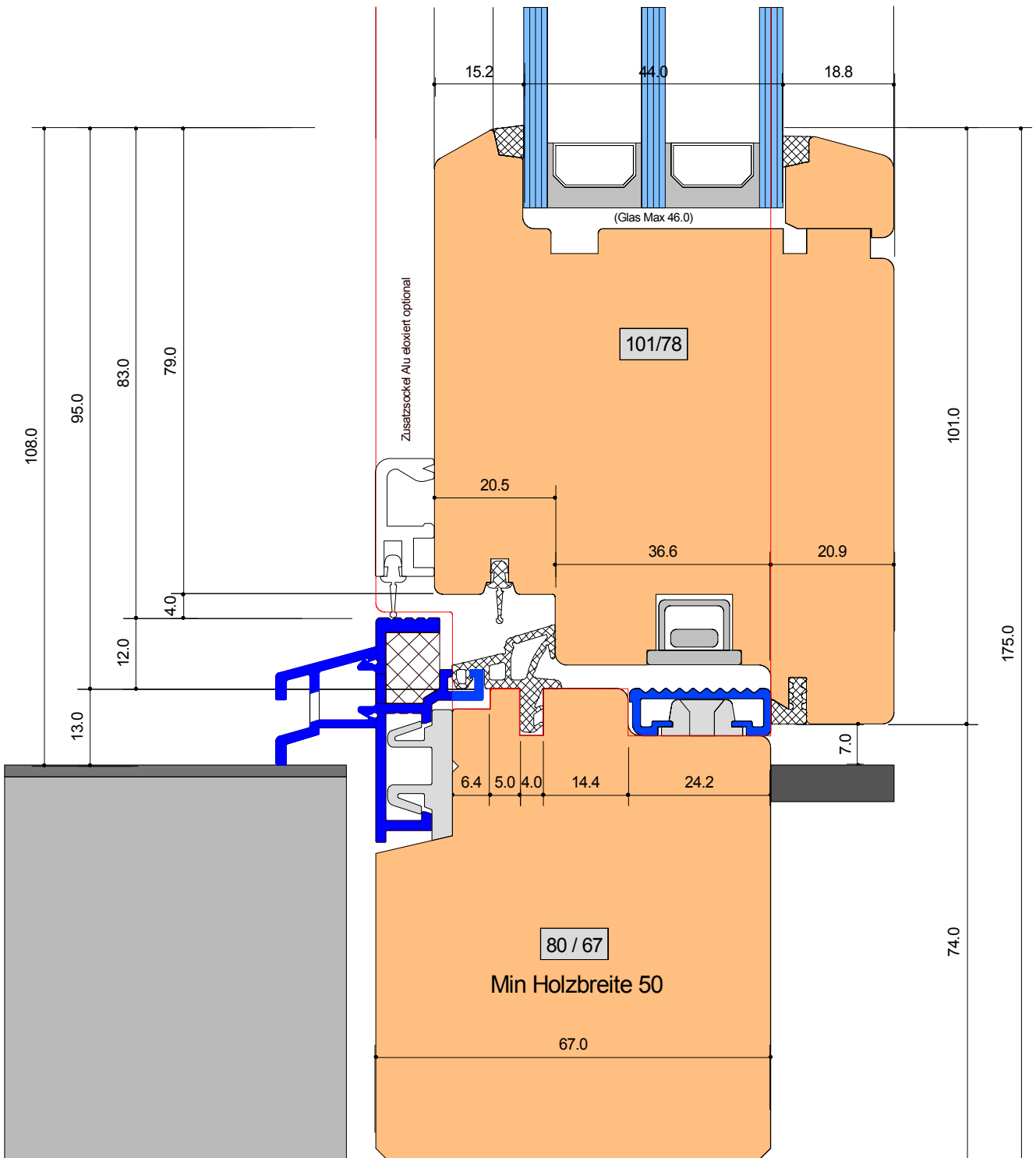

# SYSTEM: H-2 67-78

Anschluss unten Rollstuhlgängig BT 101 mm  
 Grundprofil M1-GR 038-18 Roll / Steckteil Variabel

Detail-Nr :	H - 2	D=022
-------------	-------	-------



Von Euw Fenster AG  
 Schoosstrasse 2  
 6418 Rothenthurm

Tel 041 839 80 50  
 Fax 041 839 80 60  
 mail info@voneuw.ch

Ersteller: Adi von Euw  
 Datum: 27.10.15  
 Revidiert: 11.10.19

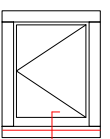

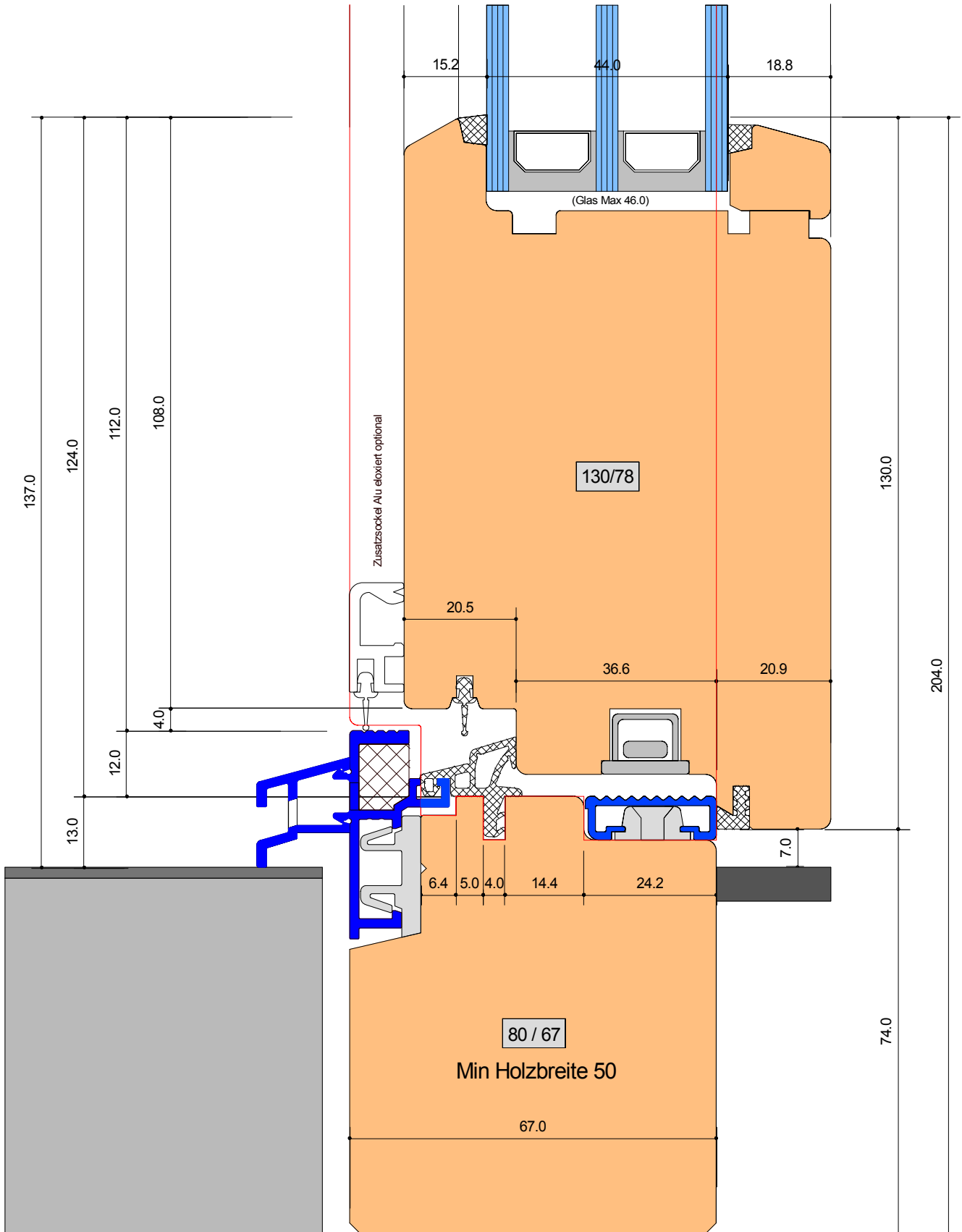

**SYSTEM: H-2 67-78**

Anschluss unten Rollstuhlgängig BT 130 mm  
 Grundprofil M1-GR 038-18 Roll / Steckteil Variabel

Detail-Nr :	H - 2	D=023
-------------	-------	-------



Von Euw Fenster AG  
 Schoosstrasse 2  
 6418 Rothenthurm

Tel 041 839 80 50  
 Fax 041 839 80 60  
 mail info@voneuw.ch

Ersteller: Adi von Euw  
 Datum: 27.10.15  
 Revidiert: 11.10.19

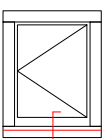



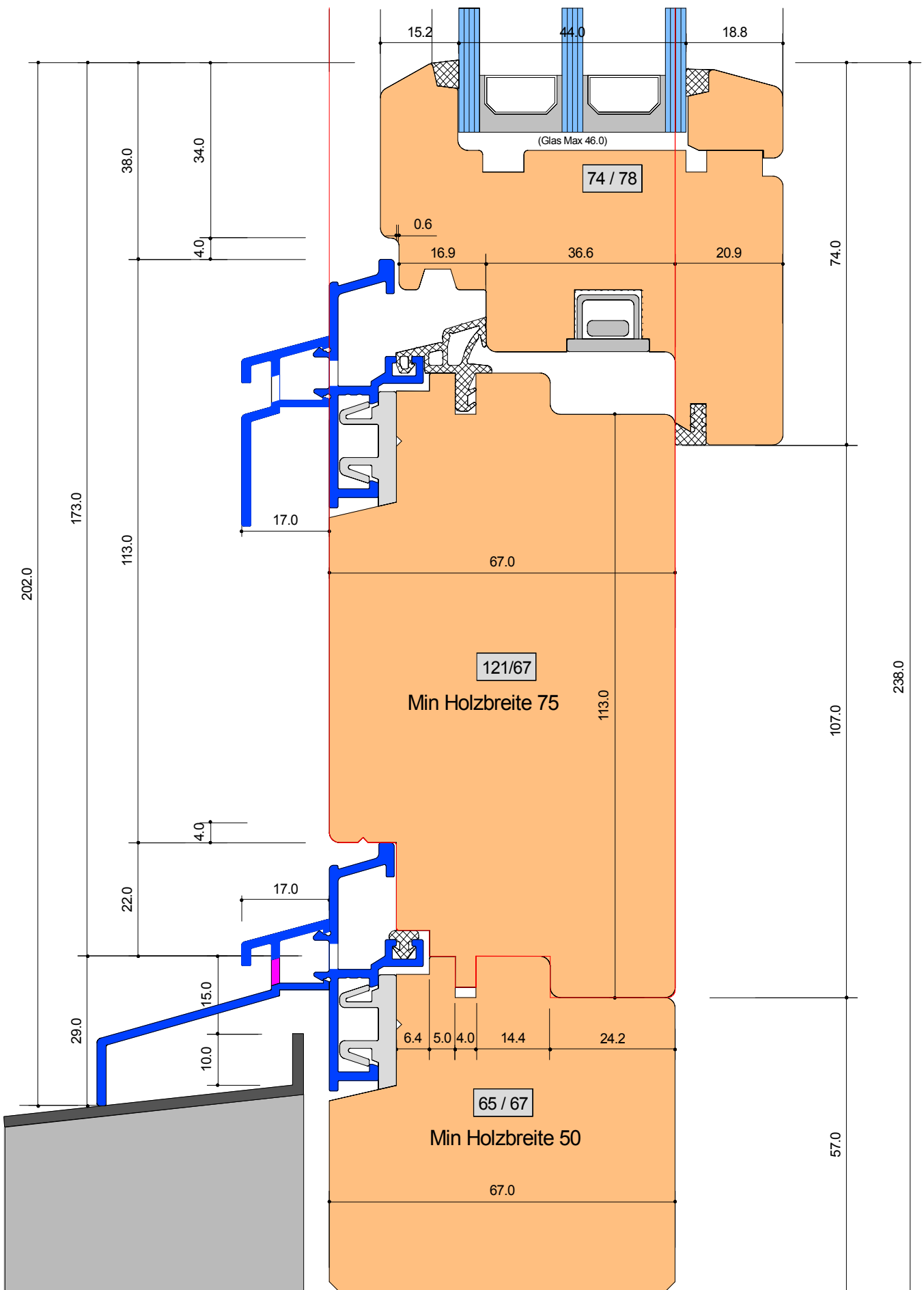

## SYSTEM: H-2 67-78

Anschluss unten mit Einleimer  
Wetterschenkel Typ RWS 045-013

Detail-Nr : H - 2 D=031



Von Euw Fenster AG  
Schoosstrasse 2  
6418 Rothenthurm

Tel 041 839 80 50  
Fax 041 839 80 60  
mail info@voneuw.ch

Ersteller: Adi von Euw  
Datum: 27.10.15  
Revidiert:

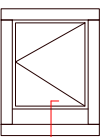

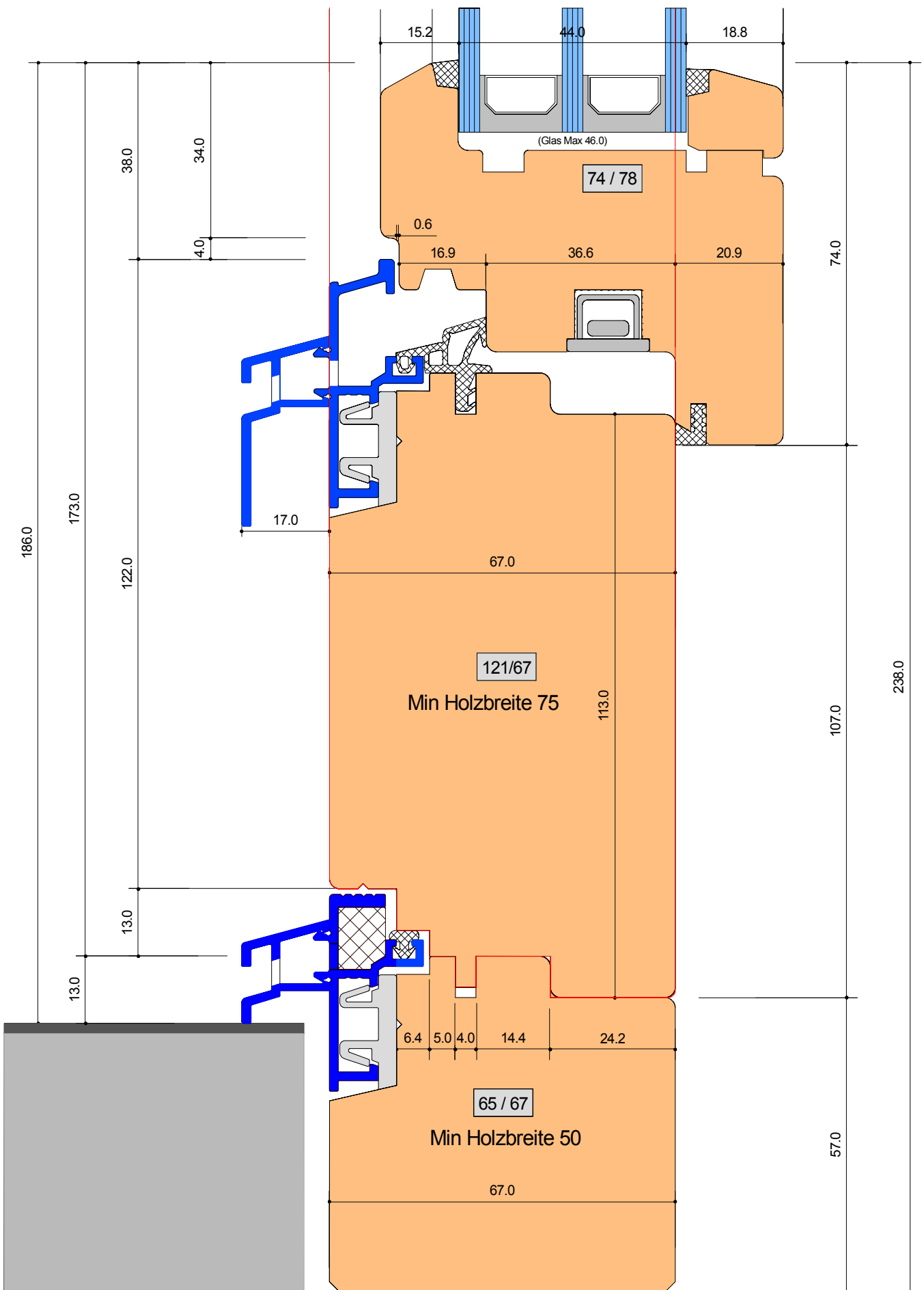

# SYSTEM: H-2 67-78

Anschluss unten Rollstuhlgängig mit Einleimer  
 Grundprofil M1-GR 038-18 Roll / Steckteil Variabel

Detail-Nr :	H - 2	D=035
-------------	-------	-------



Von Euw Fenster AG  
 Schoosstrasse 2  
 6418 Rothenthurm

Tel 041 839 80 50  
 Fax 041 839 80 60  
 mail info@voneuw.ch

Ersteller: Adi von Euw  
 Datum: 27.10.15  
 Revidiert: 11.10.19

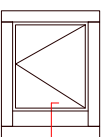

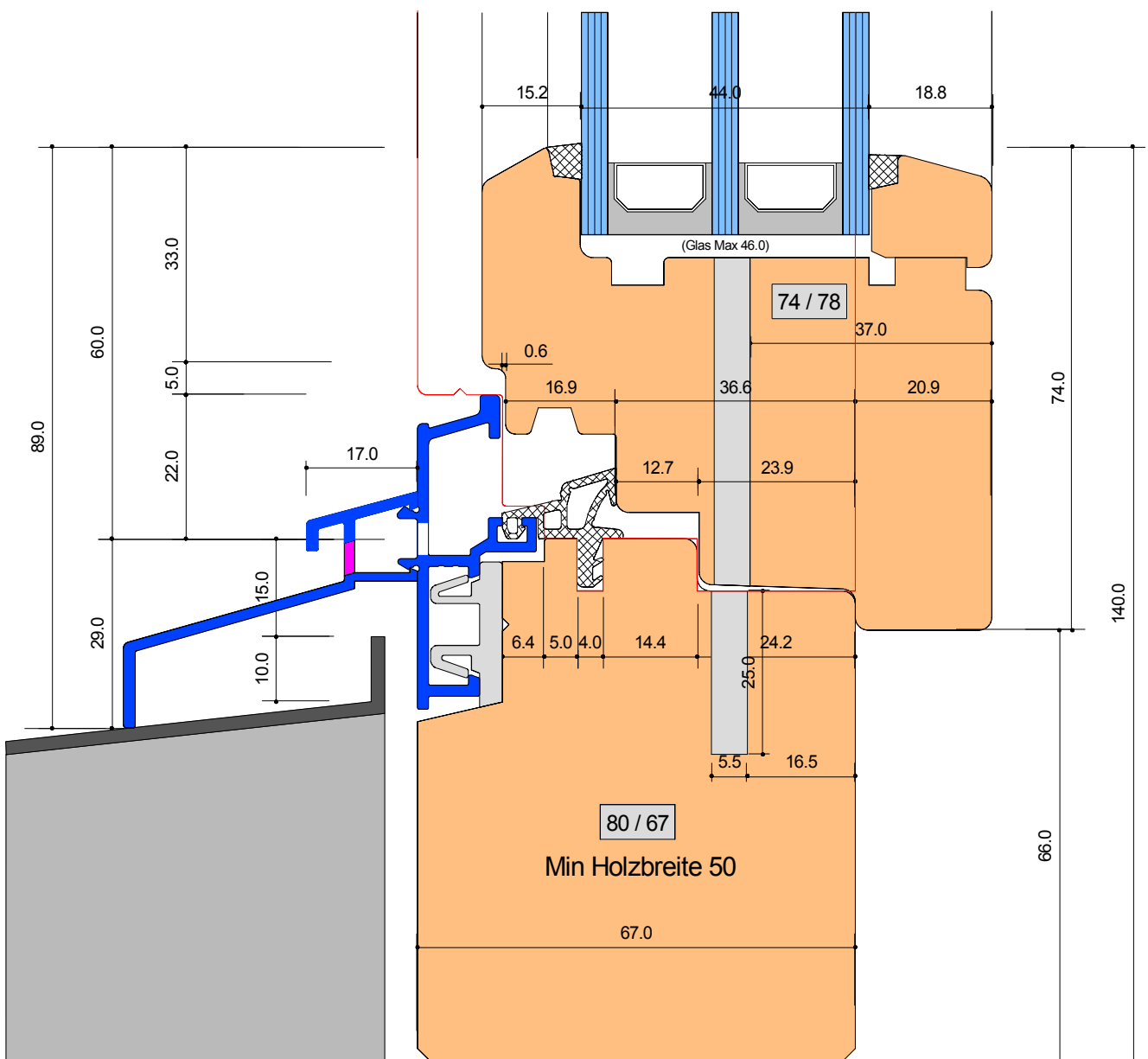

## SYSTEM: H-2 67-78

Anschluss unten mit Alu Fensterbank  
 Wetterschenkel Typ RWS 045-013  
 Fest verglast Flg Fest eingeschraubt Flg 74 mm

Detail-Nr :	H - 2	D=041
-------------	-------	-------



Von Euw Fenster AG  
 Schoosstrasse 2  
 6418 Rothenthurm

Tel 041 839 80 50  
 Fax 041 839 80 60  
 mail info@voneuw.ch

Ersteller: Adi von Euw  
 Datum: 27.10.15  
 Revidiert:

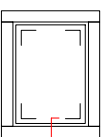

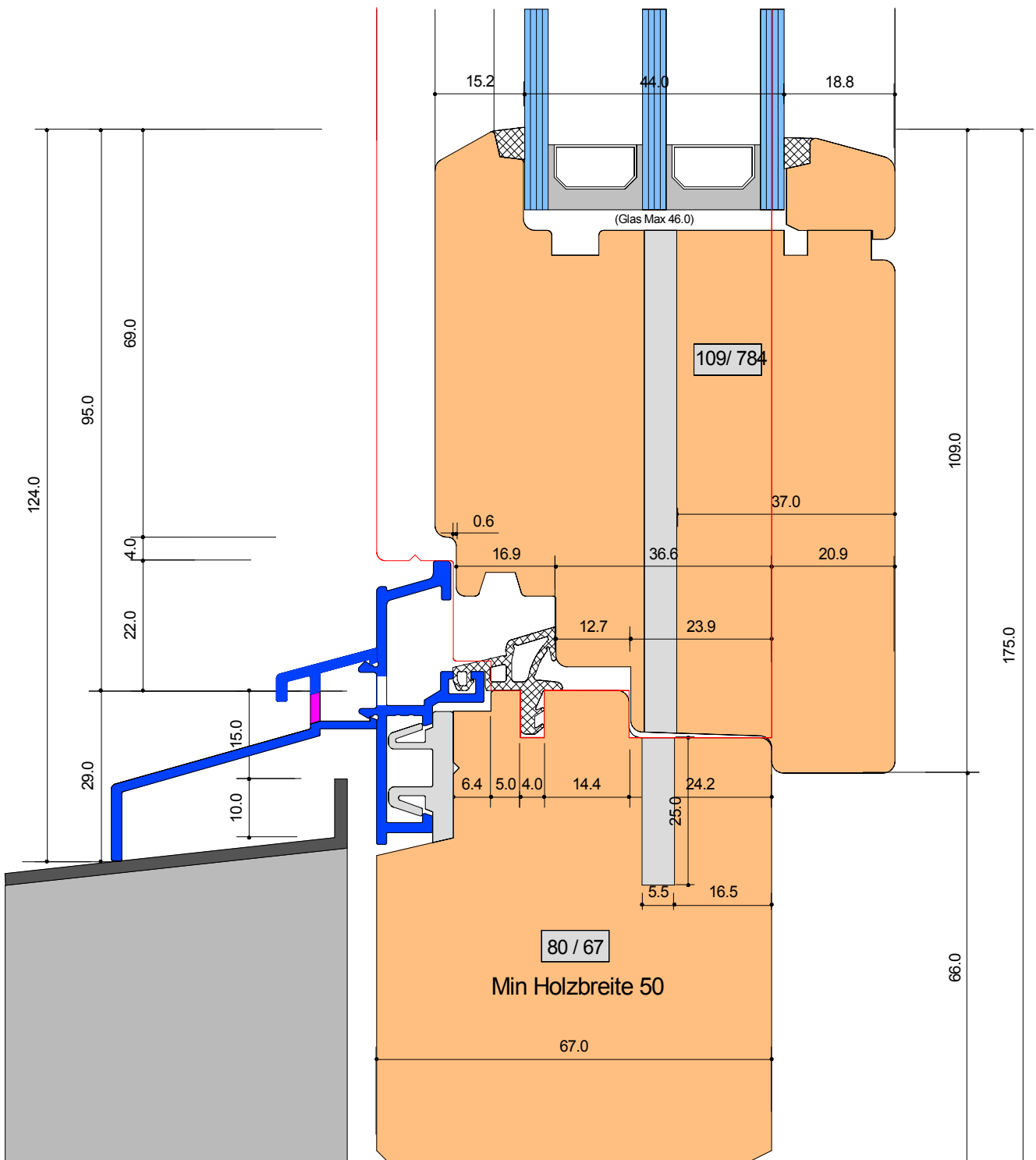

## SYSTEM: H-2 67-78

Anschluss unten mit Alu Fensterbank  
 Wetterschenkel Typ RWS 045-013  
 Fest verglast Flg Fest eingeschraubt Flg 109 mm

Detail-Nr :	H - 2	D=042
-------------	-------	-------



Von Euw Fenster AG  
 Schoosstrasse 2  
 6418 Rothenthurm

Tel 041 839 80 50  
 Fax 041 839 80 60  
 mail info@voneuw.ch

Ersteller: Adi von Euw  
 Datum: 27.10.15  
 Revidiert:

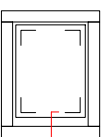

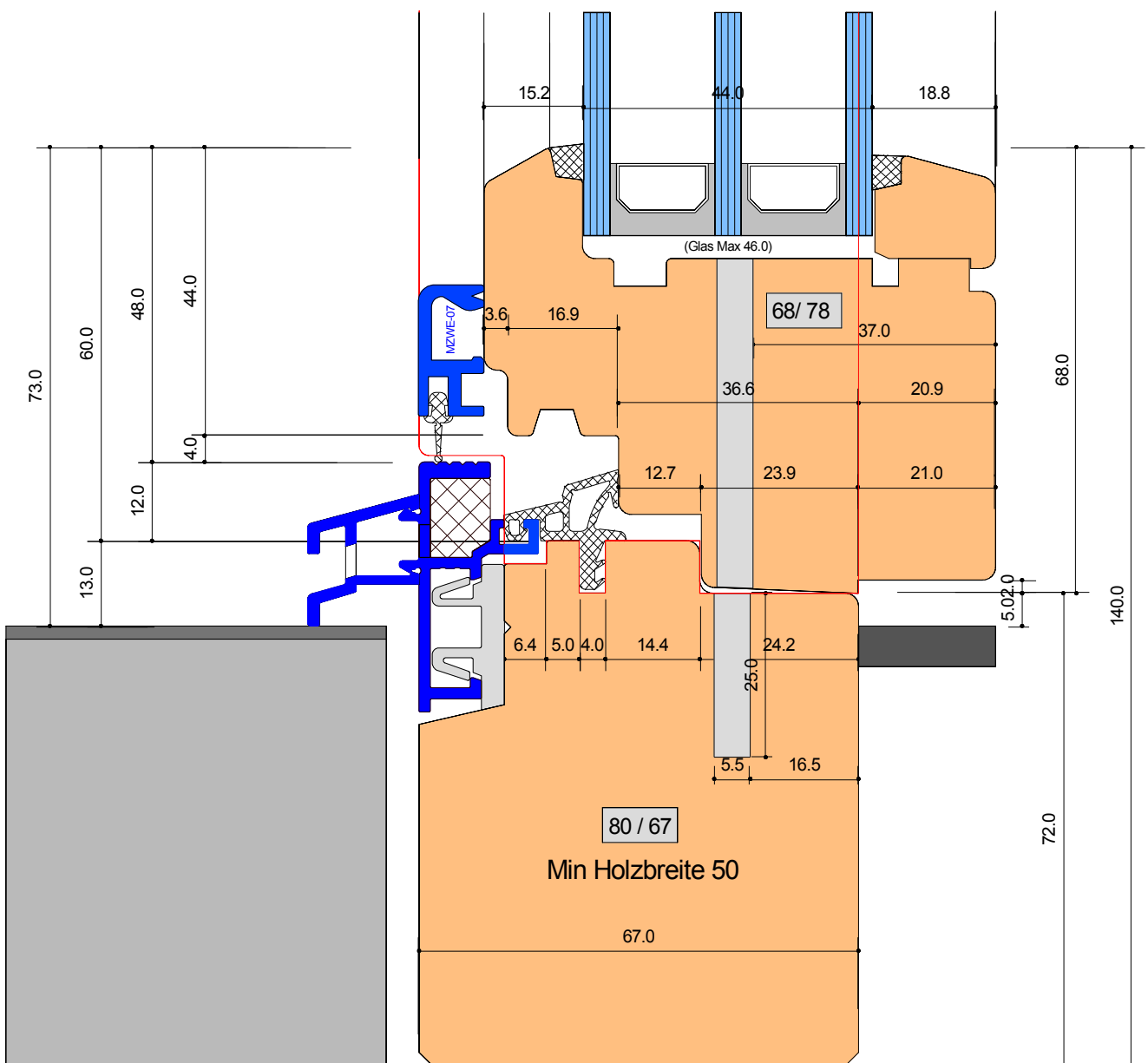

## SYSTEM: H-2 67-78

Anschluss unten Rollstuhlgängig BT 62 (70 mm)  
 Grundprofil M1-GR 038-18 Roll / Steckteil Variabel  
 Fest verglast Roll. Flg 68 mm (-6.0)

Detail-Nr :	H - 2	D=045
-------------	-------	-------



Von Euw Fenster AG  
 Schoosstrasse 2  
 6418 Rothenthurm

Tel 041 839 80 50  
 Fax 041 839 80 60

mail info@voneuw.ch

Ersteller: Adi von Euw  
 Datum: 27.10.15  
 Revidiert: 11.10.19

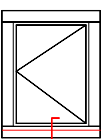

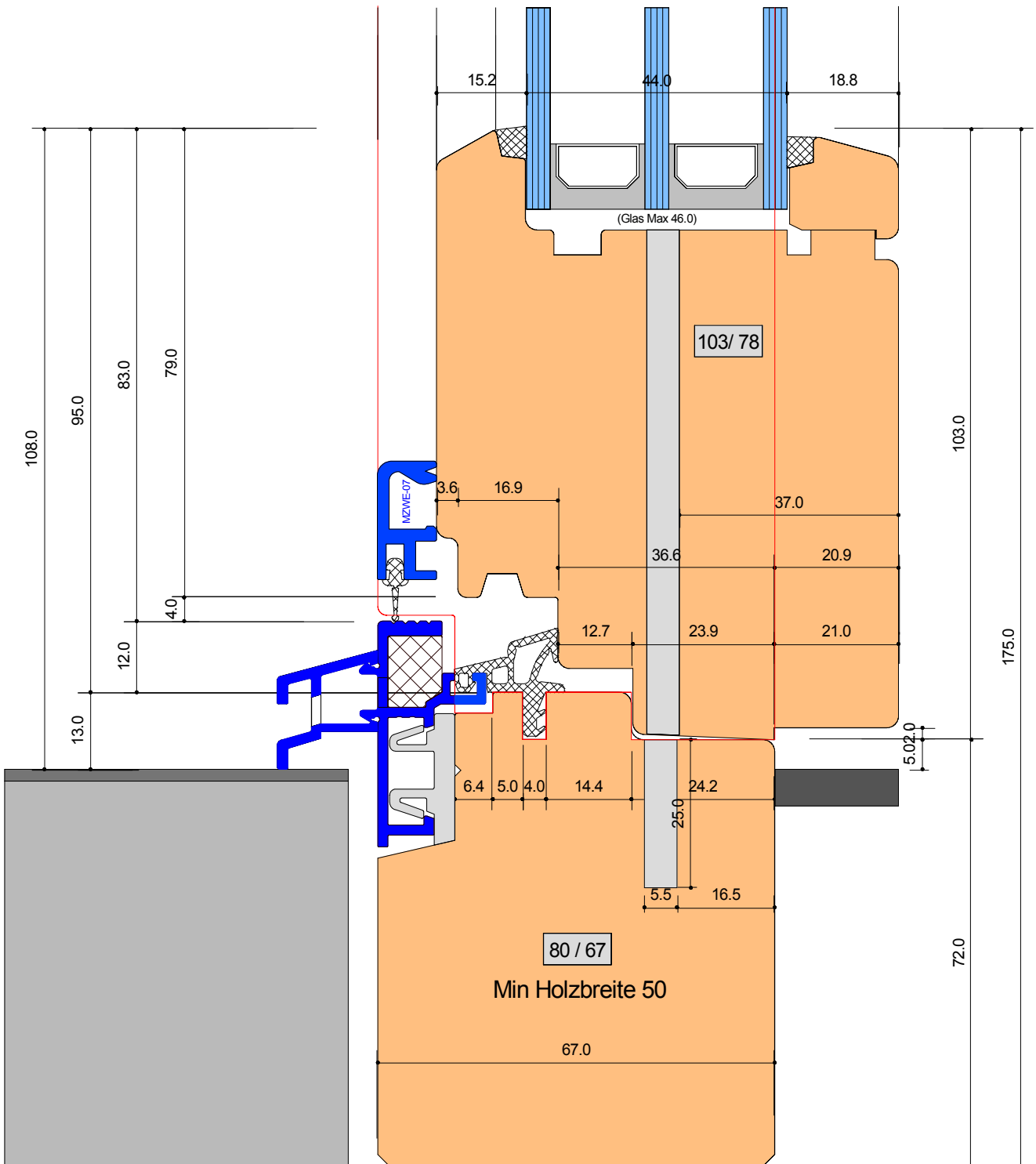

## SYSTEM: H-2 67-78

Anschluss unten Rollstuhlgängig BT 62 (70 mm)  
 Grundprofil M1-GR 038-18 Roll / Steckteil Variabel  
 Fest verglast Roll. Flg 103 mm (-6.0)

Detail-Nr :	H - 2	D=046
-------------	-------	-------



Von Euw Fenster AG  
 Schoosstrasse 2  
 6418 Rothenthurm

Tel 041 839 80 50  
 Fax 041 839 80 60  
 mail info@voneuw.ch

Ersteller: Adi von Euw  
 Datum: 27.10.15  
 Revidiert: 11.10.19

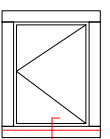

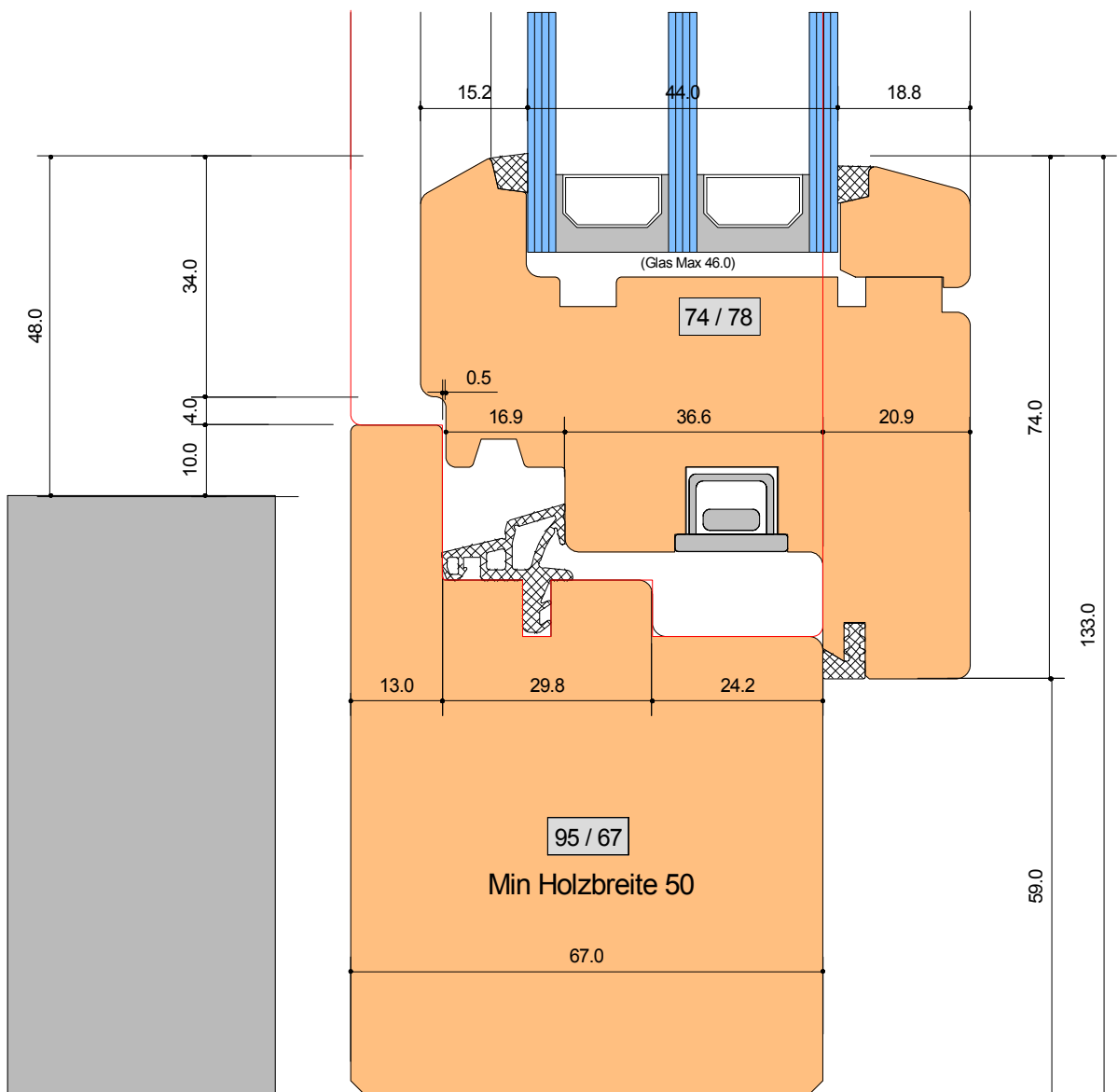

# SYSTEM: H-2 67-78

Anschluss seitlich Standart Fig 74

Detail-Nr :	H - 2	D=201
-------------	-------	-------

Ersteller: Adi von Euw  
 Datum: 27.10.15  
 Revidiert:



Von Euw Fenster AG  
 Schoosstrasse 2  
 6418 Rothenthurm

Tel 041 839 80 50  
 Fax 041 839 80 60  
 mail info@voneuw.ch

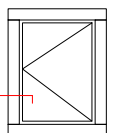

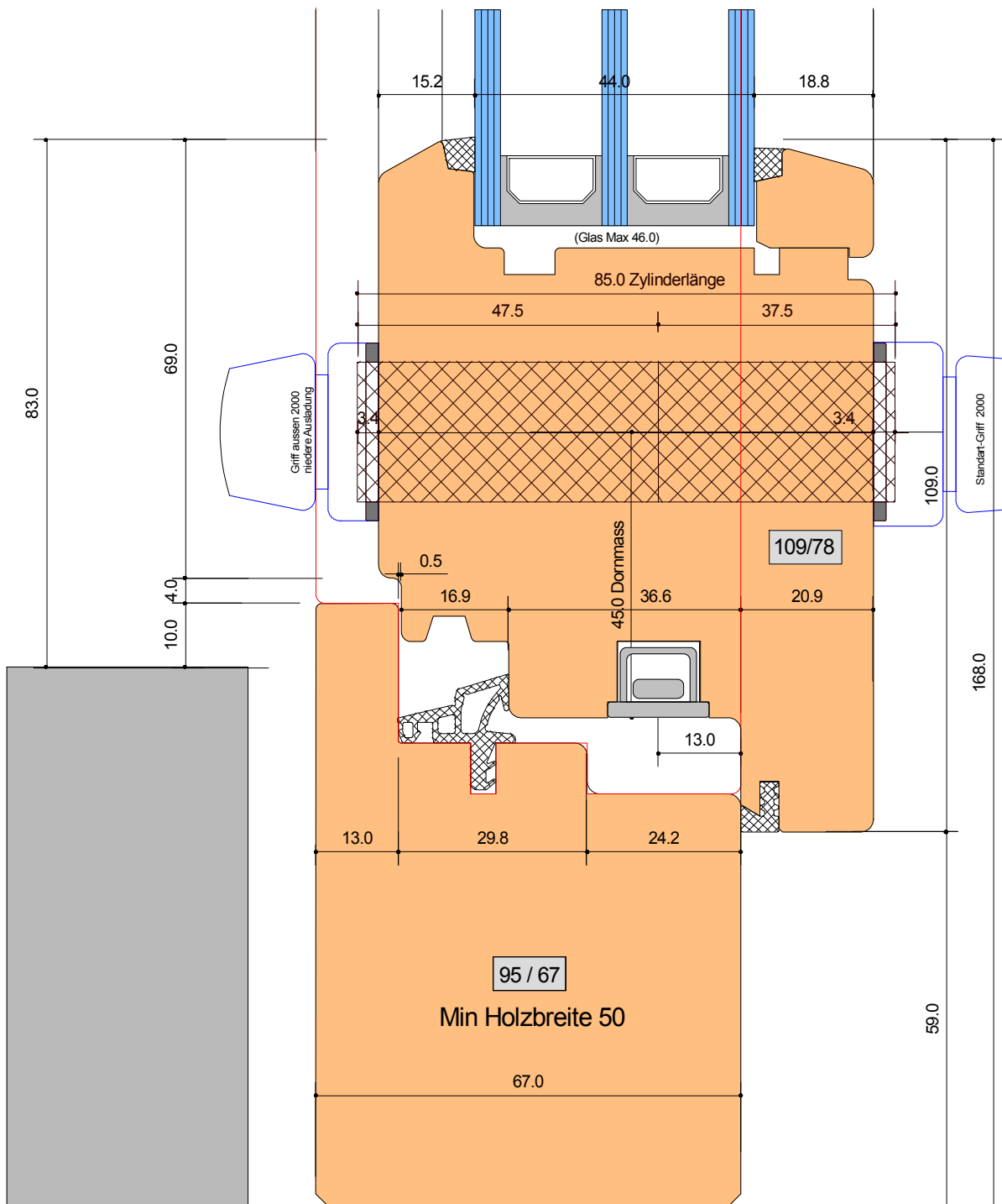

# SYSTEM: H-2 67-78

Anschluss seitlich Standart Flg 109 mm  
 Verschluss durchg. D=45.0 mm Griff m.Knopf/Schlüssel  
 Variante: Verschluss durchg. D=45.0 mm mit Zylinder

Detail-Nr :	H - 2	D=205
-------------	-------	-------



Von Euw Fenster AG  
 Schoosstrasse 2  
 6418 Rothenthurm

Tel 041 839 80 50  
 Fax 041 839 80 60  
 mail info@voneuw.ch

Ersteller: Adi von Euw  
 Datum: 16.06.16  
 Revidiert:

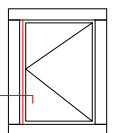



**Variante 1**  
 Schutzschild Glutz  
 ES1 5430S mit Zyl.  
 Schutzrosette (10-14 mm)

**Variante 1**  
 Innenschild Glutz  
 ES1 5435C.2 gerade

**Variante 2**  
 Rund-Schutzrosette Glutz  
 ES1 5330.2S-RS mit Schutz-  
 Einsatz (7-12 einwärts)

**Variante 2**  
 Rund-Rosette innen Glutz  
 5330.C mit Grundplatte

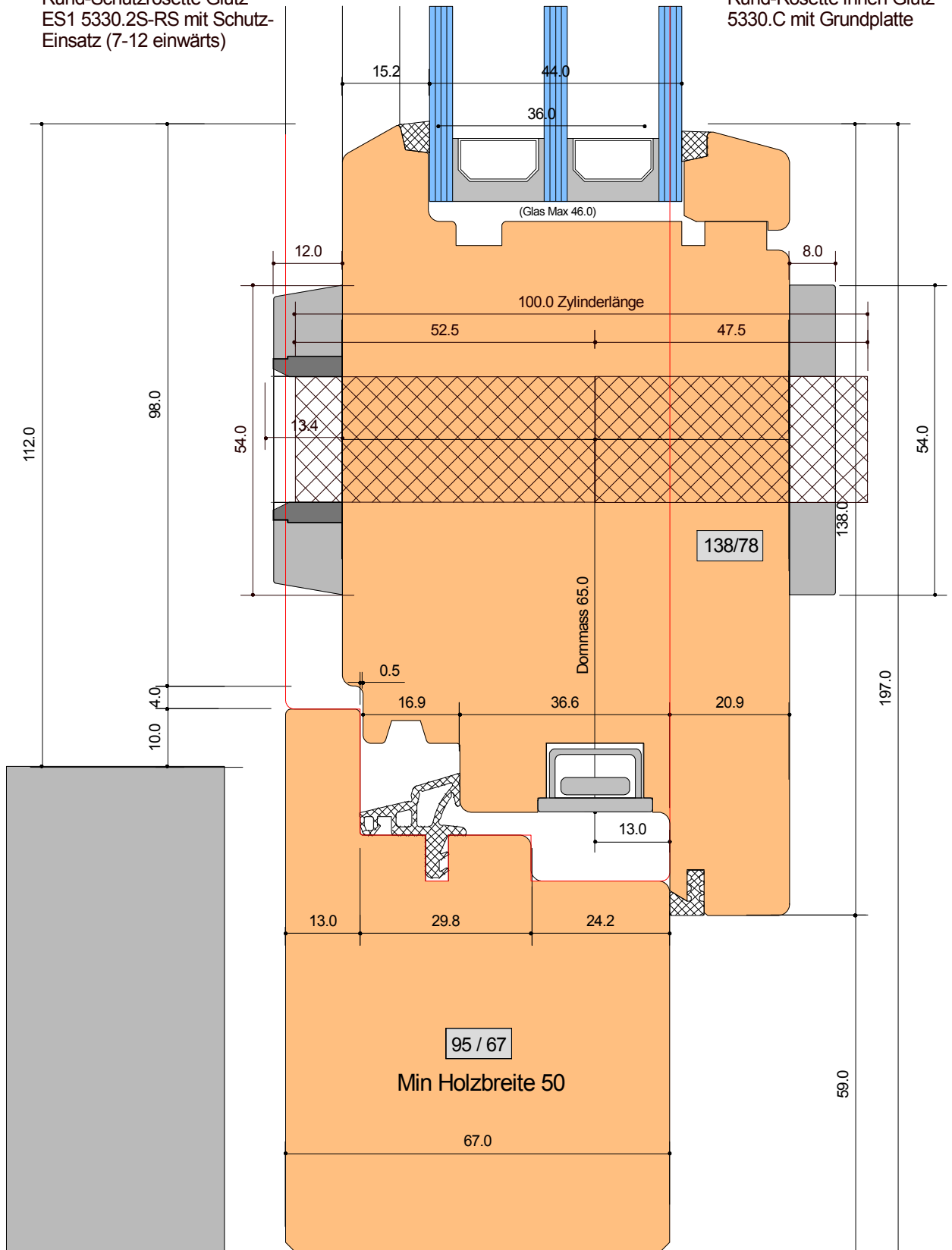

## SYSTEM: H-2 67-78

Anschluss seitlich mit Haustürverschluss Fig 138  
 mit Haustürverschluss D=65 mm  
 mit Sicherheitslängschild Glutz 5430S/5435C.2  
 mit Rund-Ros Glutz ES1 5330.2S-RS/5330C

Detail-Nr : H - 2 D=210



Von Euw Fenster AG  
 Schoosstrasse 2  
 6418 Rothenthurm

Tel 041 839 80 50  
 Fax 041 839 80 60  
 mail info@voneuw.ch

Ersteller: Adi von Euw  
 Datum: 16.06.16  
 Revidiert:

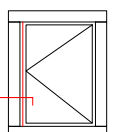

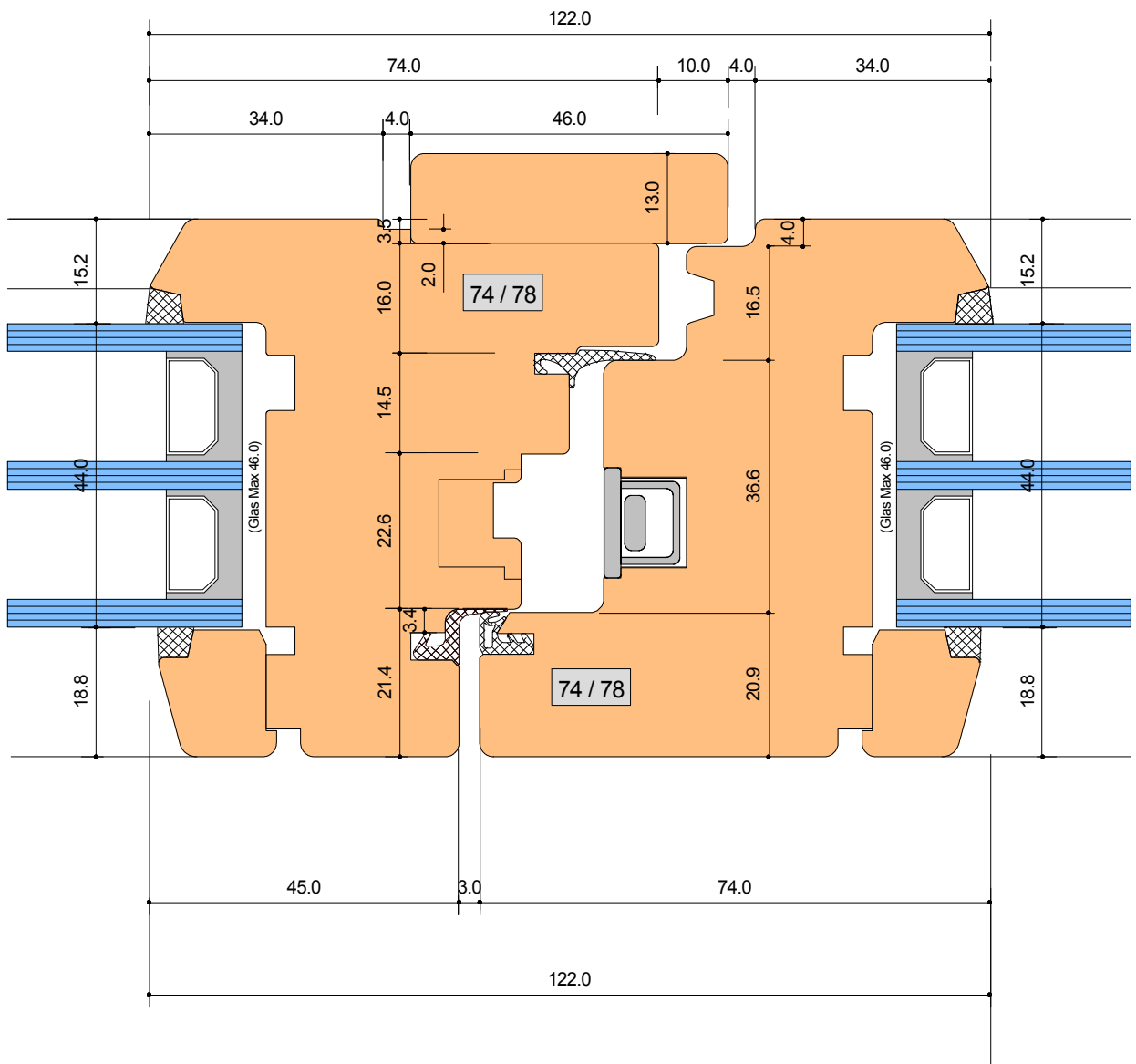

# SYSTEM: H-2 67-78

Mittelpartie standard mit 2 x 74 mm Flg

Detail-Nr :	H - 2	D=301
-------------	-------	-------

Ersteller: Adi von Euw  
 Datum: 27.10.15  
 Revidiert:



Von Euw Fenster AG  
 Schoosstrasse 2  
 6418 Rothenthurm

Tel 041 839 80 50  
 Fax 041 839 80 60  
 mail info@voneuw.ch

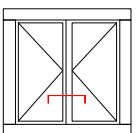

# Lichtoptimiert

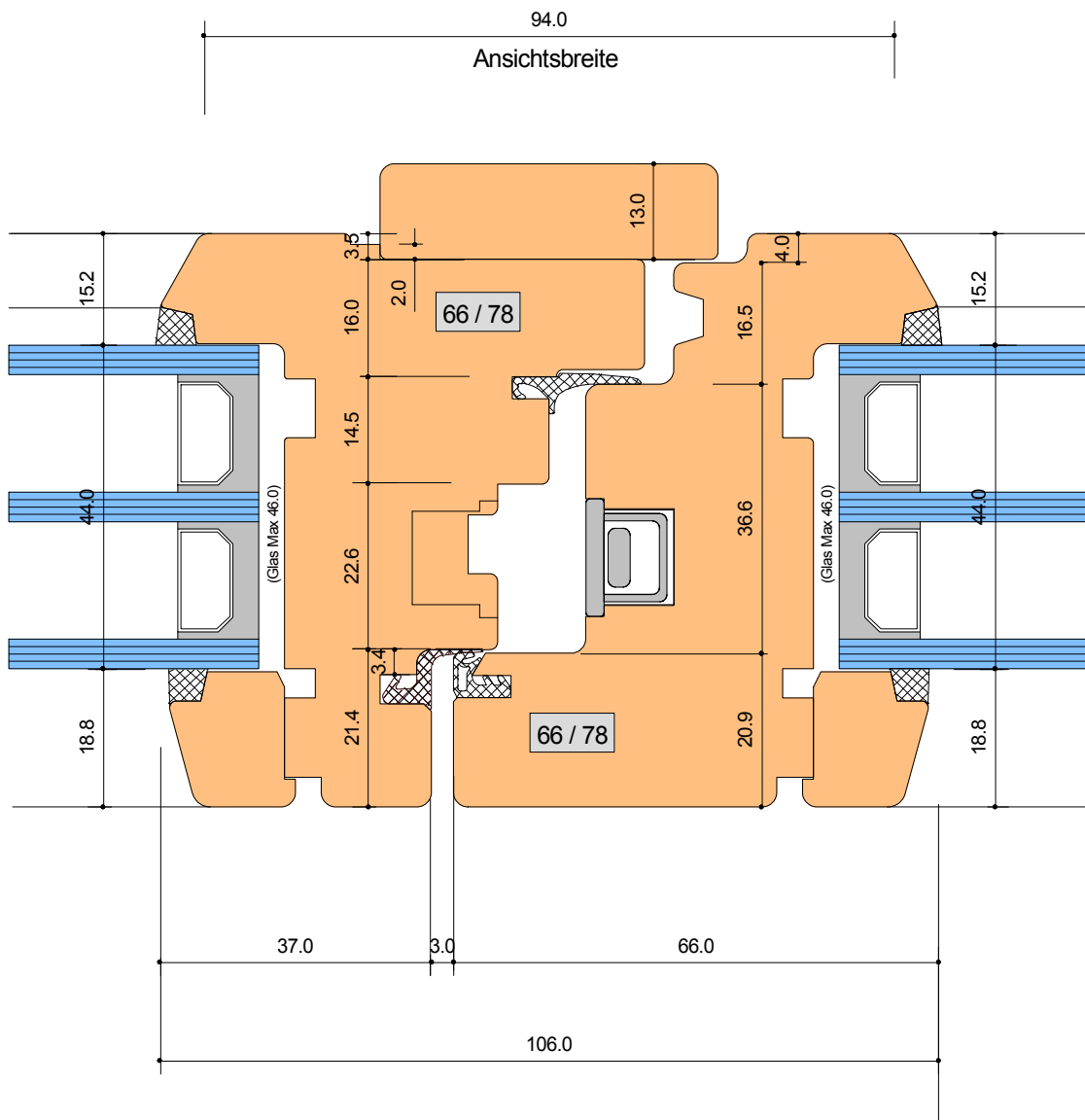

## SYSTEM: H-2 67-78

Mittelpartie schmal mit 2 x 66 mm  
mit Reduziergetriebe D 7 mm

Detail-Nr :	H - 2	D=302
-------------	-------	-------



Von Euw Fenster AG  
Schoosstrasse 2  
6418 Rothenthurm

Tel 041 839 80 50  
Fax 041 839 80 60  
mail info@voneuw.ch

Ersteller: Adi von Euw  
Datum: 27.10.15  
Revidiert:

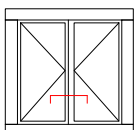

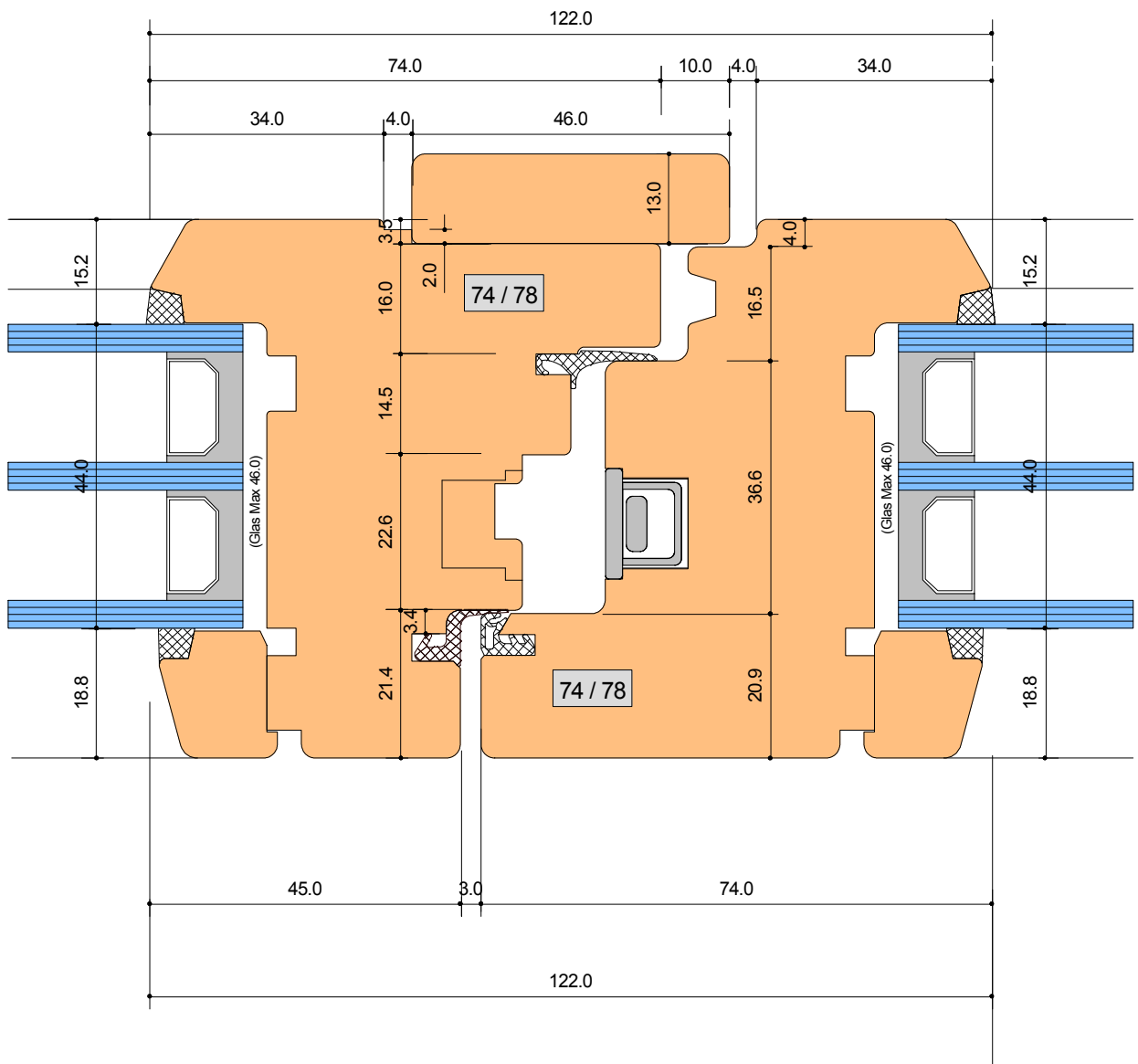

# SYSTEM: H-2 67-78

Mittelpartie einseitig mit fest vergl. Fig v. aussen

Detail-Nr :	H - 2	D=310
-------------	-------	-------



Von Euw Fenster AG  
Schoosstrasse 2  
6418 Rothenthurm

Tel 041 839 80 50  
Fax 041 839 80 60  
mail info@voneuw.ch

Ersteller: Adi von Euw  
Datum: 27.10.15  
Revidiert:

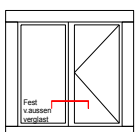

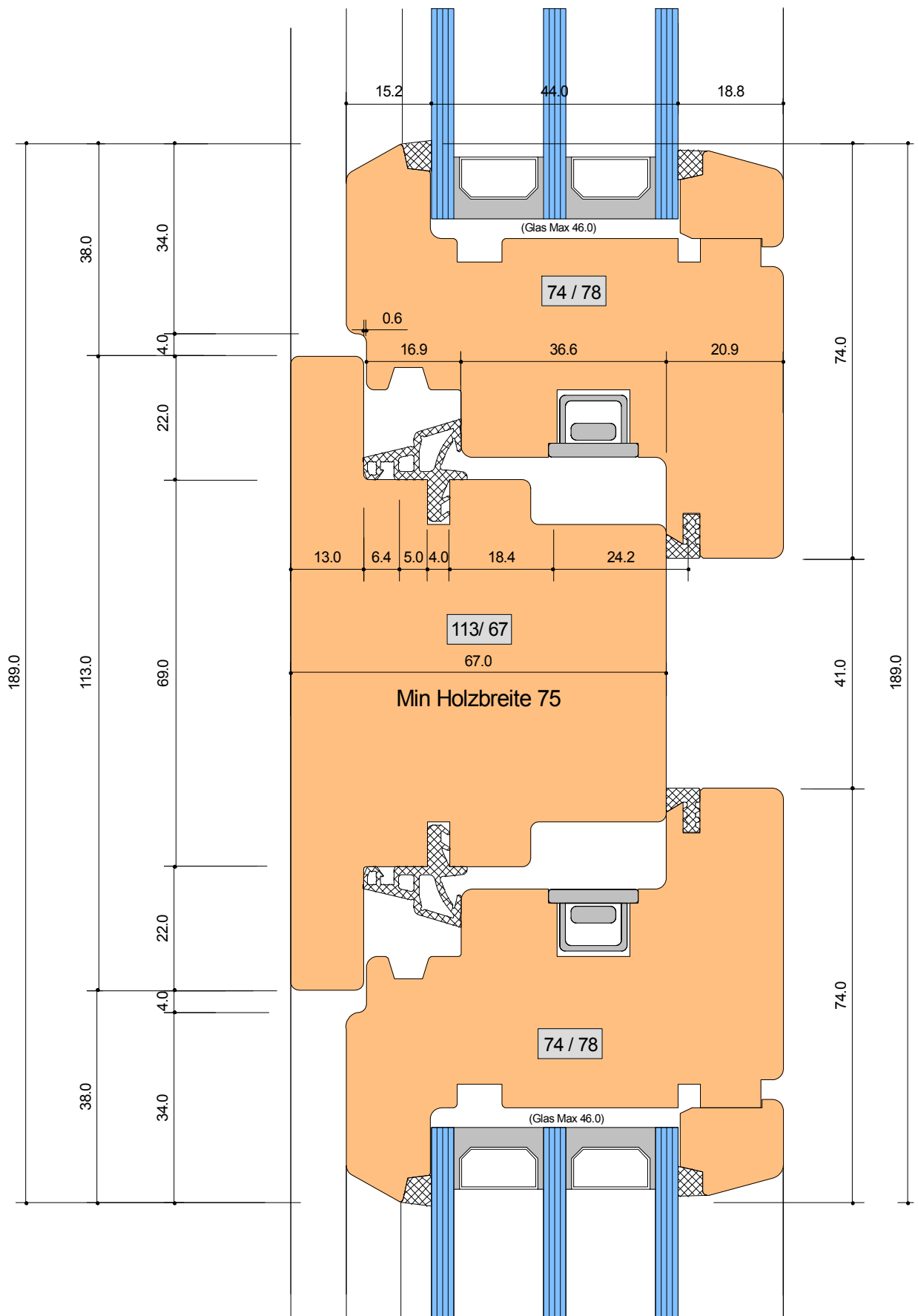

# SYSTEM: H-2 67-78

Setzholz 113 mm

Detail-Nr : H - 2 D=401

Ersteller: Adi von Euw  
 Datum: 27.10.15  
 Revidiert:



Von Euw Fenster AG  
 Schoosstrasse 2  
 6418 Rothenthurm

Tel 041 839 80 50  
 Fax 041 839 80 60  
 mail info@voneuw.ch

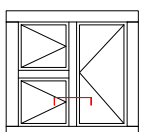

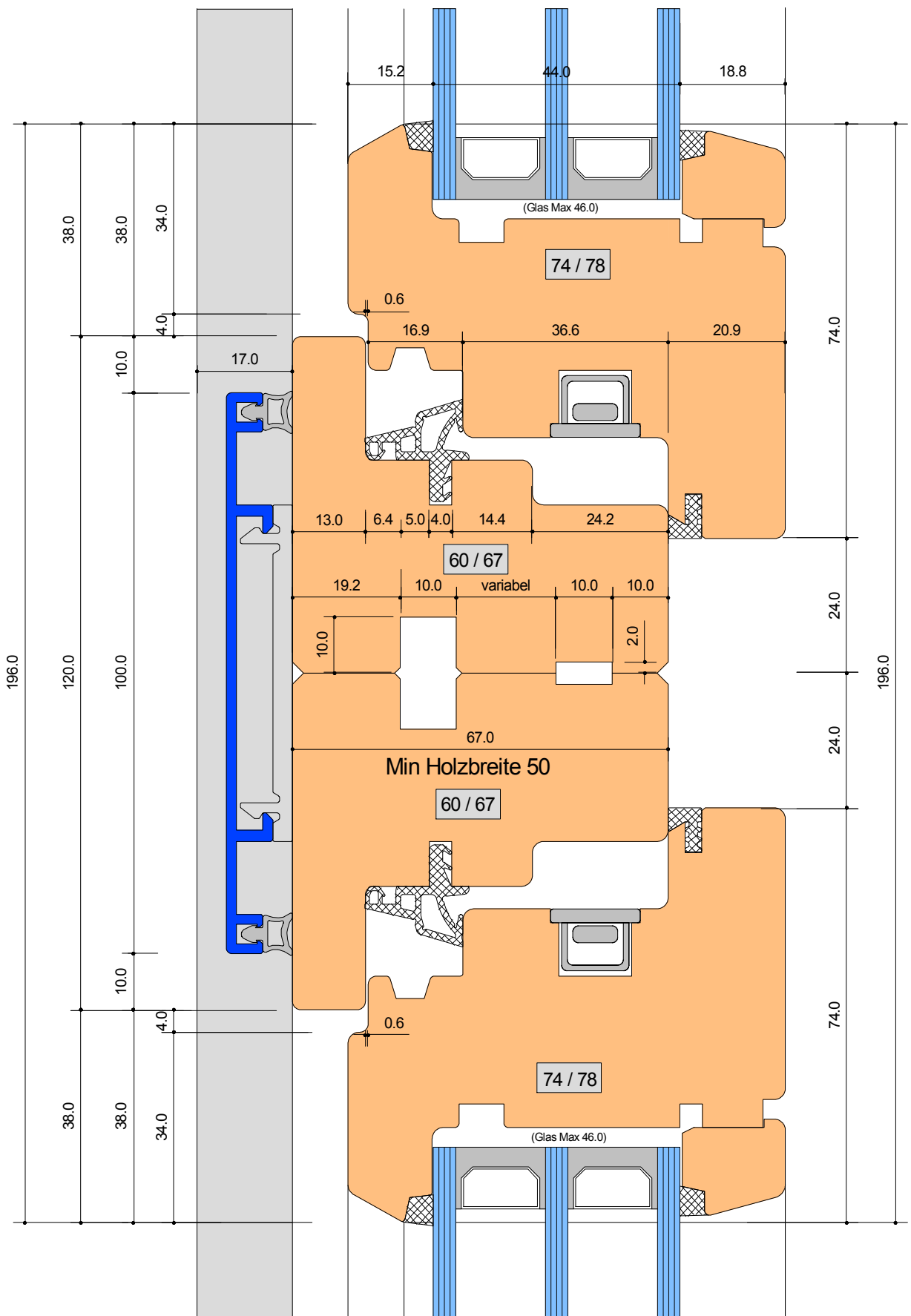

# SYSTEM: H-2 67-78

Kombinationszusammenbau Nut + Feder

Detail-Nr :	H - 2	D=405
-------------	-------	-------

Ersteller: Adi von Euw  
 Datum: 27.10.15  
 Revidiert:



Von Euw Fenster AG  
 Schoosstrasse 2  
 6418 Rothenthurm

Tel 041 839 80 50  
 Fax 041 839 80 60  
 mail info@voneuw.ch

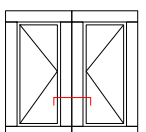

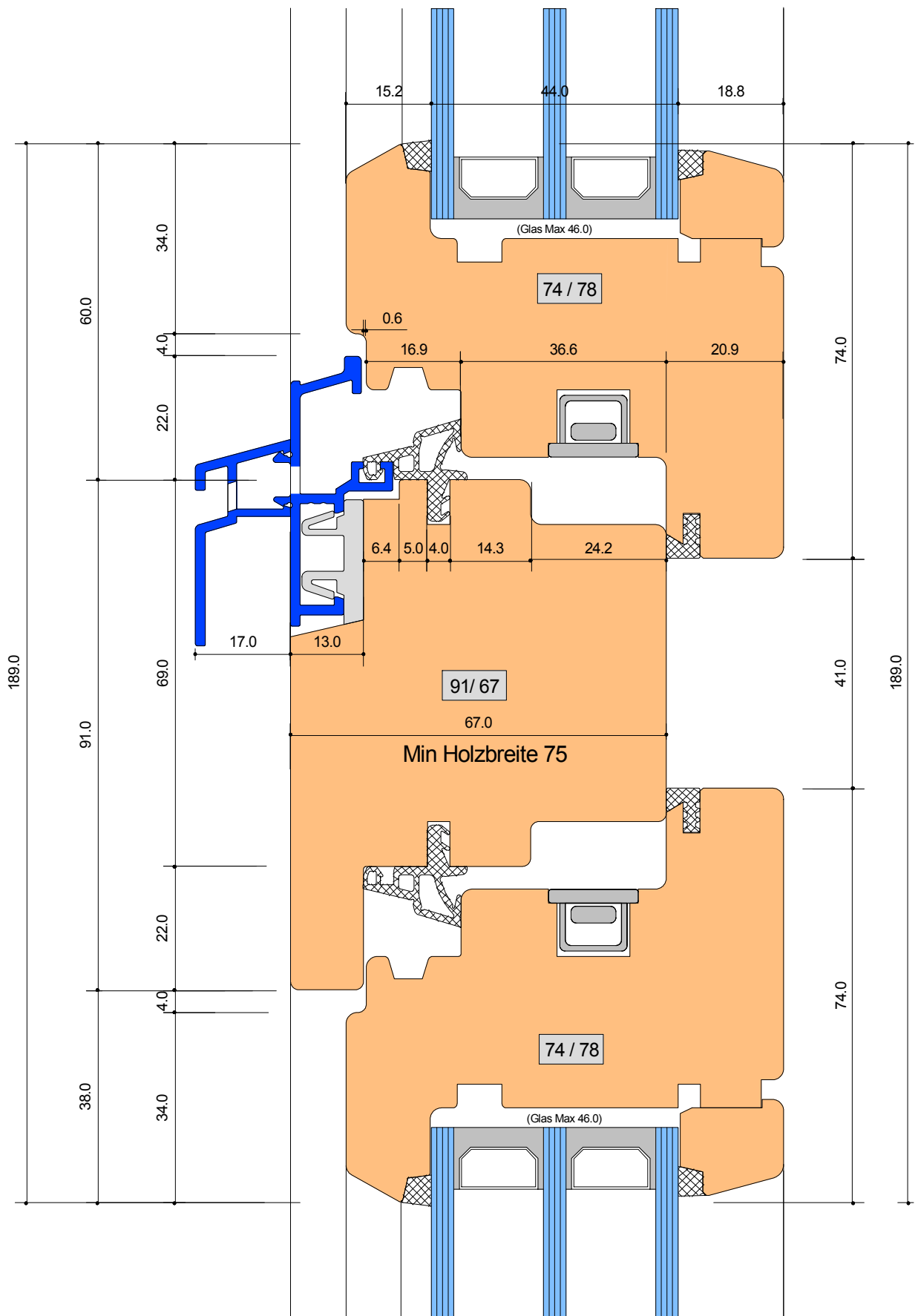

**SYSTEM: H-2 67-78**

Kämpfer

Detail-Nr :	H - 2	D=501
-------------	-------	-------

Ersteller: Adi von Euw  
 Datum: 27.10.15  
 Revidiert:



Von Euw Fenster AG  
 Schoosstrasse 2  
 6418 Rothenthurm

Tel 041 839 80 50  
 Fax 041 839 80 60  
 mail info@voneuw.ch

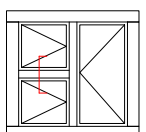

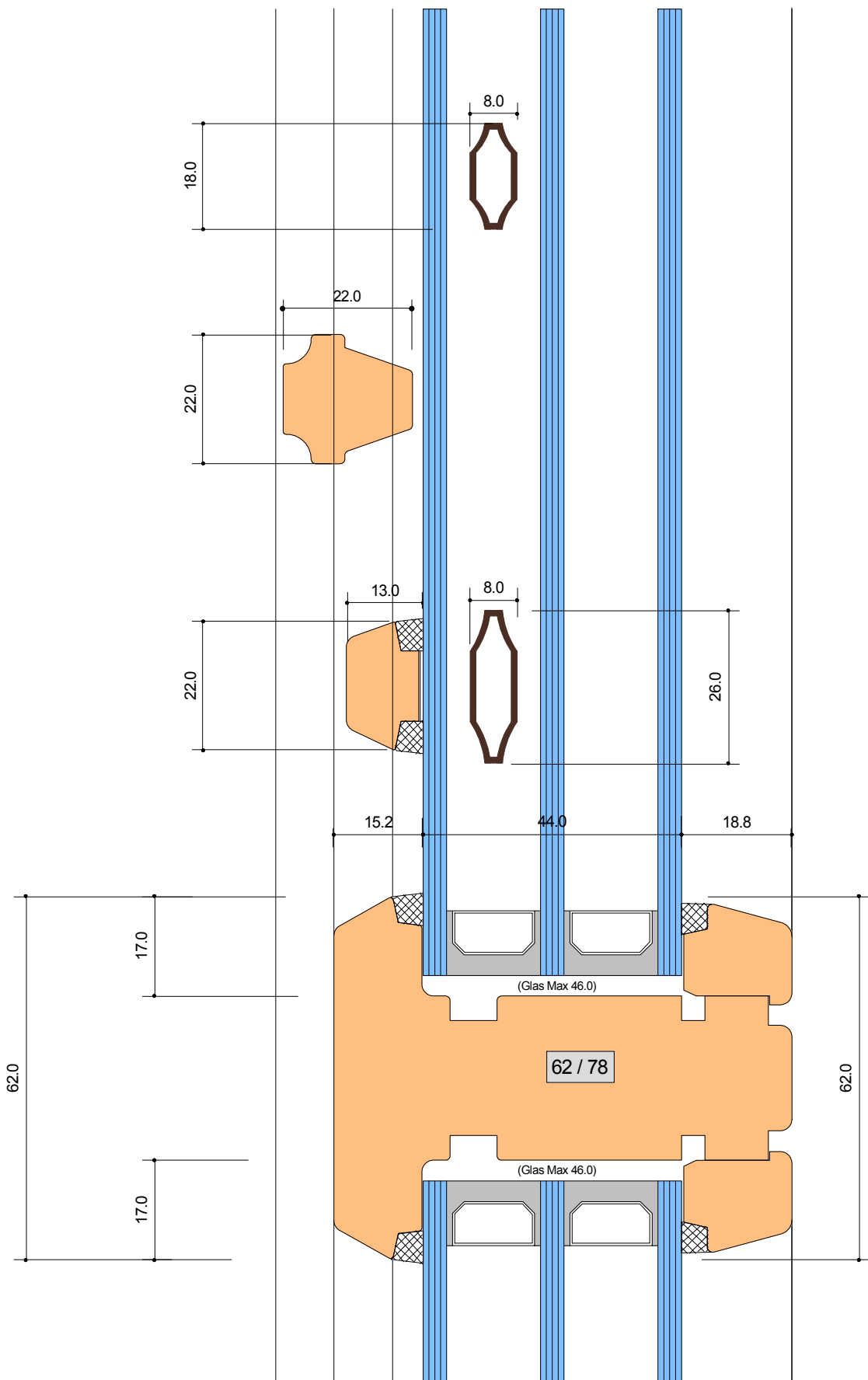

## SYSTEM: H-2 67-78

Sprossen glastrennend 62 mm  
 Vorgesetzte Holz-Spr. 22 +Zw.Glas Sprosse 26  
 Vorgesetzte Klipp-Holz Spr. 22  
 Zwischenglas -Sprosse 18 mm

Detail-Nr :	H - 2	D=601
-------------	-------	-------



Von Euw Fenster AG  
 Schoosstrasse 2  
 6418 Rothenthurm

Tel 041 839 80 50  
 Fax 041 839 80 60  
 mail info@voneuw.ch

Ersteller: Adi von Euw  
 Datum: 27.10.15  
 Revidiert:

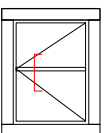



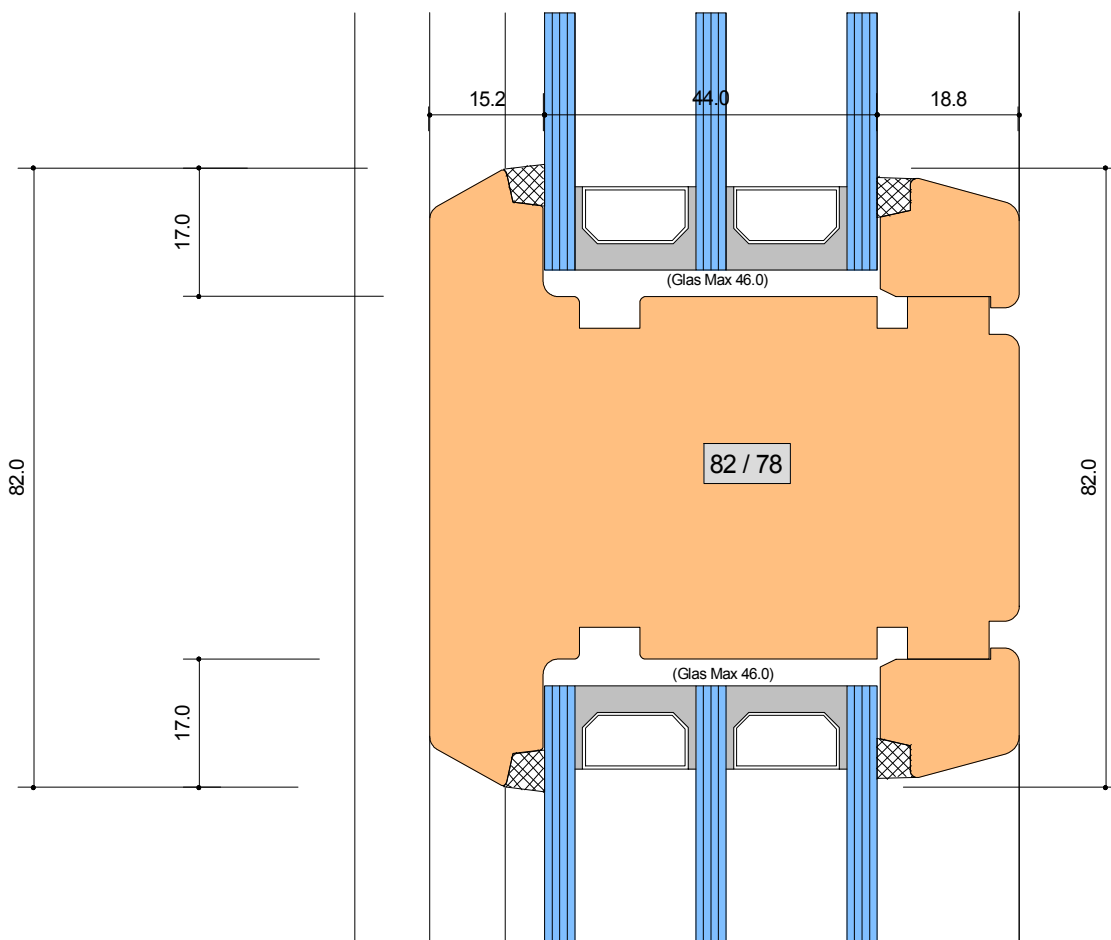

# SYSTEM: H-2 67-78

Sprosse glastrennend 82 mm

Detail-Nr :	H - 2	D=602
-------------	-------	-------

Ersteller: Adi von Euw  
 Datum: 27.10.15  
 Revidiert:



Von Euw Fenster AG  
 Schoosstrasse 2  
 6418 Rothenthurm

Tel 041 839 80 50  
 Fax 041 839 80 60  
 mail info@voneuw.ch

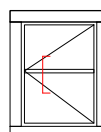

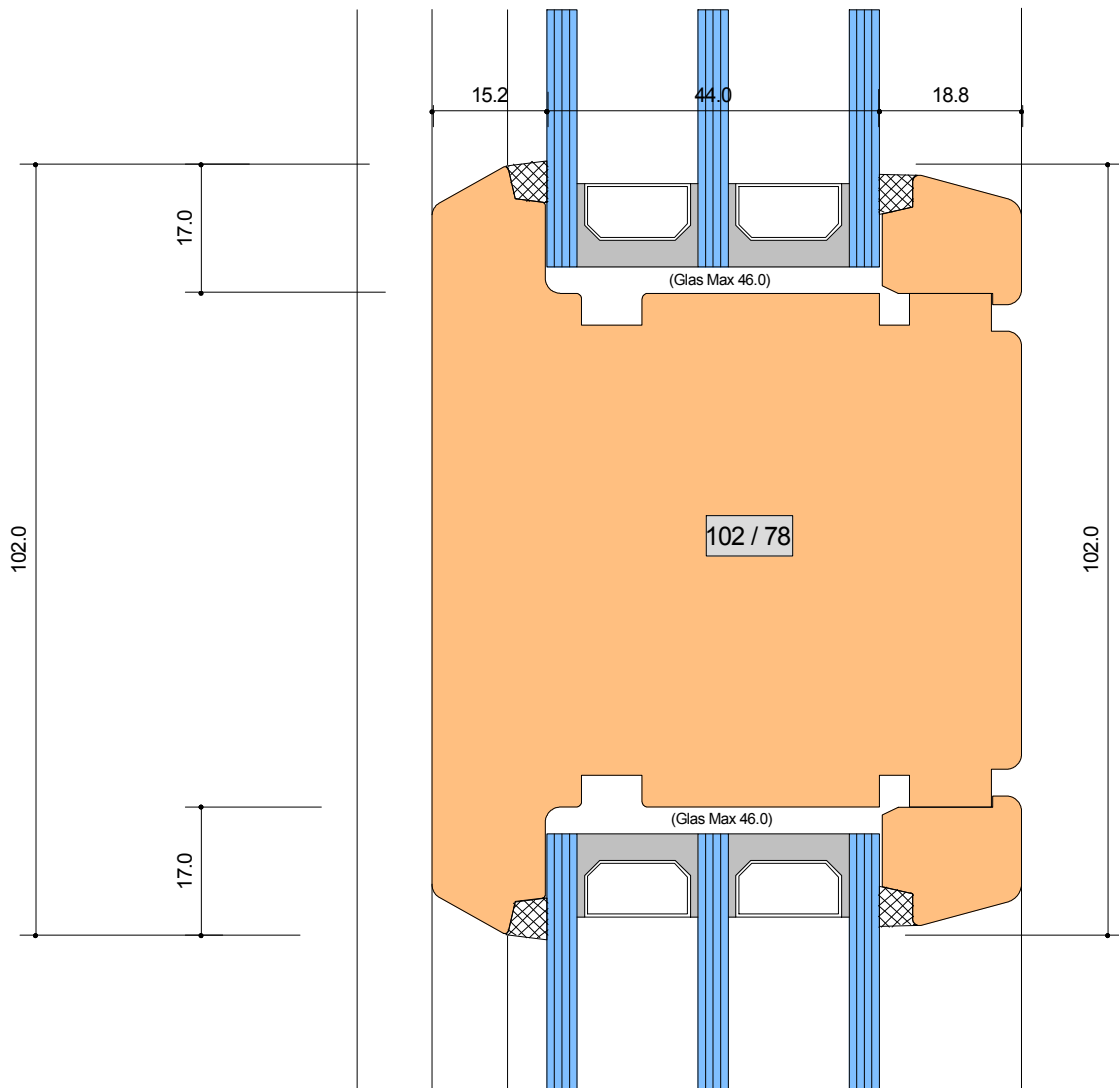

**SYSTEM: H-2 67-78**

Sprosse glastrennend 102 mm

Detail-Nr :	H - 2	D=603
-------------	-------	-------

Ersteller: Adi von Euw  
 Datum: 27.10.15  
 Revidiert:



Von Euw Fenster AG  
 Schoosstrasse 2  
 6418 Rothenthurm

Tel 041 839 80 50  
 Fax 041 839 80 60  
 mail info@voneuw.ch

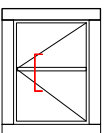

N69202 0.353 g/m1  
 X1-ST 045-008 (roh+eloxiert)  
 Fräsung 30.0 x 5.0 mm  
 Abstand 125/25x250/125

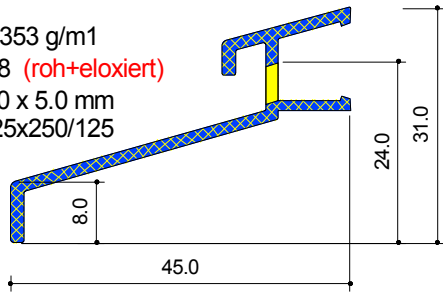

N74777 0.378 g/m1  
 X1-ST 045-013 (roh+eloxiert)  
 Fräsung 30.0 x 5.0 mm  
 Abstand 125/25x250/125

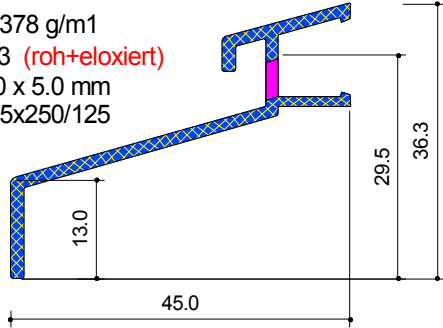

N70586 0.445 g/m1  
 X1-ST 065-008 (roh+eloxiert)  
 Fräsung 30.0 x 5.0 mm  
 Abstand 125/25x250/125

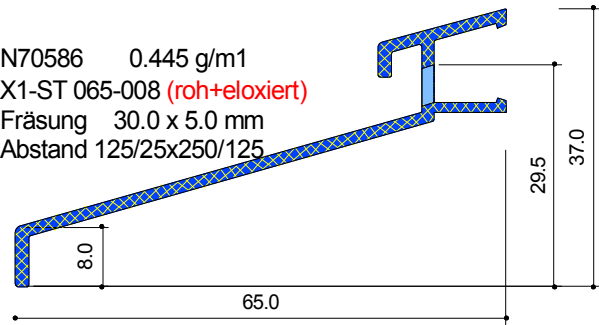

N74260 0.561 g/m1  
 X1-ST 065-030 (eloxiert)  
 Fräsung 30.0 x 5.0 mm  
 Abstand 125/25x250/125

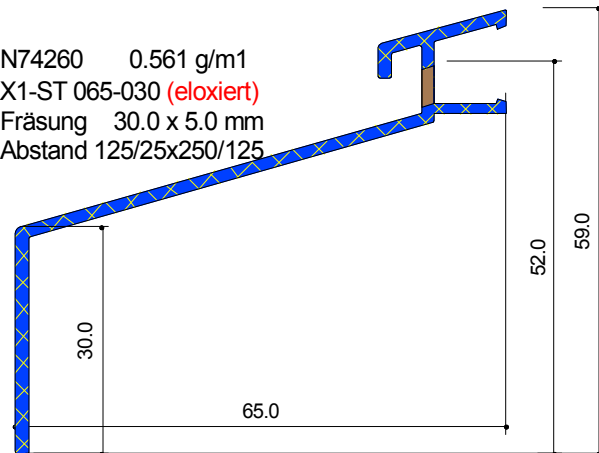

N70584 0.295 g/m1  
 X1-ST 017-021 (eloxiert)  
 Fräsung 30.0 x 5.0 mm  
 Abstand 125/25x250/125

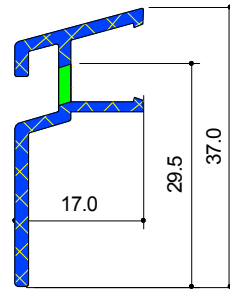

N70585 0.393 g/m1  
 X1-ST 017-041 (eloxiert)  
 Fräsung 30.0 x 5.0 mm  
 Abstand 125/25x250/125

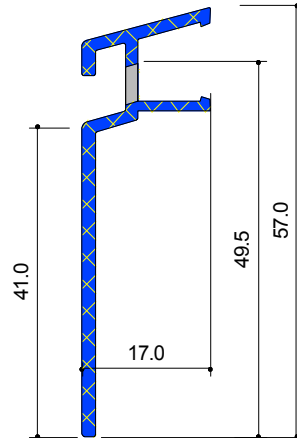

N74261 0.620 g/m1  
 X1-ST 017-084 (eloxiert)  
 Fräsung 30.0 x 5.0 mm  
 Abstand 125/25x250/125

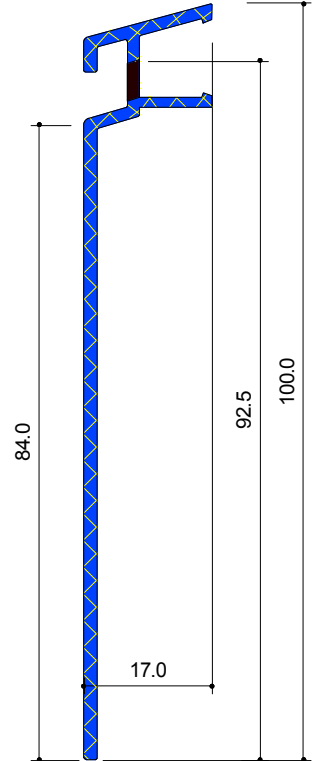

L49108 0.450 g/m1  
 M1-GR 038-18 Roll (roh)  
 Fräsung 30.0 x 5.0 mm  
 Abstand 50/32x200/50

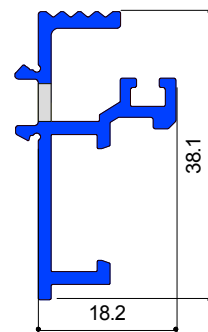

SYSTEM: \*H, L, M, R\*

Steckteil-Profilübersicht



Detail-Nr : A-1 D=100



Von Euw Fenster AG  
 Schoosstrasse 2  
 6418 Rothenthurm

Tel 041 839 80 50  
 Fax 041 839 80 60  
 mail info@voneuw.ch

Ersteller: Adi von Euw  
 Datum: 11.10.19

-  Alu \*roh\* (Lager)
-  Alu \*farblos elox.\* (Lager)
-  Alu \*Roh + farblos elox.\* (Lager)