

Von Euw



Fenster AG
SWISS QUALITY WINDOWS

Holzfenster

System : H-0 59/70

„eco class“

Vermasste Standard-Details

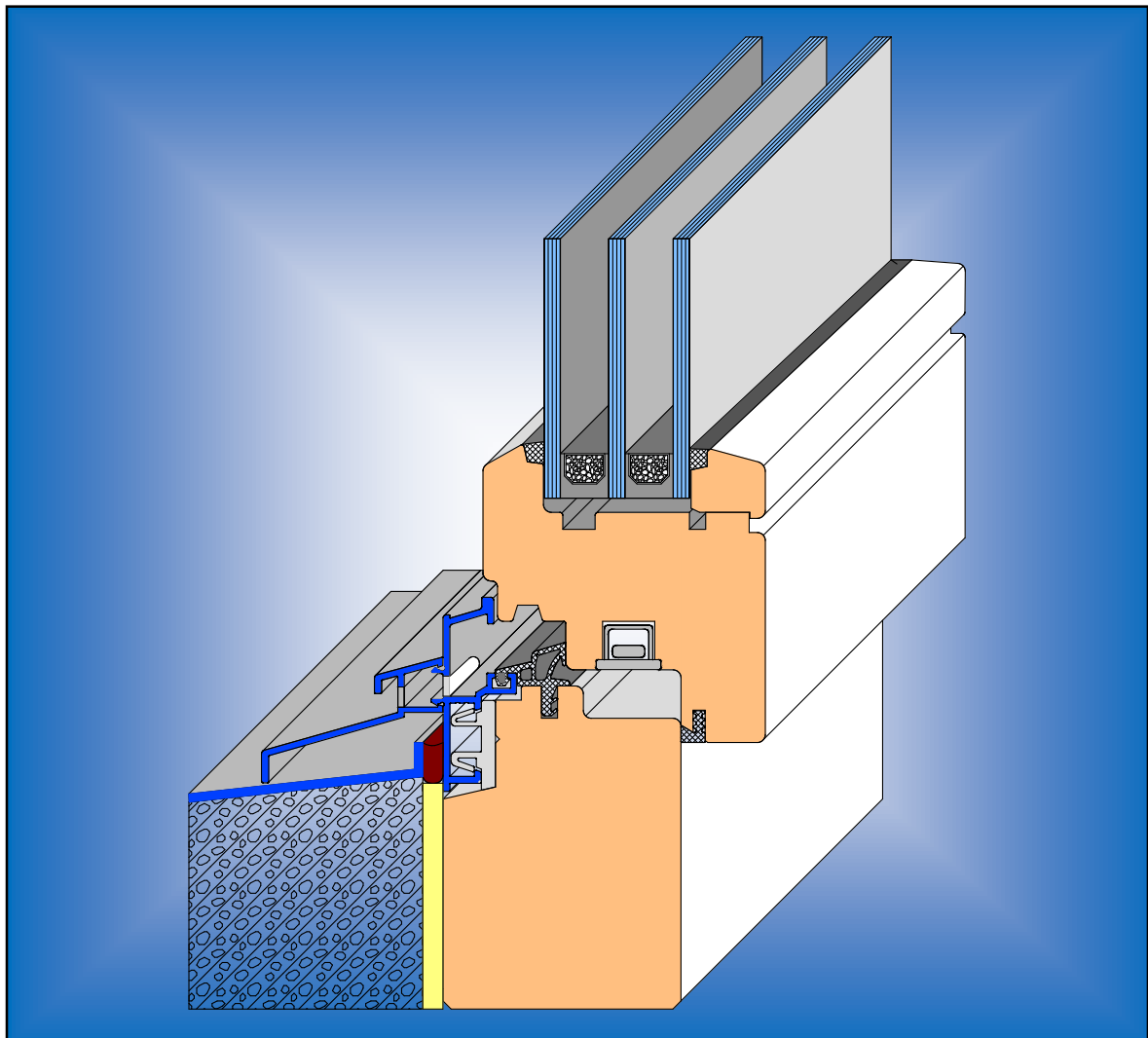

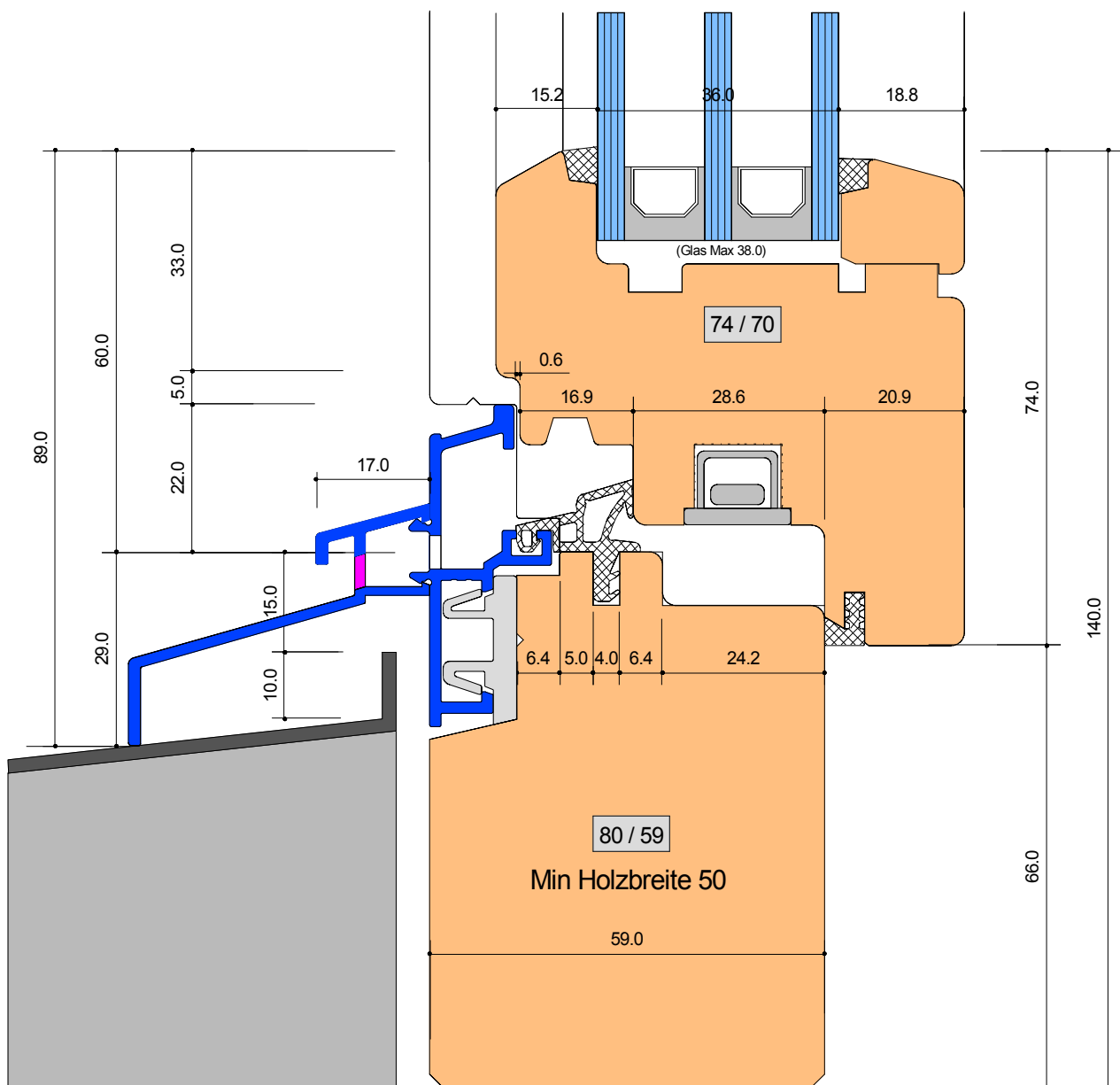

SYSTEM: H-0 59-70

Anschluss unten mit Alu Fensterbank
Wetterschenkel Typ RWS 045-013

Detail-Nr :	H - 0	D=001
-------------	-------	-------



Von Euw Fenster AG
Schoosstrasse 2
6418 Rothenthurm

Tel 041 839 80 50
Fax 041 839 80 60
mail info@voneuw.ch

Ersteller: Adi von Euw
Datum: 16.06.14
Revidiert:

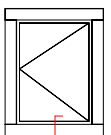

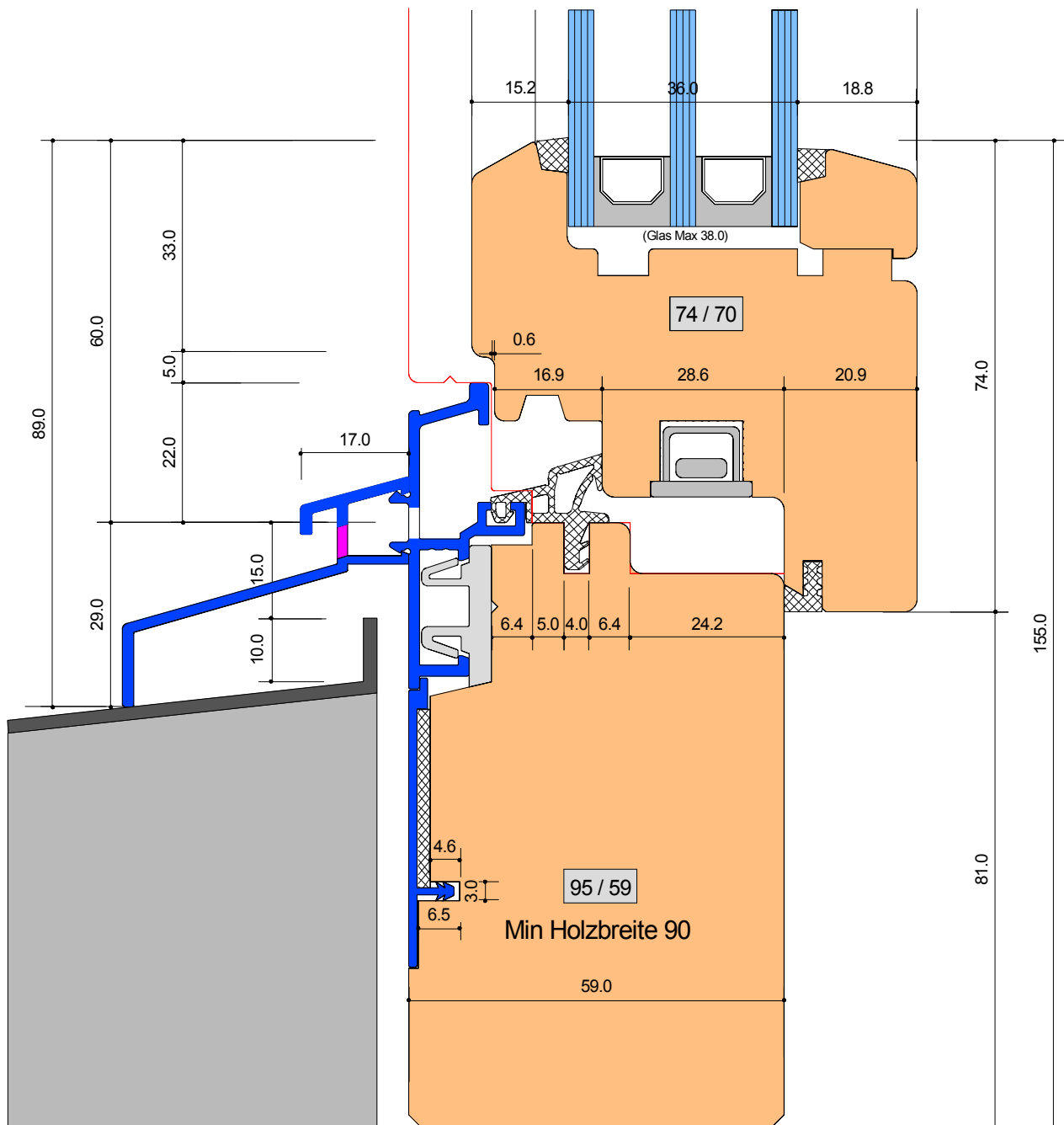

SYSTEM: H-0 59-70

Anschluss unten mit Alu Fensterbank
 Wetterschenkel Typ RWS 045-013
 mit Zusatzprofil für Abklebung bauseits

Detail-Nr :	H - 0	D=001Z
-------------	-------	--------



Von Euw Fenster AG
 Schoosstrasse 2
 6418 Rothenthurm

Tel 041 839 80 50
 Fax 041 839 80 60
 mail info@voneuw.ch

Ersteller: Adi von Euw
 Datum: 16.06.14
 Revidiert:

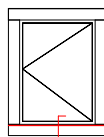

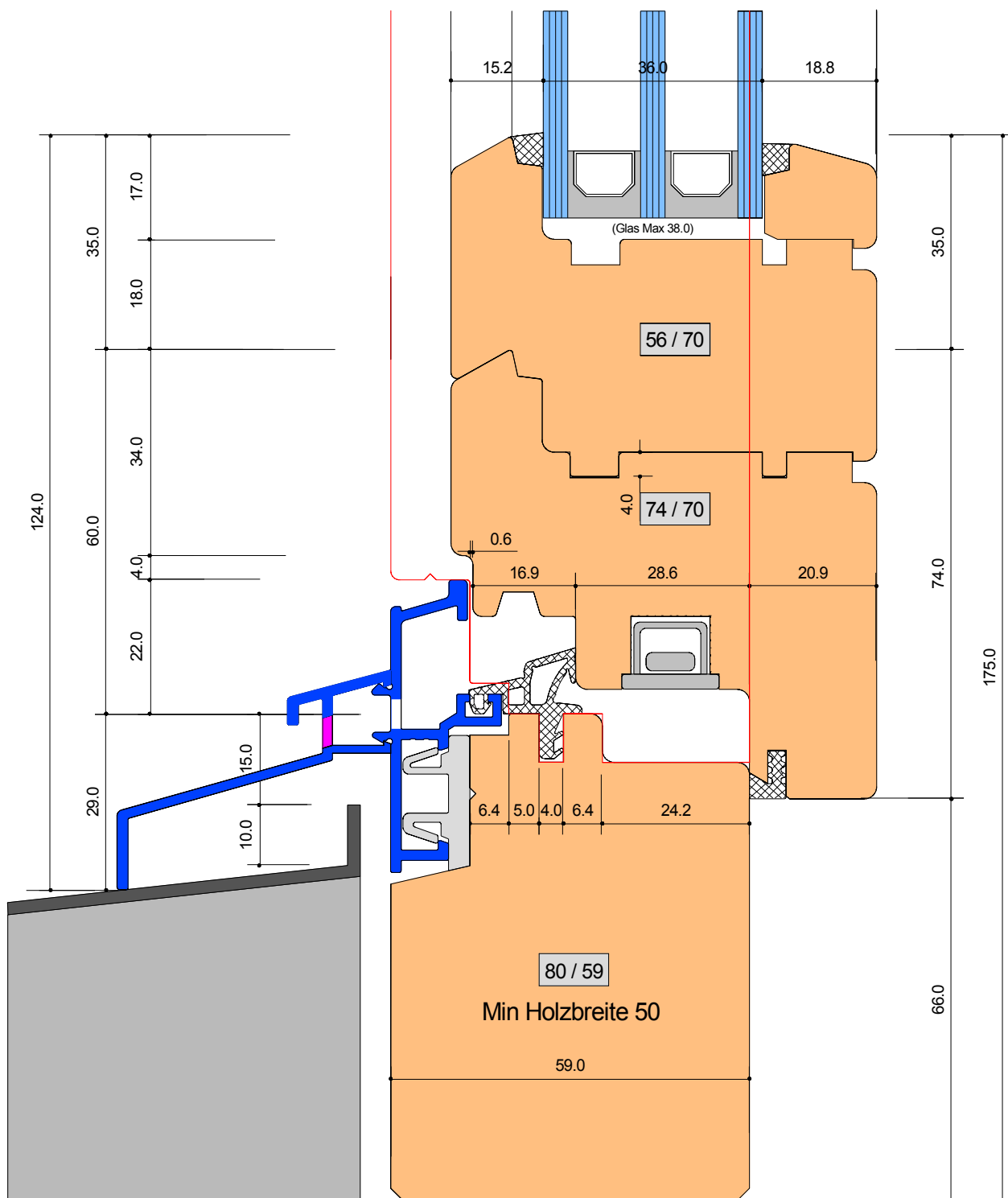

SYSTEM: H-0 59-70

Anschluss unten BT mit Einl 109 mm breit
Wetterschenkel Typ RWS 045-013

Detail-Nr :	H - 0	D=005
-------------	-------	-------



Von Euw Fenster AG
Schoosstrasse 2
6418 Rothenthurm

Tel 041 839 80 50
Fax 041 839 80 60
mail info@voneuw.ch

Ersteller: Adi von Euw
Datum: 16.06.14
Revidiert:

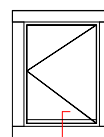

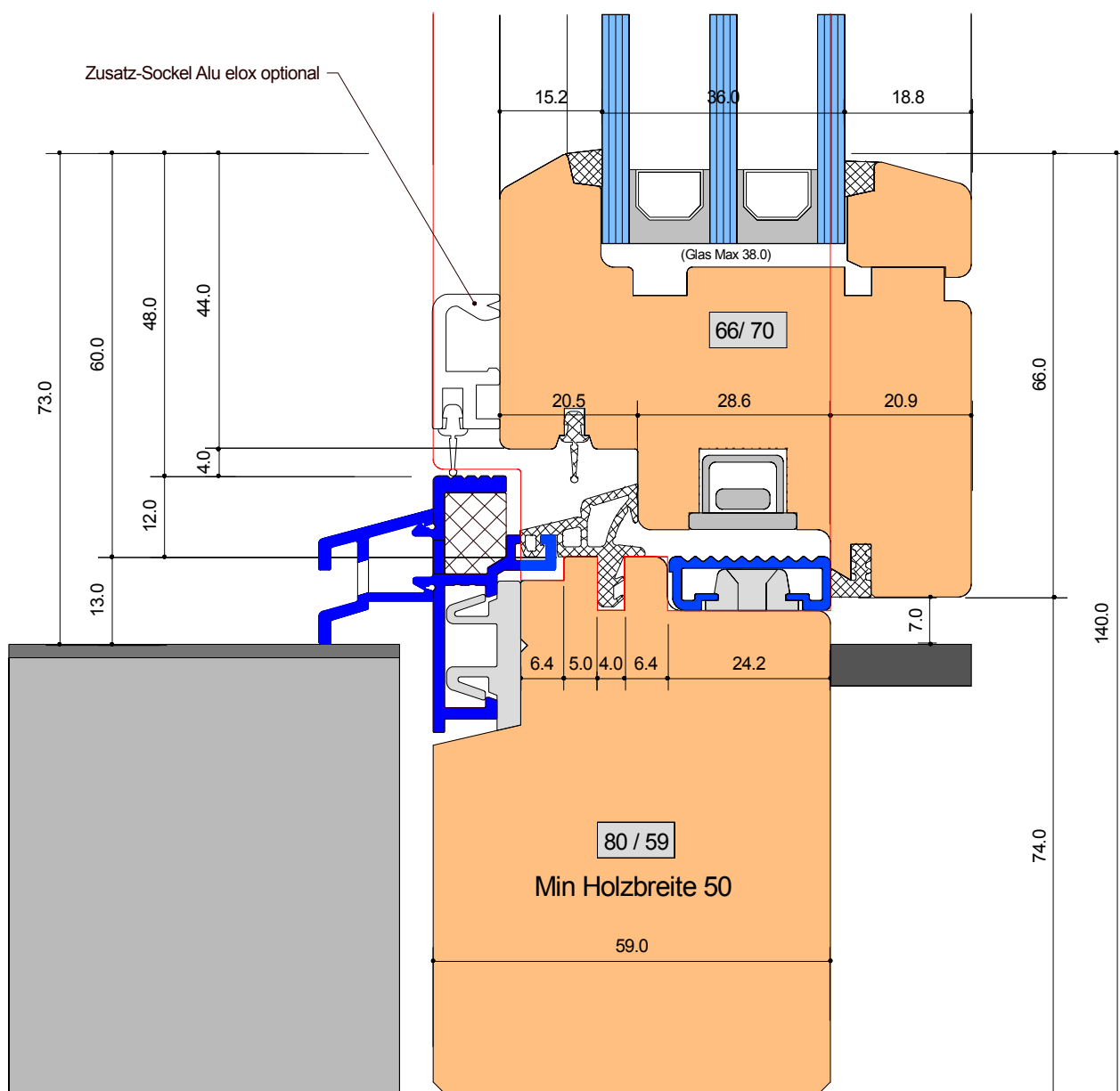

SYSTEM: H-0 59-70

Anschluss unten Rollstuhlgängig BT 62 (70 mm)
 Grundprofil M1-GR 038-18 Roll / Steckteil Variabel

Detail-Nr :	H - 0	D=021
-------------	-------	-------

Ersteller: Adi von Euw
 Datum: 16.06.14
 Revidiert: 09.10.19



Von Euw Fenster AG
 Schoosstrasse 2
 6418 Rothenthurm

Tel 041 839 80 50
 Fax 041 839 80 60
 mail info@voneuw.ch

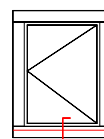

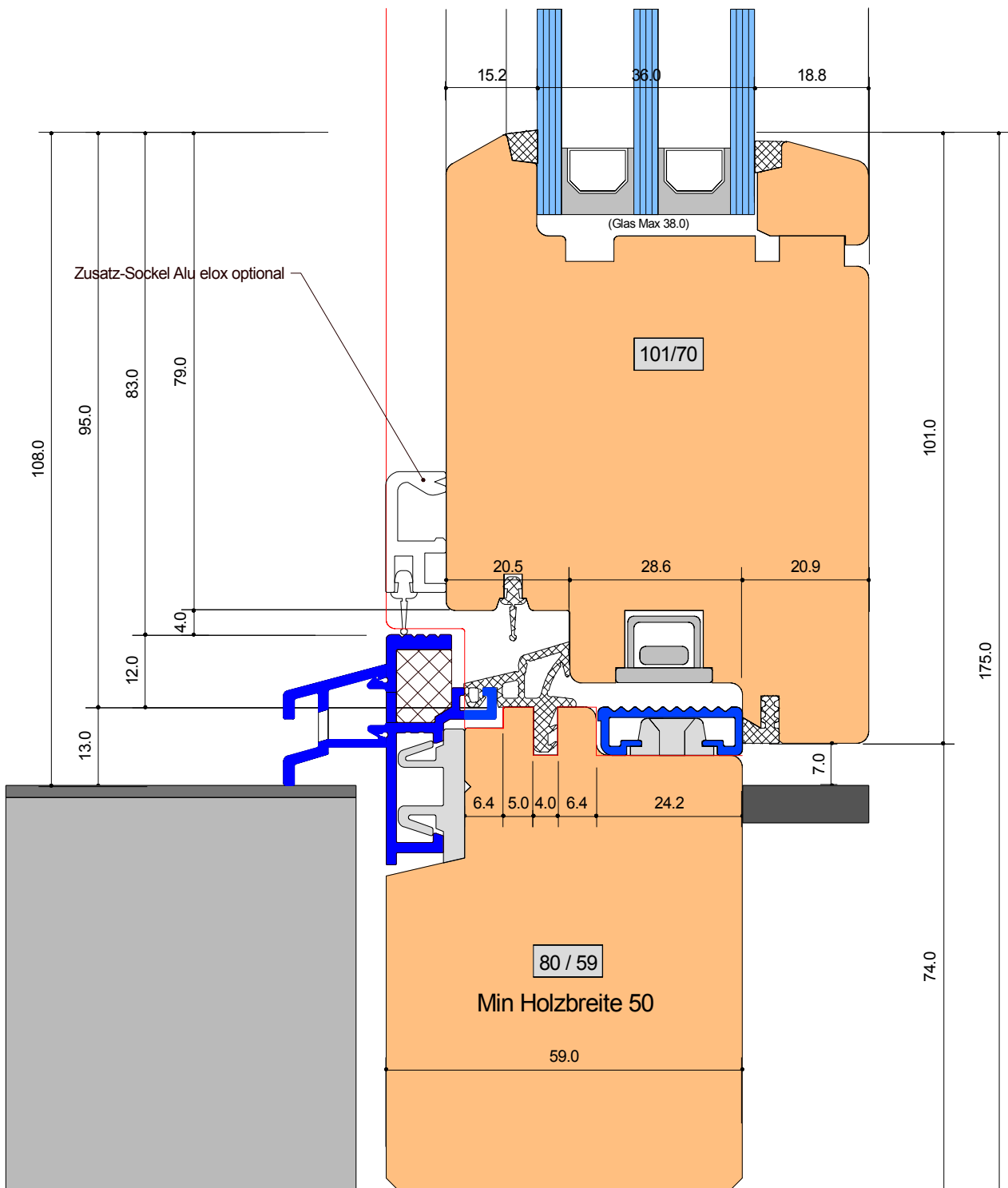

SYSTEM: H-0 59-70

Anschluss unten Rollstuhlgängig BT 101 mm
 Grundprofil M1-GR 038-18 Roll / Steckteil Variabel

Detail-Nr :	H - 0	D=022
-------------	-------	-------



Von Euw Fenster AG
 Schoosstrasse 2
 6418 Rothenthurm

Tel 041 839 80 50
 Fax 041 839 80 60
 mail info@voneuw.ch

Ersteller: Adi von Euw
 Datum: 16.06.14
 Revidiert: 09.10.19

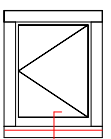

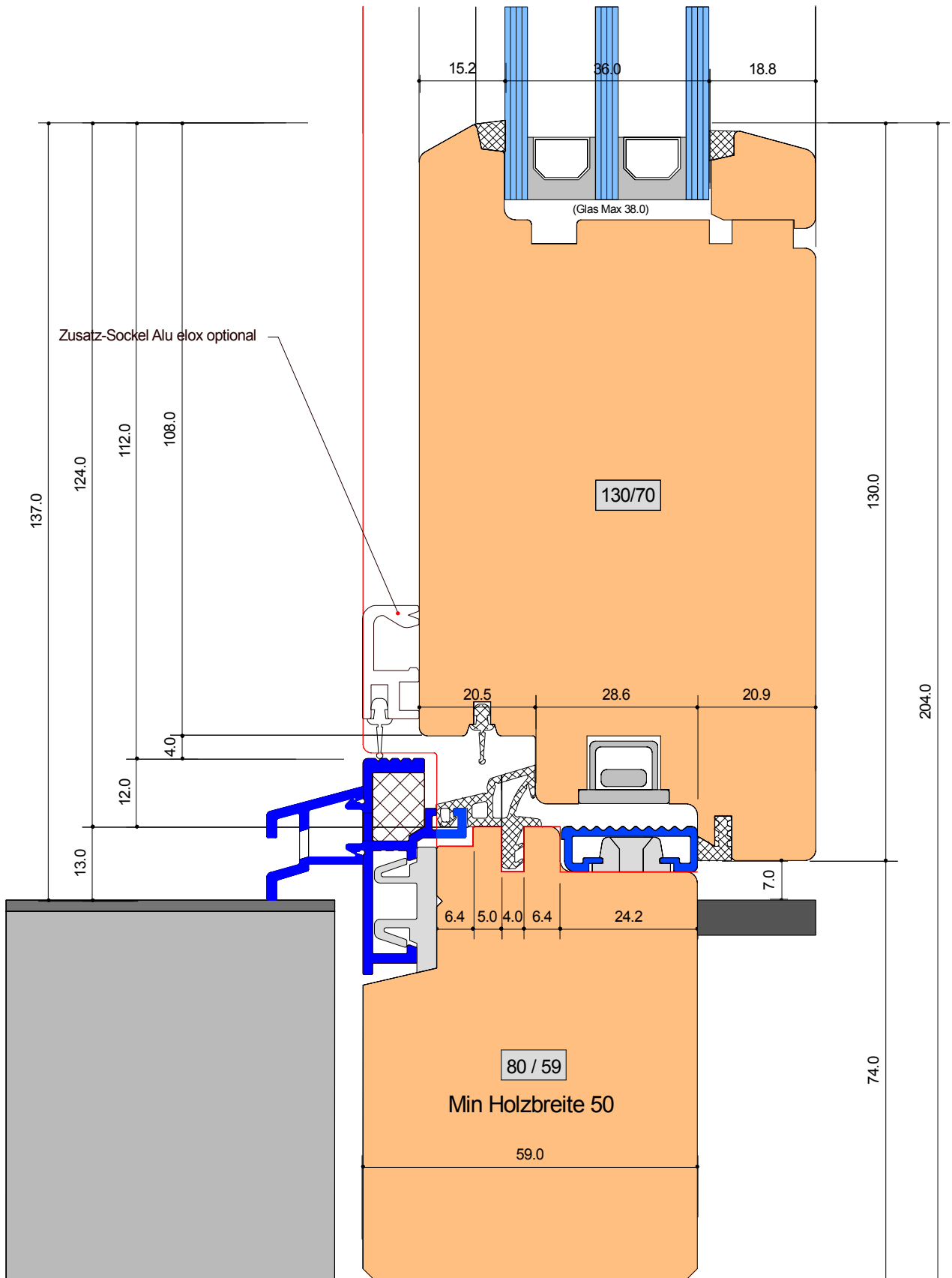

SYSTEM: H-0 59-70

Anschluss unten Rollstuhlgängig BT 130 mm
Grundprofil M1-GR 038-18 Roll / Steckteil Variabel

Detail-Nr :	H - 0	D=023
-------------	-------	-------



Von Euw Fenster AG
Schoosstrasse 2
6418 Rothenthurm

Tel 041 839 80 50
Fax 041 839 80 60
mail info@voneuw.ch

Ersteller: Adi von Euw
Datum: 16.06.14
Revidiert: 09.10.19

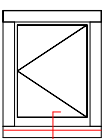

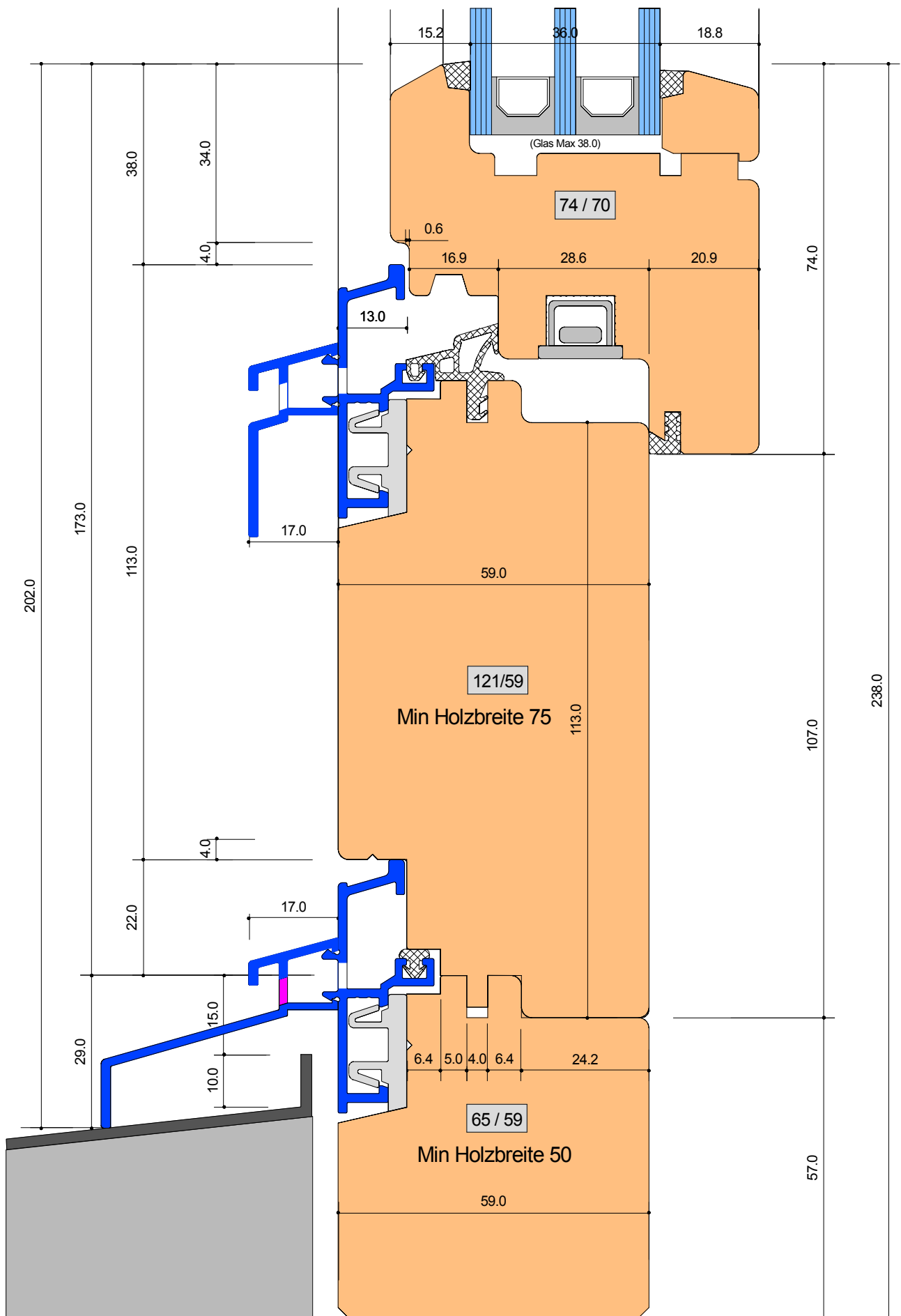

SYSTEM: H-0 59-70

Anschluss unten mit Einleimer
Wetterschenkel Typ RWS 045-013

Detail-Nr :	H - 0	D=031
-------------	-------	-------



Von Euw Fenster AG
Schoosstrasse 2
6418 Rothenthurm

Tel 041 839 80 50
Fax 041 839 80 60
mail info@voneuw.ch

Ersteller: Adi von Euw
Datum: 16.06.14
Revidiert:

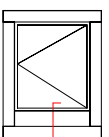

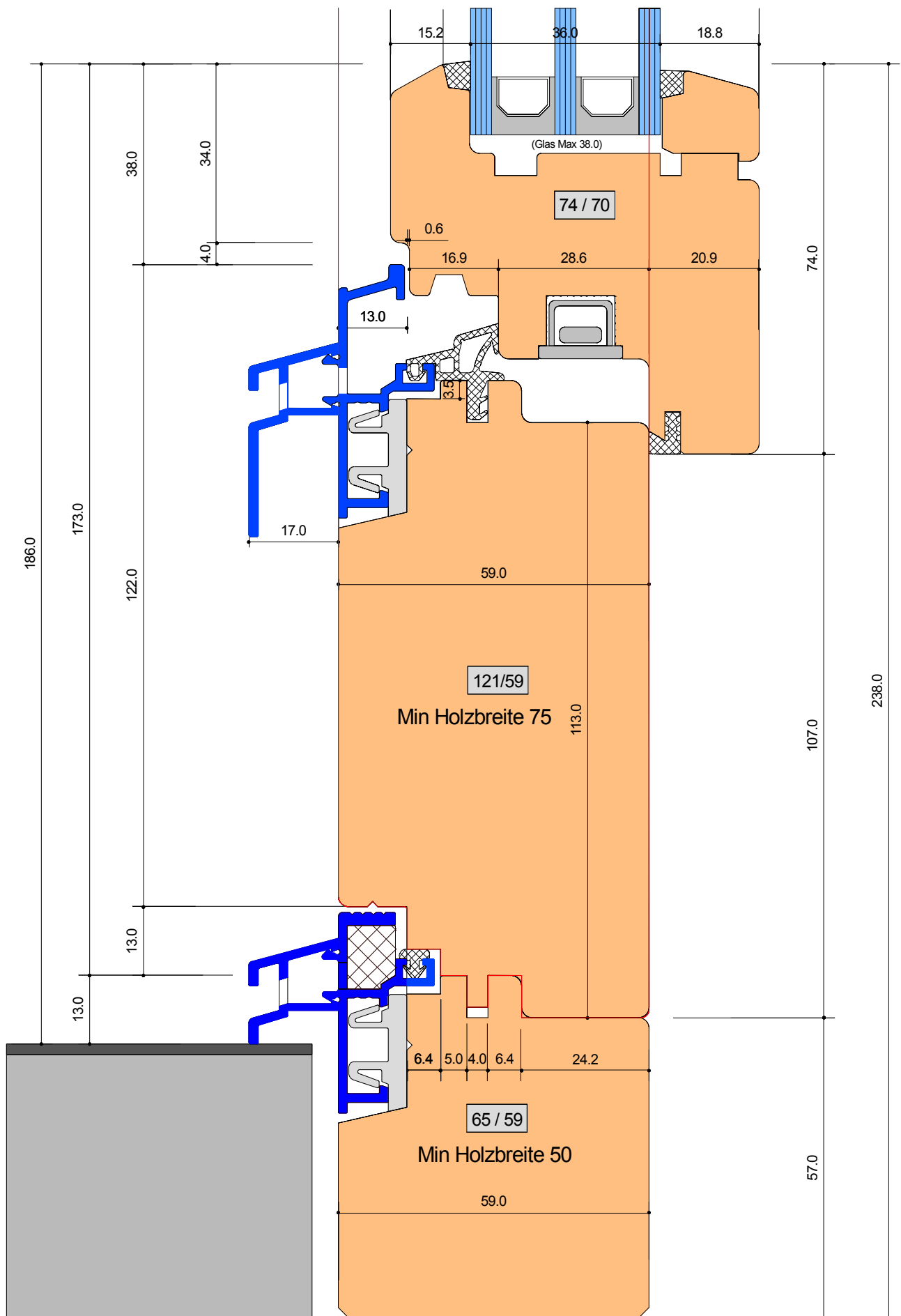

SYSTEM: H-0 59-70

Anschluss unten Rollstuhlgängig mit Einleimer
 Grundprofil M1-GR 038-18 Roll / Steckteil Variabel

Detail-Nr : H - 0 D=035

Ersteller: Adi von Euw
 Datum: 16.06.14
 Revidiert: 10.10.19



Von Euw Fenster AG
 Schoosstrasse 2
 6418 Rothenthurm

Tel 041 839 80 50
 Fax 041 839 80 60
 mail info@voneuw.ch

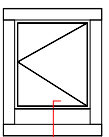

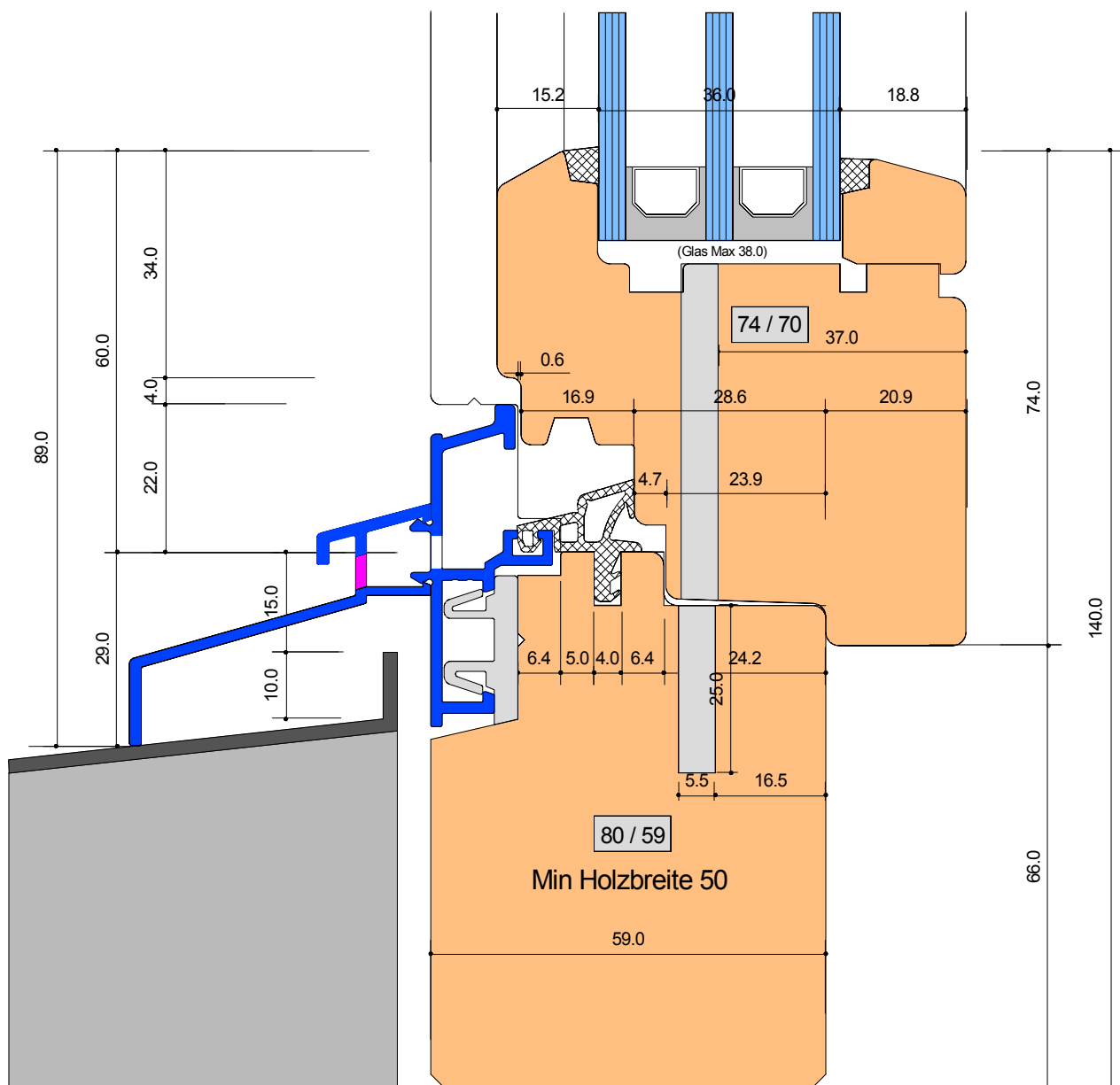

SYSTEM: H-0 59-70

Anschluss unten mit Alu Fensterbank
 Wetterschenkel Typ RWS 045-013
 Fest verglast Flg Fest eingeschraubt Flg 74 mm

Detail-Nr :	H - 0	D=041
-------------	-------	-------



Von Euw Fenster AG
 Schoosstrasse 2
 6418 Rothenthurm

Tel 041 839 80 50
 Fax 041 839 80 60
 mail info@voneuw.ch

Ersteller: Adi von Euw
 Datum: 16.06.14
 Revidiert:

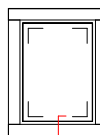

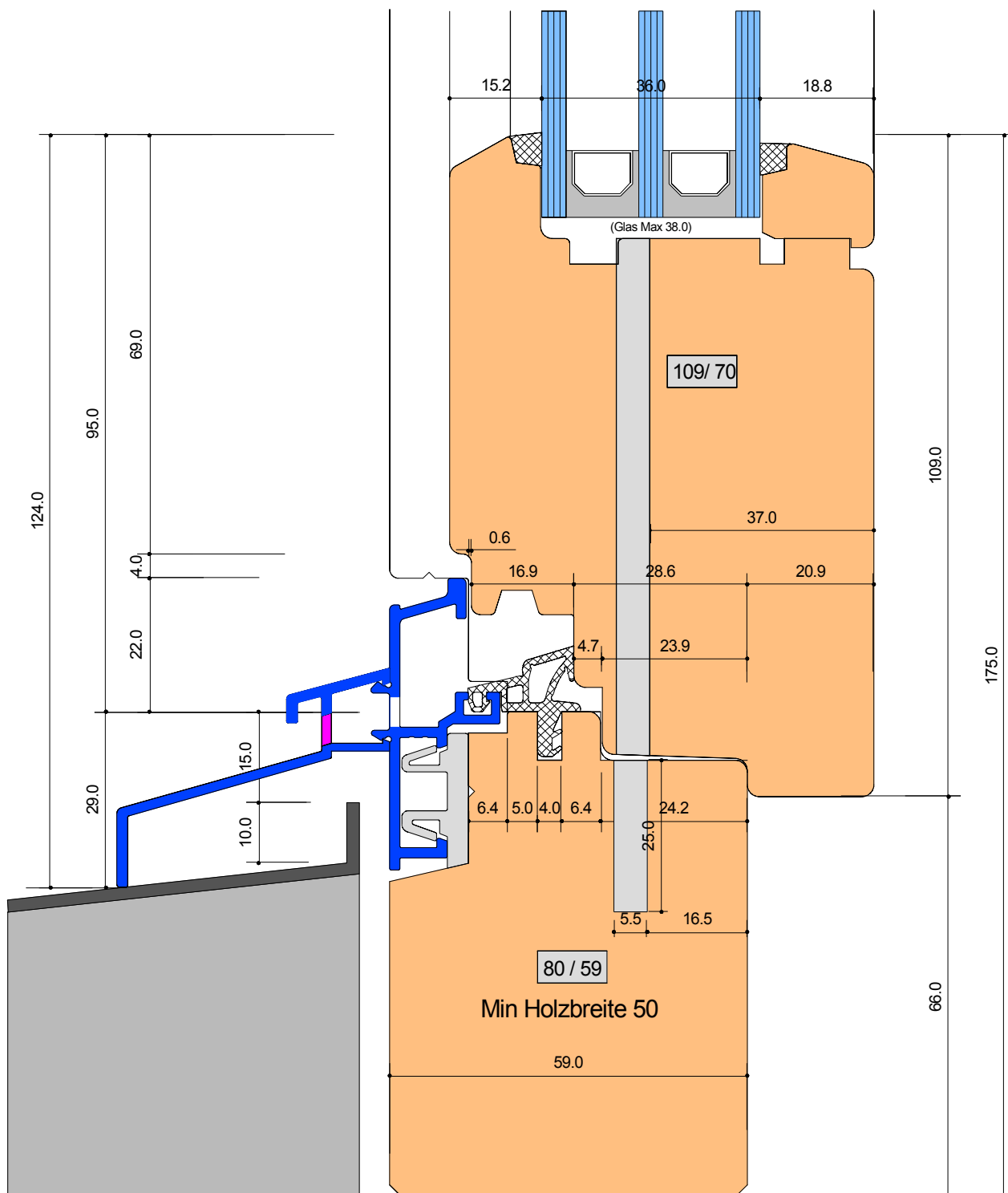

SYSTEM: H-0 59-70

Anschluss unten mit Alu Fensterbank
 Wetterschenkel Typ RWS 045-013
 Fest verglast Flg Fest eingeschraubt Flg 109 mm

Detail-Nr :	H - 0	D=042
-------------	-------	-------



Von Euw Fenster AG
 Schoosstrasse 2
 6418 Rothenthurm

Tel 041 839 80 50
 Fax 041 839 80 60
 mail info@voneuw.ch

Ersteller: Adi von Euw
 Datum: 16.06.14
 Revidiert:

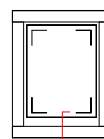

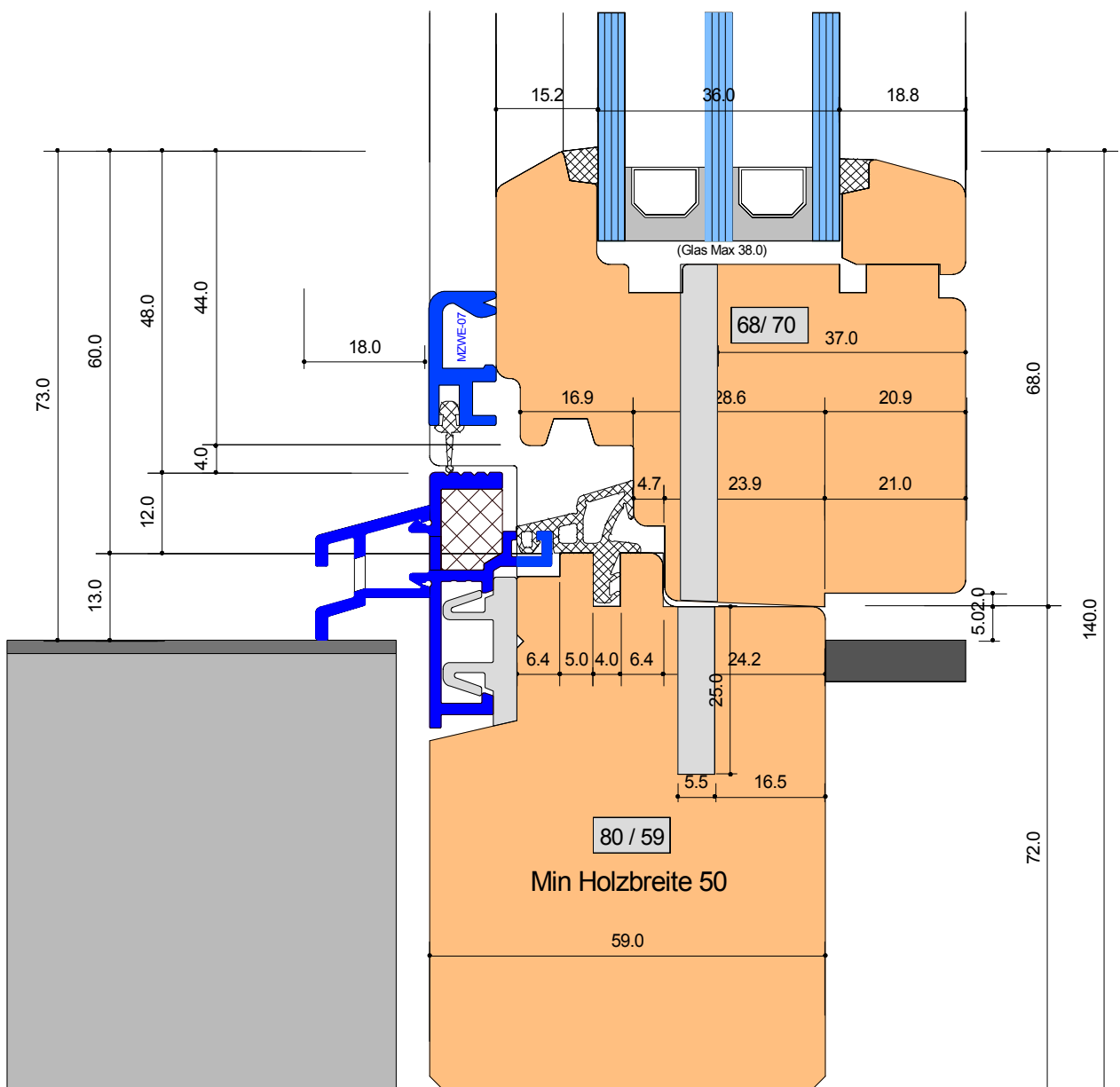

SYSTEM: H-0 59-70

Anschluss unten Rollstuhlgängig BT 62 (70 mm)
 Grundprofil M1-GR 038-18 Roll / Steckteil Variabel
 Fest verglast Roll. Flg 68 mm (-6.0)

Detail-Nr :	H - 0	D=045
-------------	-------	-------



Von Euw Fenster AG
 Schoosstrasse 2
 6418 Rothenthurm

Tel 041 839 80 50
 Fax 041 839 80 60
 mail info@voneuw.ch

Ersteller: Adi von Euw
 Datum: 16.06.14
 Revidiert: 09.10.19

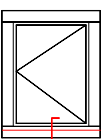

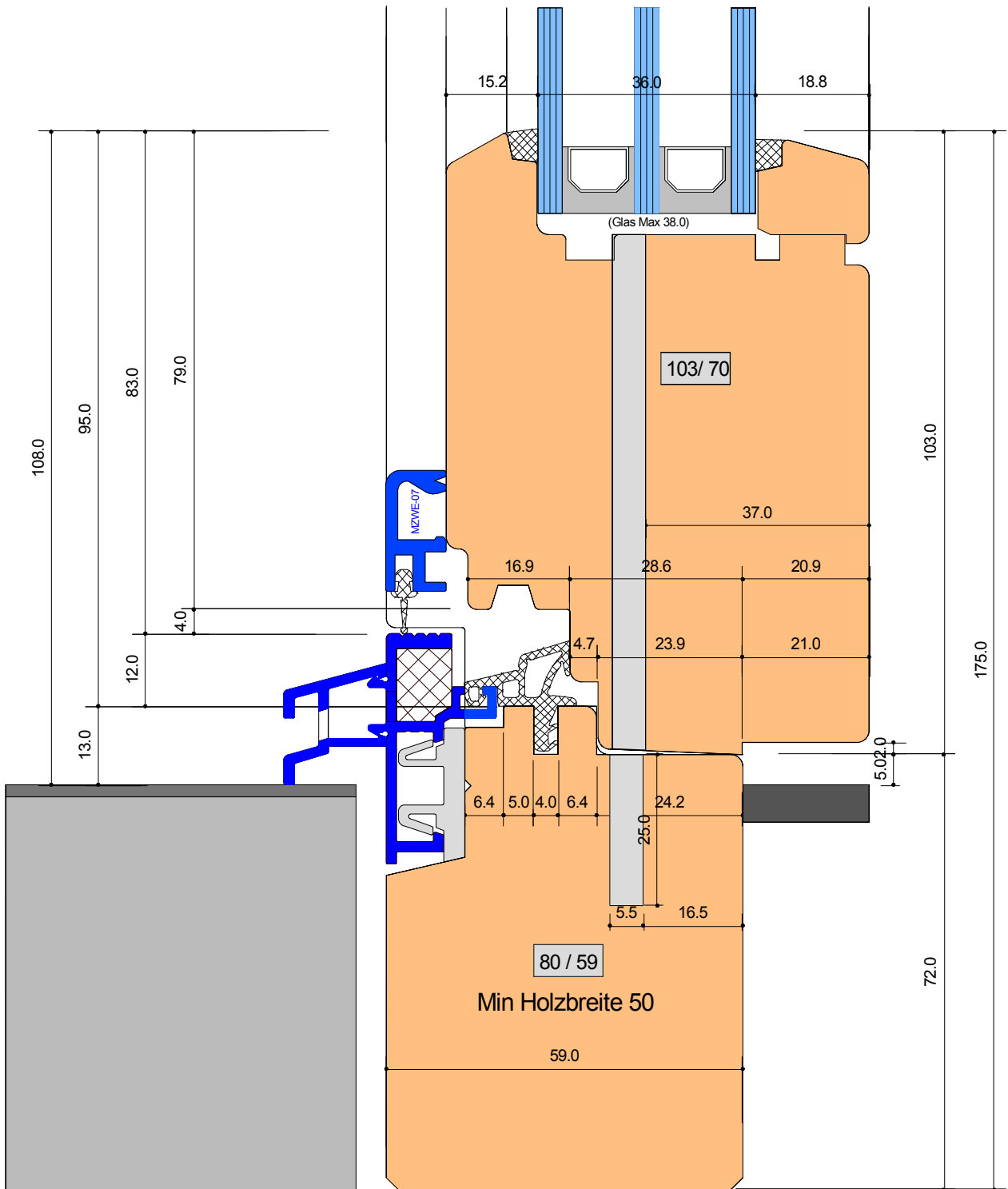

SYSTEM: H-0 59-70

Anschluss unten Rollstuhlgängig BT 62 (70 mm)
 Grundprofil M1-GR 038-18 Roll / Steckteil Variabel
 Fest verglast Roll. Flg 103 mm (-6.0)

Detail-Nr :	H - 0	D=046
-------------	-------	-------



Von Euw Fenster AG
 Schoosstrasse 2
 6418 Rothenthurm

Tel 041 839 80 50
 Fax 041 839 80 60
 mail info@voneuw.ch

Ersteller: Adi von Euw
 Datum: 16.06.14
 Revidiert: 09.10.19

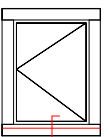

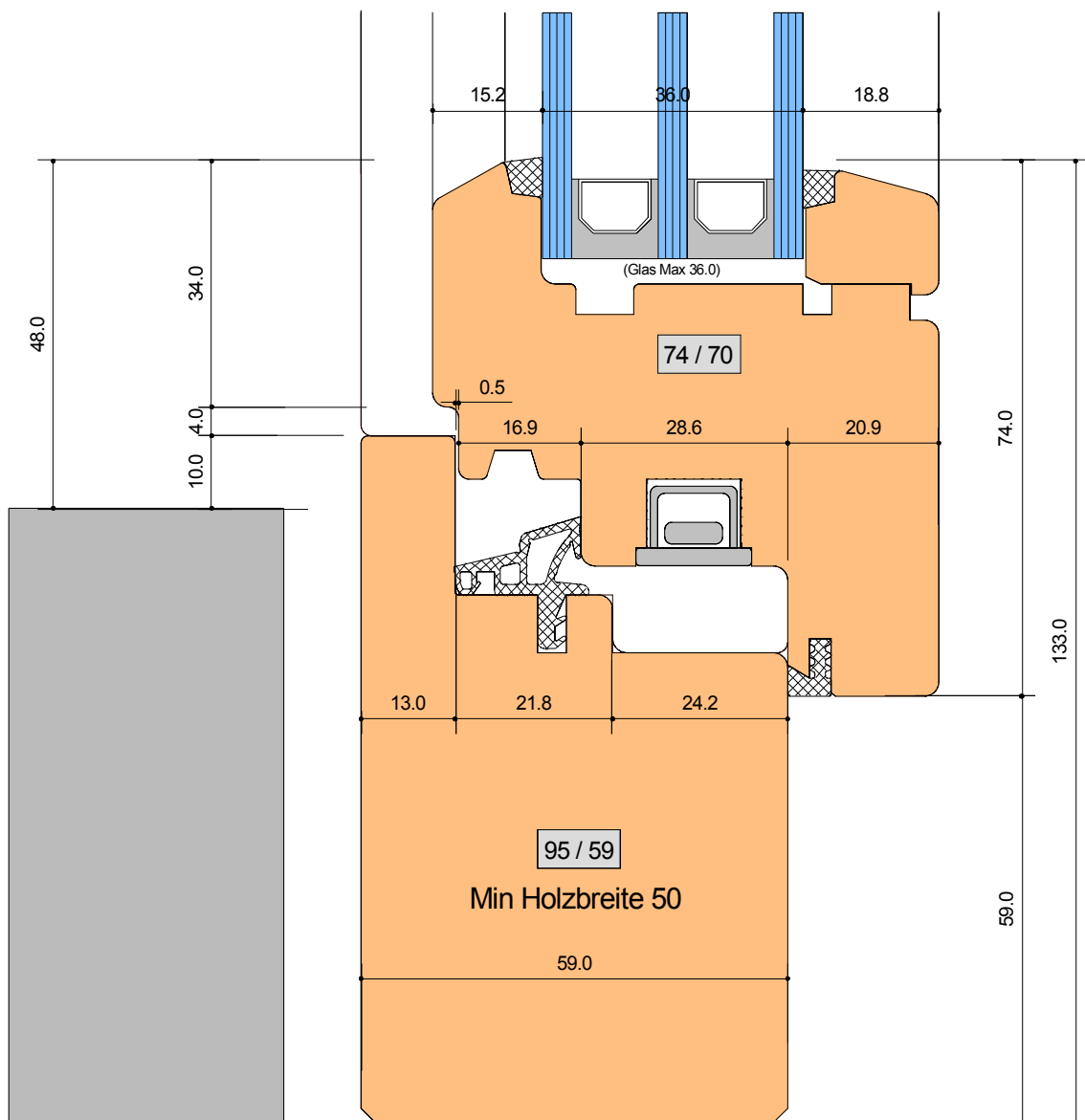

SYSTEM: H-0 59-70

Anschluss seitlich Standart Fig 74

Detail-Nr :	H - 0	D=201
-------------	-------	-------

Ersteller: Adi von Euw
 Datum: 16.06.14
 Revidiert:



Von Euw Fenster AG
 Schoosstrasse 2
 6418 Rothenthurm

Tel 041 839 80 50
 Fax 041 839 80 60
 mail info@voneuw.ch

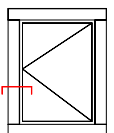

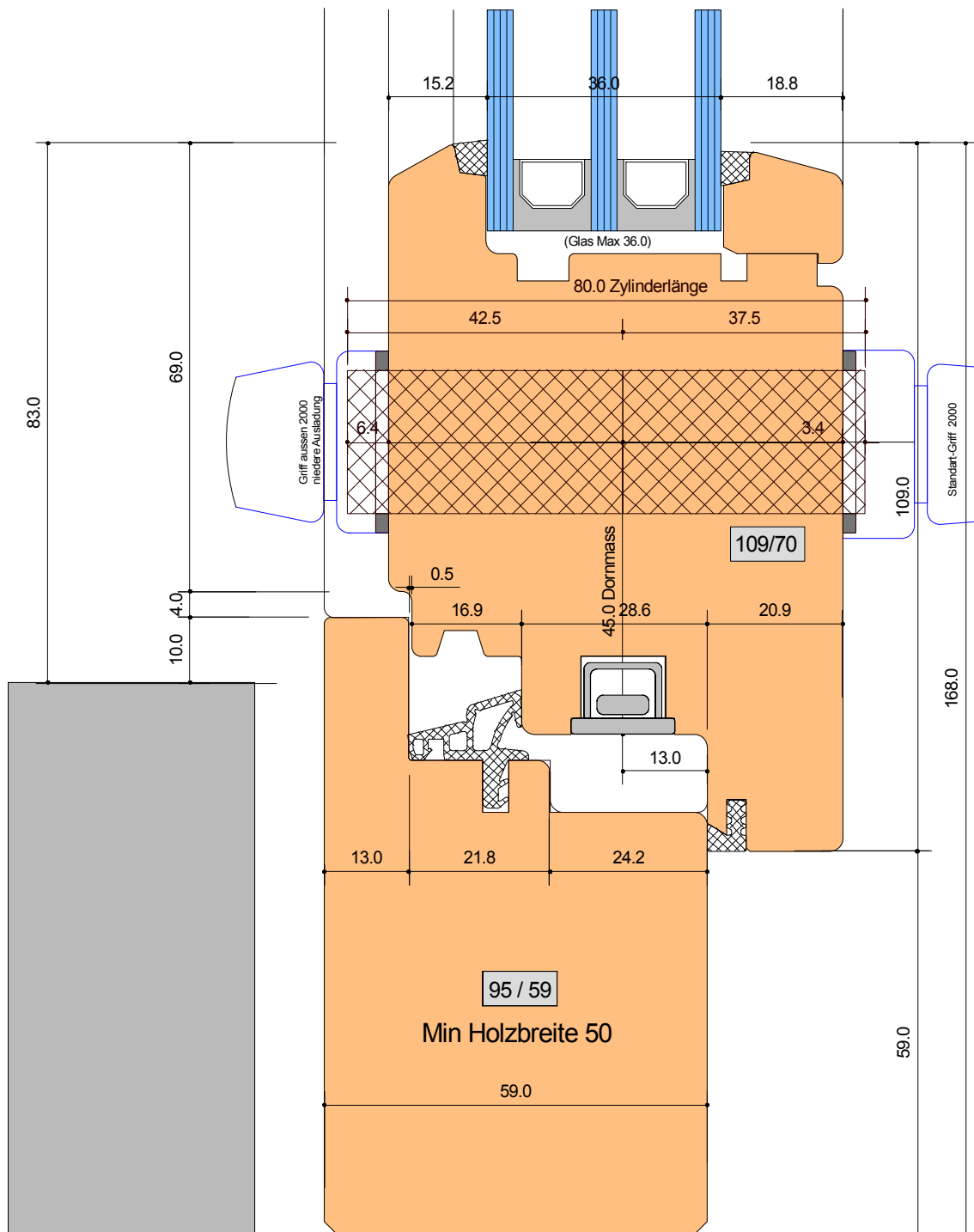

SYSTEM: H-0 59-70

Anschluss seitlich Standart Flg 109 mm
 Verschluss durchg. D=45.0 mm Griff m.Knopf/Schlüssel
 Variante: Verschluss durchg. D=45.0 mm mit Zylinder

Detail-Nr : H - 0 D=205



Von Euw Fenster AG
 Schoosstrasse 2
 6418 Rothenthurm

Tel 041 839 80 50
 Fax 041 839 80 60
 mail info@voneuw.ch

Ersteller: Adi von Euw
 Datum: 16.06.16
 Revidiert:

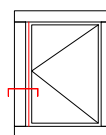

Variante 1
 Schutzschild Glutz
 ES1 5430S mit Zyl.
 Schutzrosette (10-14 mm)

Variante 1
 Innenschild Glutz
 ES1 5435C.2 gerade

Variante 2
 Rund-Schutzrosette Glutz
 ES1 5330.2S-RS mit Schutz-
 Einsatz (7-12 einwärts)

Variante 2
 Rund-Rosette innen Gl
 5330.C mit Grundplatte

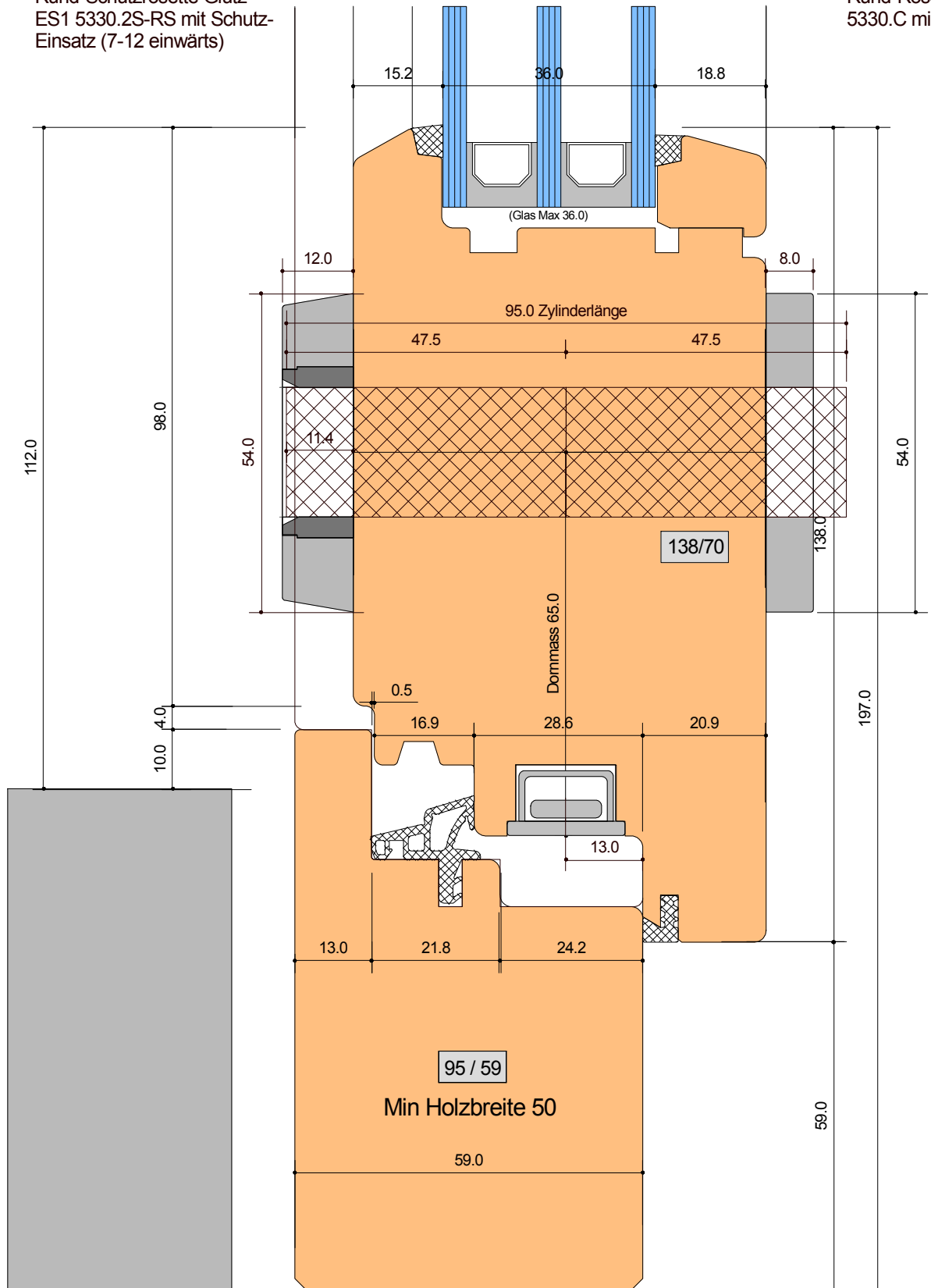

SYSTEM: H-0 59-70

Anschluss seitlich mit Haustürverschluss Flg 138
 mit Haustürverschluss D=65 mm
 mit Sicherheitslangschild Glutz 5430S/5435C.2
 mit Rund-Ros Glutz ES1 5330.2S-RS/5330C

Detail-Nr : H - 0 D=210



Von Euw Fenster AG
 Schoosstrasse 2
 6418 Rothenthurm

Tel 041 839 80 50
 Fax 041 839 80 60
 mail info@voneuw.ch

Ersteller: Adi von Euw
 Datum: 15.06.16
 Revidiert:

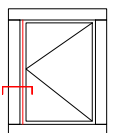

utz
e

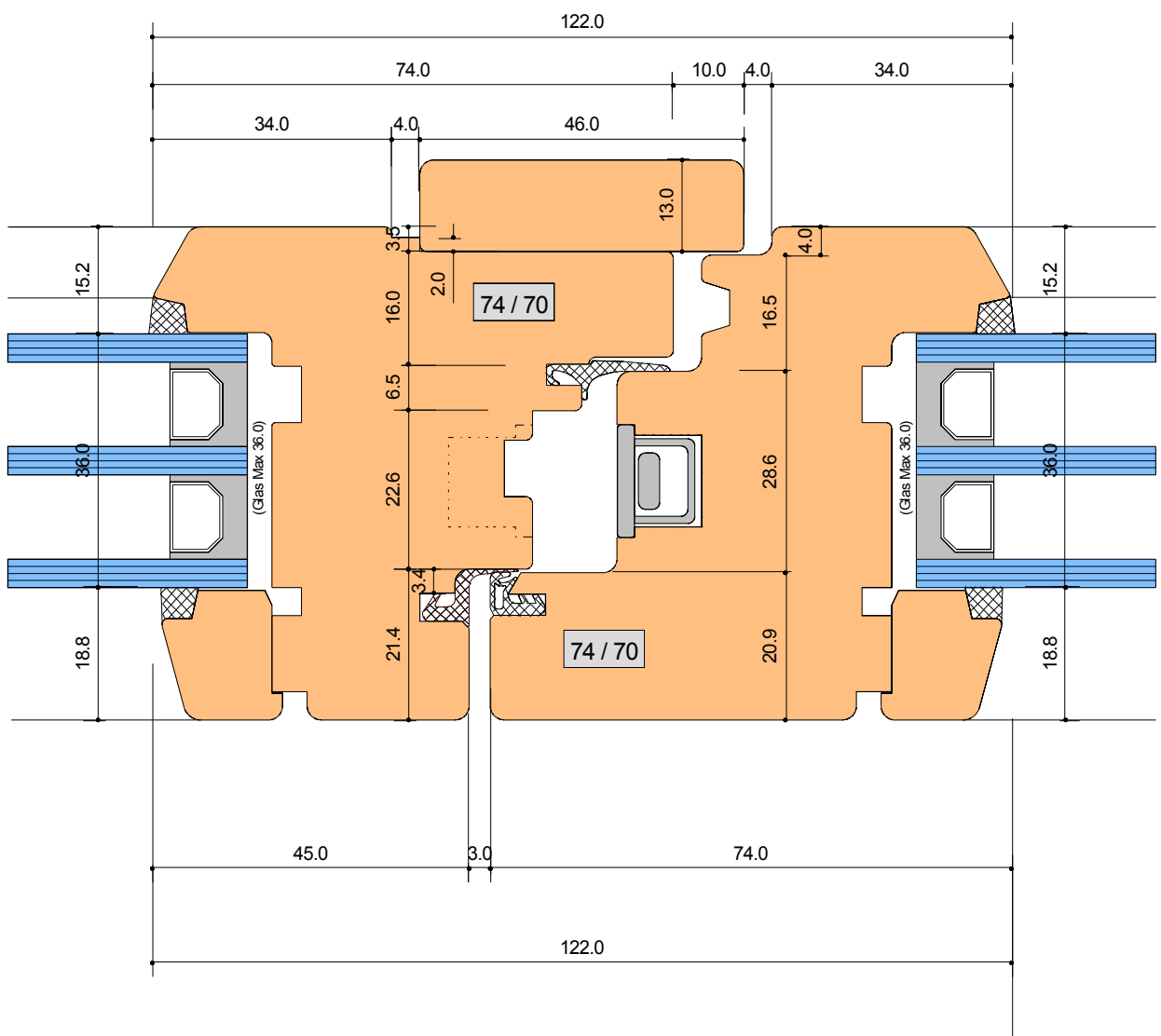

SYSTEM: H-0 59-70

Mittelpartie standard mit 2 x 74 mm Flg

Detail-Nr :	H - 0	D=301
-------------	-------	-------

Ersteller: Adi von Euw
Datum: 16.06.14
Revidiert:



Von Euw Fenster AG
Schoosstrasse 2
6418 Rothenthurm

Tel 041 839 80 50
Fax 041 839 80 60
mail info@voneuw.ch

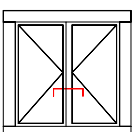

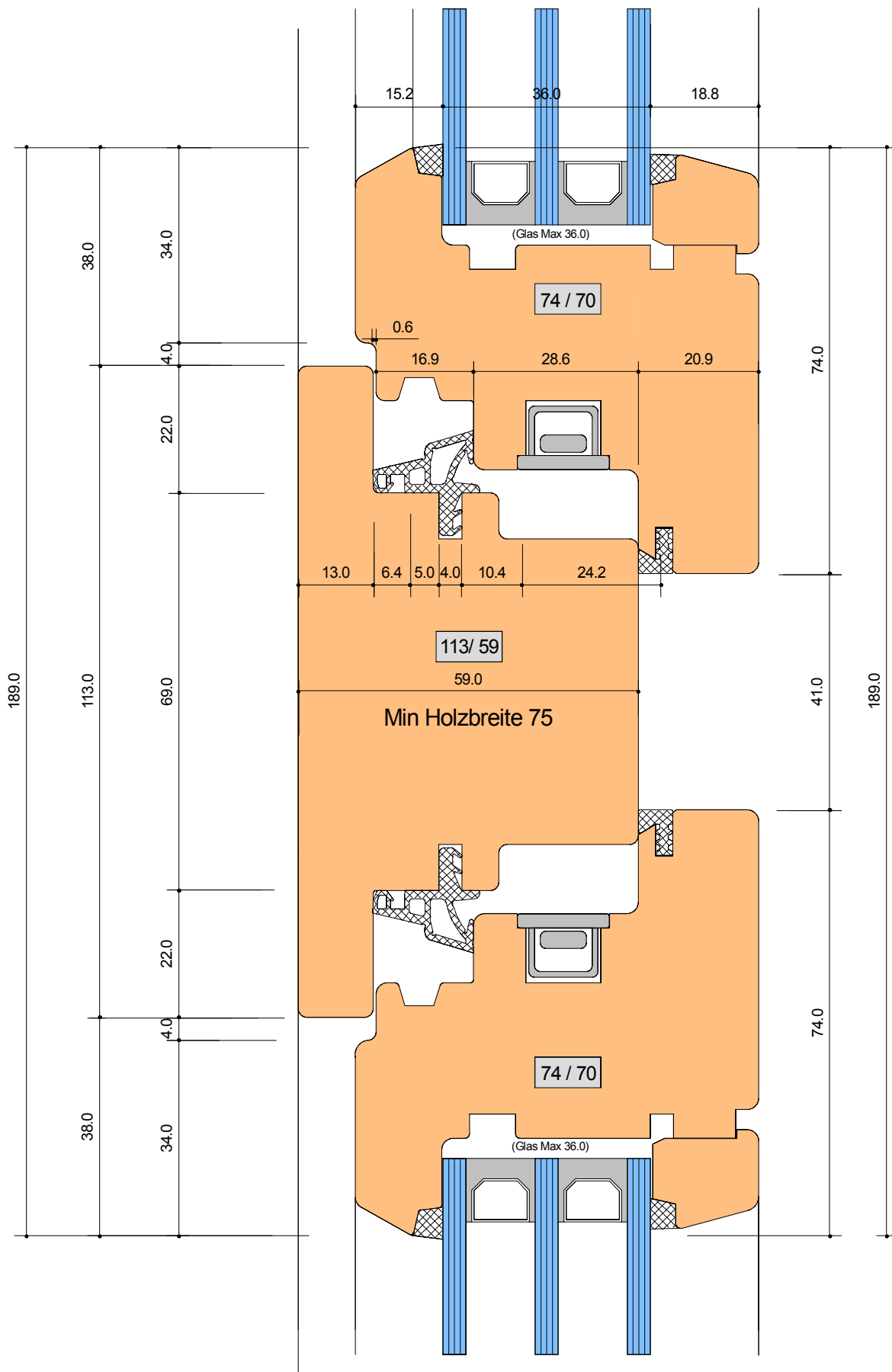

SYSTEM: H-0 59-70

Setzholz 113 mm

Detail-Nr :	H - 0	D=401
-------------	-------	-------

Ersteller: Adi von Euw
 Datum: 16.06.14
 Revidiert:



Von Euw Fenster AG
 Schoosstrasse 2
 6418 Rothenthurm

Tel 041 839 80 50
 Fax 041 839 80 60
 mail info@voneuw.ch

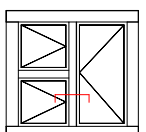

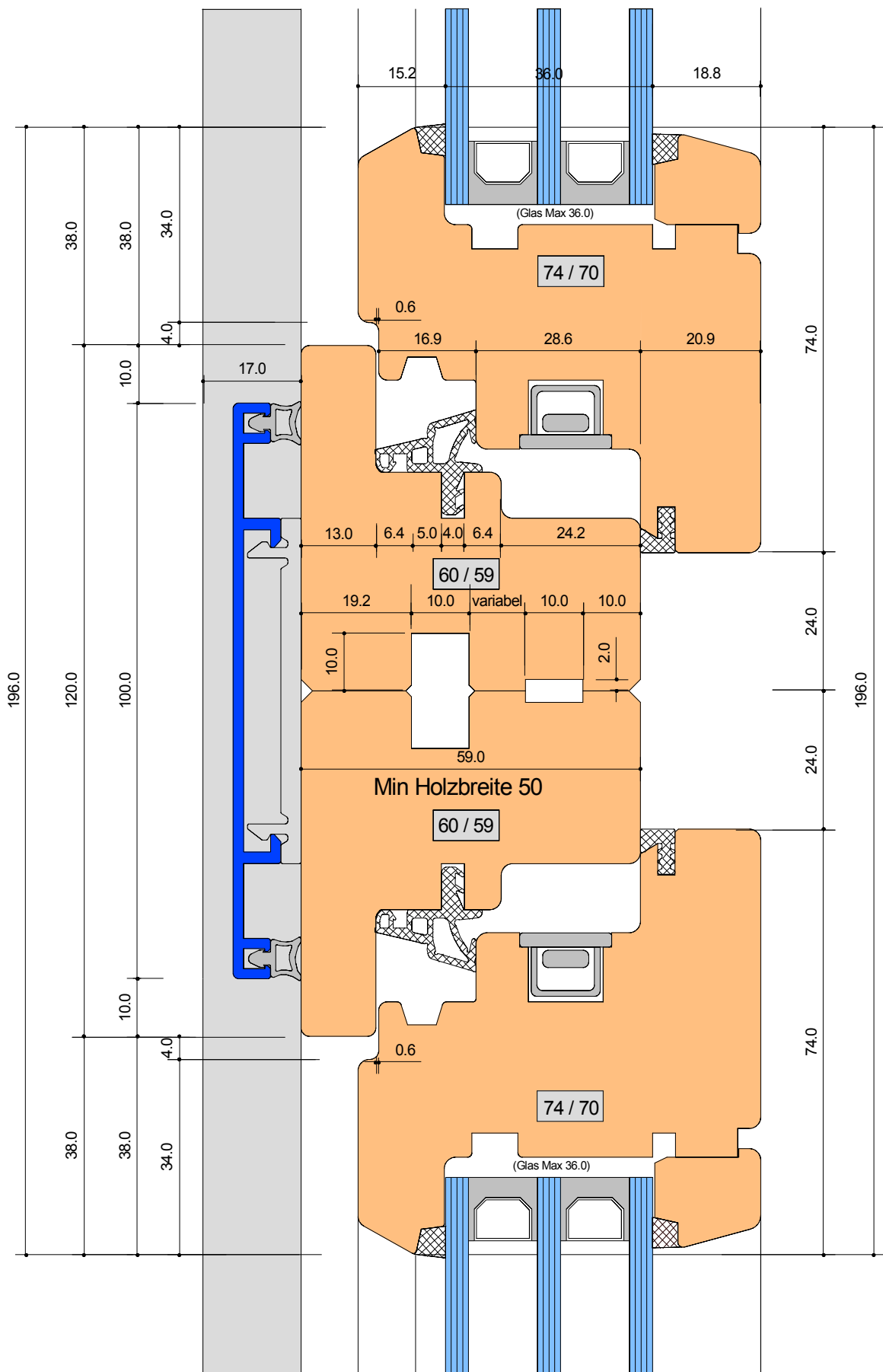

SYSTEM: H-0 59-70

Kombinationszusammenbau Nut + Feder

Detail-Nr : H - 0 D=405

Ersteller: Adi von Euw
 Datum: 16.06.14
 Revidiert:



Von Euw Fenster AG
 Schoosstrasse 2
 6418 Rothenthurm

Tel 041 839 80 50
 Fax 041 839 80 60
 mail info@voneuw.ch

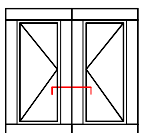

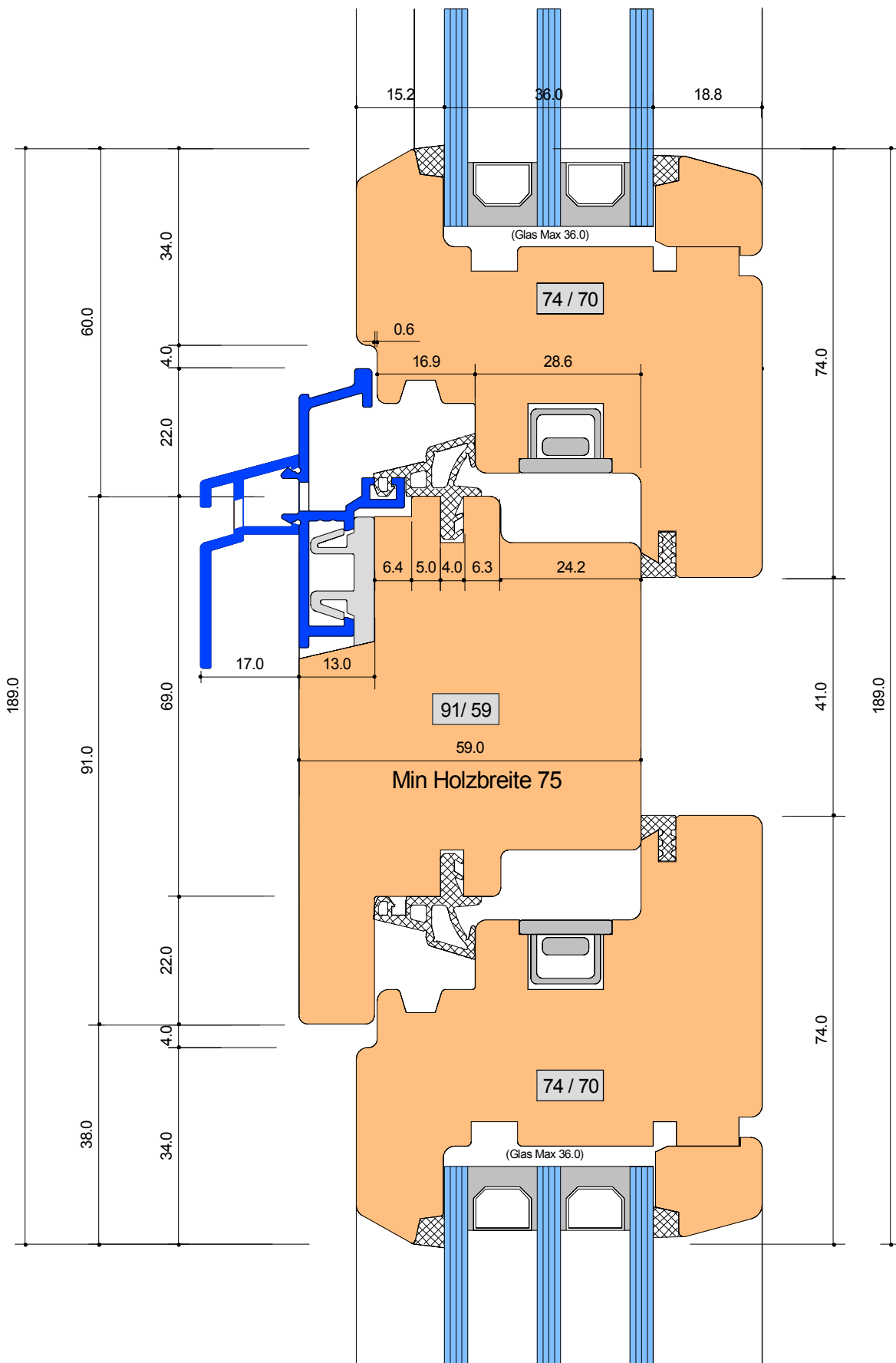

SYSTEM: H-0 59-70

Kämpfer

Detail-Nr : H - 0 D=501

Ersteller: Adi von Euw
Datum: 16.06.14
Revidiert:



Von Euw Fenster AG
Schoosstrasse 2
6418 Rothenthurm

Tel 041 839 80 50
Fax 041 839 80 60
mail info@voneuw.ch

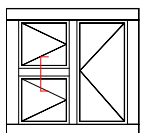

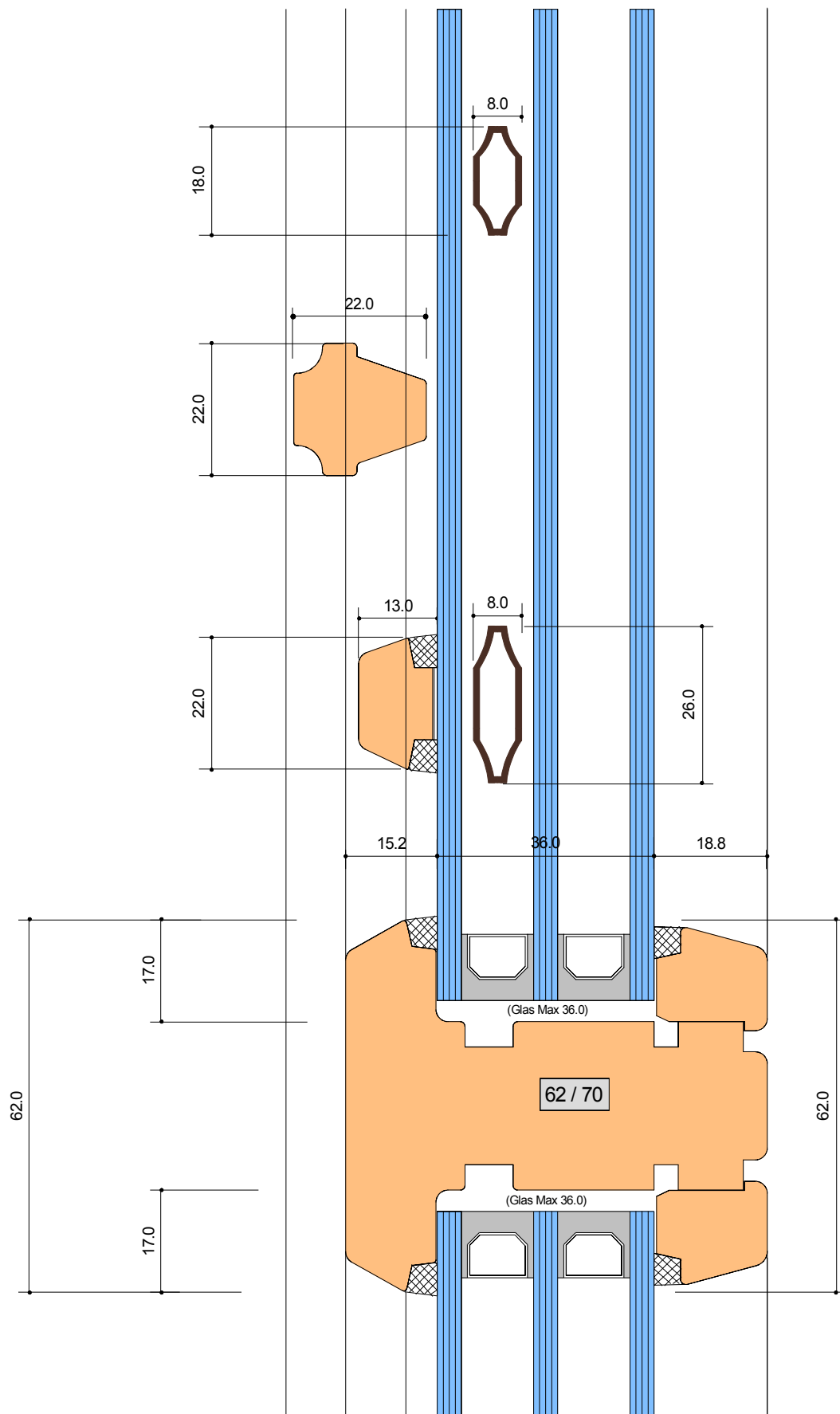

SYSTEM: H-0 59-70

Sprossen glastrennend 62 mm
 Vorgesetzte Holz-Spr. 22 +Zw.Glas Sprosse 26
 Vorgesetzte Klipp-Holz Spr. 22
 Zwischenglas -Sprosse 18 mm

Detail-Nr :	H - 0	D=601
-------------	-------	-------



Von Euw Fenster AG
 Schoosstrasse 2
 6418 Rothenthurm

Tel 041 839 80 50
 Fax 041 839 80 60
 mail info@voneuw.ch

Ersteller: Adi von Euw
 Datum: 16.06.14
 Revidiert:

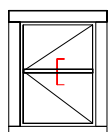

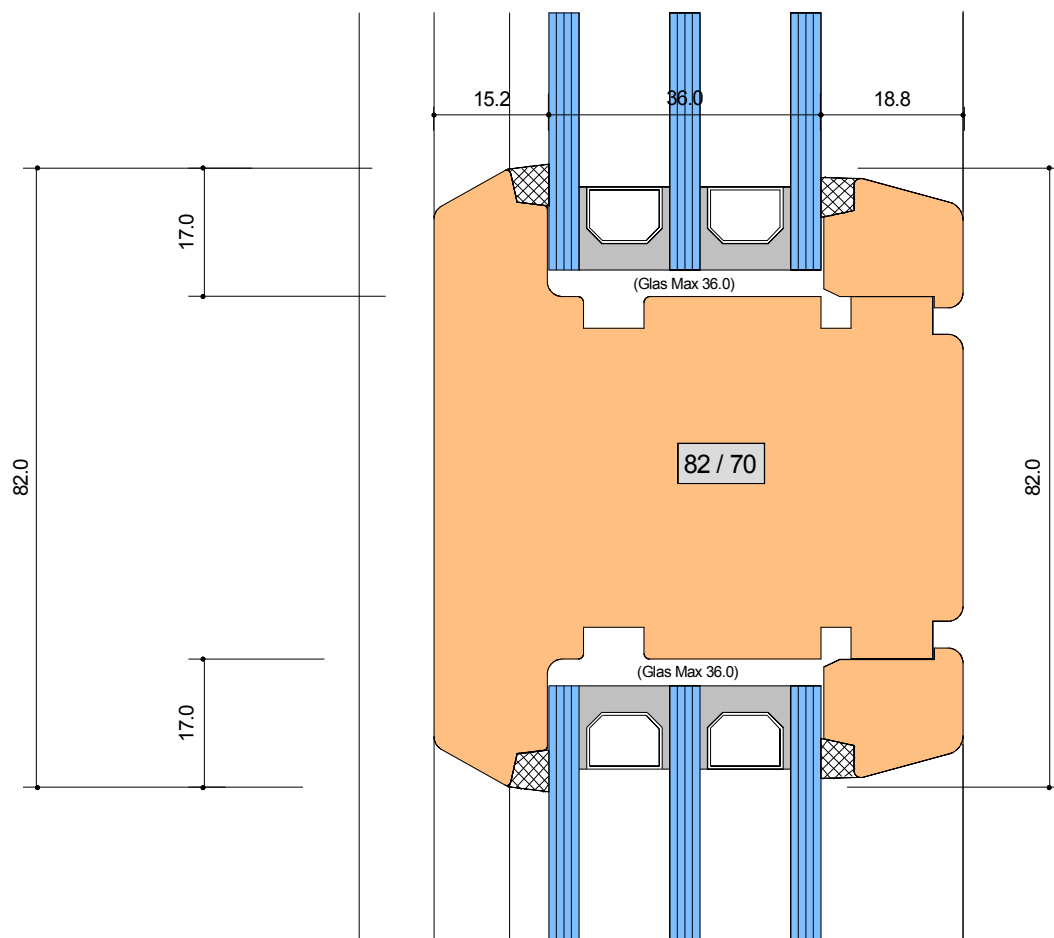

SYSTEM: H-0 59-70

Sprosse glastrennend 82 mm

Detail-Nr :	H - 0	D=602
-------------	-------	-------

Ersteller: Adi von Euw
 Datum: 16.06.14
 Revidiert:



Von Euw Fenster AG
 Schoosstrasse 2
 6418 Rothenthurm

Tel 041 839 80 50
 Fax 041 839 80 60
 mail info@voneuw.ch

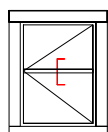

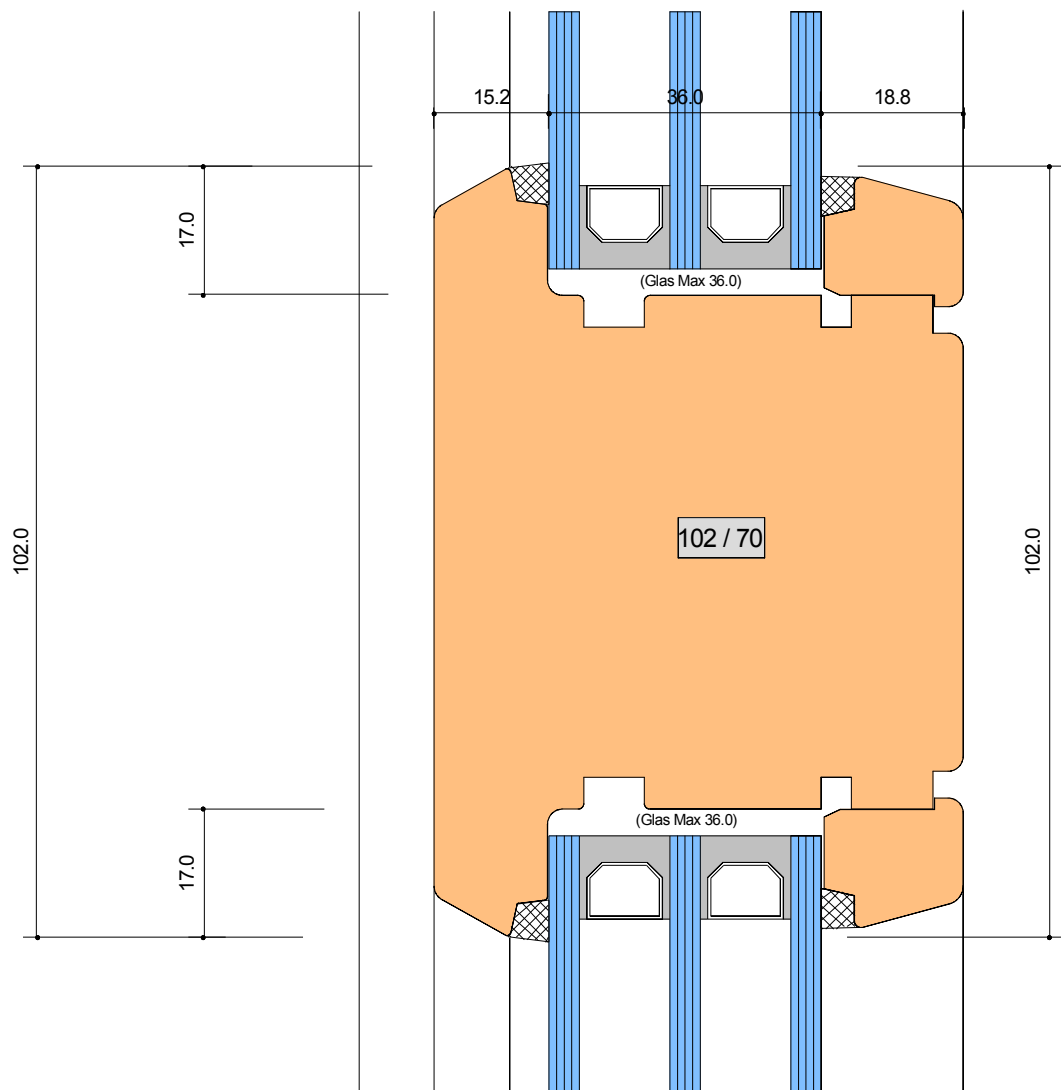

SYSTEM: H-0 59-70

Sprosse glastrennend 102 mm

Detail-Nr :	H - 0	D=603
-------------	-------	-------



Von Euw Fenster AG
Schoosstrasse 2
6418 Rothenthurm

Tel 041 839 80 50
Fax 041 839 80 60

mail info@voneuw.ch

Ersteller: Adi von Euw
Datum: 16.06.14
Revidiert:

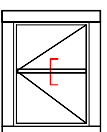

N69202 0.353 g/m1
 X1-ST 045-008 (roh+eloxiert)
 Fräsung 30.0 x 5.0 mm
 Abstand 125/25x250/125

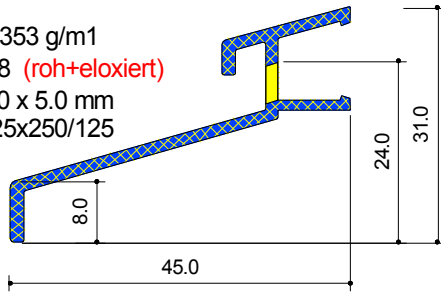

N74777 0.378 g/m1
 X1-ST 045-013 (roh+eloxiert)
 Fräsung 30.0 x 5.0 mm
 Abstand 125/25x250/125

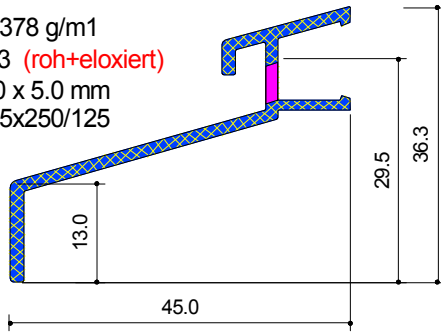

N70586 0.445 g/m1
 X1-ST 065-008 (roh+eloxiert)
 Fräsung 30.0 x 5.0 mm
 Abstand 125/25x250/125

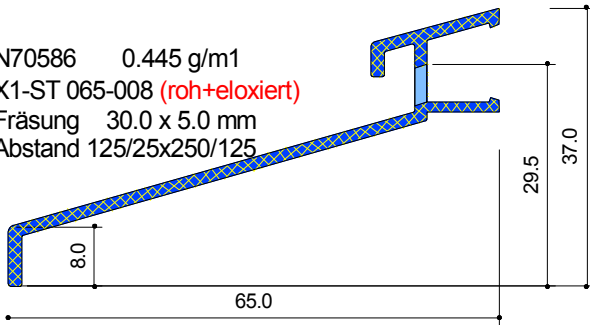

N74260 0.561 g/m1
 X1-ST 065-030 (eloxiert)
 Fräsung 30.0 x 5.0 mm
 Abstand 125/25x250/125

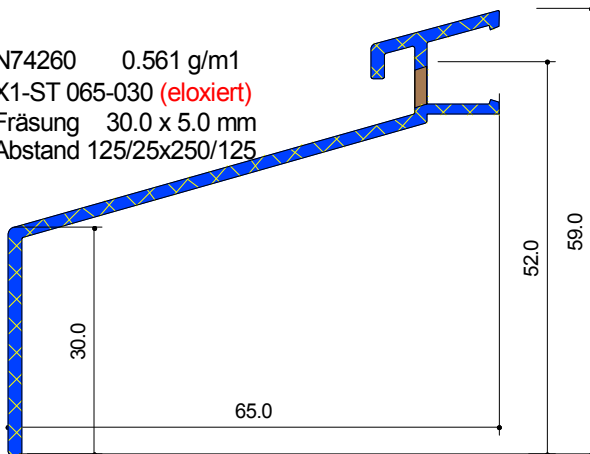

N70584 0.295 g/m1
 X1-ST 017-021 (eloxiert)
 Fräsung 30.0 x 5.0 mm
 Abstand 125/25x250/125

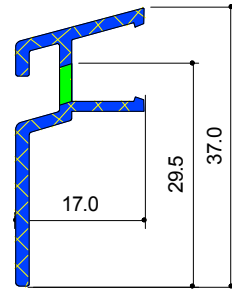

N70585 0.393 g/m1
 X1-ST 017-041 (eloxiert)
 Fräsung 30.0 x 5.0 mm
 Abstand 125/25x250/125

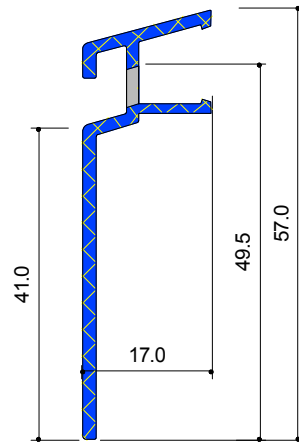

N74261 0.620 g/m1
 X1-ST 017-084 (eloxiert)
 Fräsung 30.0 x 5.0 mm
 Abstand 125/25x250/125

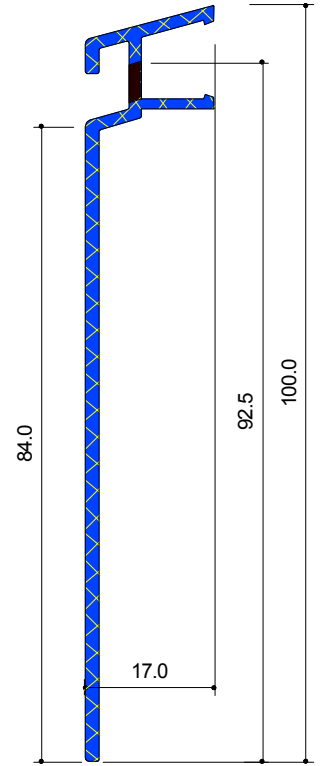

L49108 0.450 g/m1
 M1-GR 038-18 Roll (roh)
 Fräsung 30.0 x 5.0 mm
 Abstand 50/32x200/50

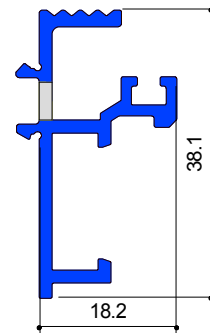

SYSTEM: *H, L, M, R*

Steckteil-Profilübersicht



Detail-Nr : A-1 D=100



Von Euw Fenster AG
 Schoosstrasse 2
 6418 Rothenthurm

Tel 041 839 80 50
 Fax 041 839 80 60
 mail info@voneuw.ch

Ersteller: Adi von Euw
 Datum: 11.10.19

-  Alu *roh* (Lager)
-  Alu *farblos elox.* (Lager)
-  Alu *Roh + farblos elox.* (Lager)